

# AIRCRAFT SERIOUS INCIDENT INVESTIGATION REPORT

NORTHWEST AIRLINES INCOPORATED  
BOEING 747-200B, N645NW  
ENGINE UNCONTAINED EVENT  
KANSAI INTERNATIONAL AIRPORT, JAPAN  
AT ABOUT 10:33 JST, JULY 29, 2004

March , 2006

Aircraft and Railway Accidents Investigation Commission  
Ministry of Land, Infrastructure and Transport

The investigation for this report was conducted by Aircraft and Railway Accidents Investigation commission, ARAIC, about the aircraft serious incident of Northwest Airlines Incorporated Boeing 747-200B in accordance with Aircraft and Railway Accidents Investigation commission Establishment Law and Annex 13 to the Convention of International Civil Aviation for the purpose of determining cause of the aircraft accident and contributing to the prevention of accidents and not for the purpose of blaming responsibility of the accident.

The English Version report has been published and translated by ARAIC to make its reading easier for English speaking people those who are not familiar with Japanese. Although efforts are made to translate as accurate as possible, only the Japanese version is authentic. If there is difference in meaning of the texts between the Japanese version and the English version, texts in the Japanese version are correct.

Junzo Sato,  
Chairman,  
Aircraft and Railway Accidents Investigation commission,

**AIRCRAFT SERIOUS INCIDENT INVESTIGATION  
REPORT**

**NORTHWEST AIRLINES INCOPORATED  
BOEING 747-200B, N645NW  
ENGINE UNCONTAINED EVENT  
KANSAI INTERNATIONAL AIRPORT, JAPAN  
AT ABOUT 10:33 JST, JULY 29, 2004**

March , 2006

**Decision by the Aircraft and Railway Accidents Investigation Commission  
(Air Sub-committee Meeting)**

<b>Chairman</b>	<b>Junzo Sato</b>
<b>Member</b>	<b>Yukio Kusuki</b>
<b>Member</b>	<b>Susumu Kato</b>
<b>Member</b>	<b>Sumio Matsuura</b>
<b>Member</b>	<b>Yukiko Kakimoto</b>
<b>Member</b>	<b>Akiko Matsuo</b>

# **AIRCRAFT SERIOUS INCIDENT INVESTIGATION REPORT**

## **NORTHWEST AIRLINES FLIGHT 905 BOEING 747-200B, N645NW UNCONTAINED ENGINE FAILURE KANSAI INTERNATIONAL AIRPORT, OSAKA PREFECTURE, JAPAN AT ABOUT 11:33 JST, JULY 29, 2004**

### **1. PROCESS AND PROGRESS OF THE SERIOUS INCIDENT INVESTIGATION**

#### **Summary of the Serious Incident**

This incident was treated as a serious incident coming under Civil Aeronautics Regulation Operating Standard Article 166 Section 4 Item 6 “Engine damage (limited to cases where broken fragments pass through the engine case)”.

On Thursday July 29, 2004, a Boeing 747-200B of Northwest Airlines (NWA), registration N645NW, departed Kansai International Airport Osaka Japan at 11:32JST operated as a scheduled cargo flight NWA905 to Incheon International Airport Seoul Korea. Just after taking off at around 11:33 local time, instrument indications showed an abnormal rise in the No. 1 (left outer) engine’s exhaust gas temperature, and because the No. 1 engine stopped, the aircraft returned to Kansai International Airport where it made an uneventful landed at 11:44.

After landing, damage was found to the lower cowl of the No. 1 engine.

There were three persons on board N645NW —the captain and two other crewmembers. There were no injuries to those on board.

## **1.2 Outline of the Serious Incident Investigation**

### **1.2.1 The Organization of the Investigation**

On July 30, 2004, the Aircraft and Railway Accidents Investigation Commission (ARAIC) assigned an investigator-in-charge and one another investigator with responsibility for investigating this serious incident, and an additional investigator was assigned on August 3, 2004.

### **1.2.2 Cooperation by Foreign Authorities**

An accredited representative of the United States of America, the state of design and manufacture of the aircraft and its engines, and the state of registration of the aircraft, participated in the investigation of this serious incident.

### **1.2.3 The Implementation of the Investigation**

The investigation was proceeded as follows.

July 30~August 1, 2004	Investigation of the aircraft and collection of witness statements.
------------------------	---

August 3, 2004~May 31, 2005	DFDR and CVR analysis
-----------------------------	-----------------------

August 17, 2004~March 17, 2005	Detailed engine investigation
--------------------------------	-------------------------------

(The US National Transportation Safety Board (NTSB) cooperated in this analysis.)

### **1.2.4 Interim Report**

On September 30, 2005, the ARAIC submitted an interim report based on the results of the factual investigation to the Minister for Land, Infrastructure and Transport, and it was made public on the same day.

### **1.2.5 Hearing from Persons relevant to the Cause of the Serious Incident**

Hearings were held.

### **1.2.6 Comments Inquiry from the State of the Design and Manufacture**

Hearings were held

## 2 FACTUAL INFORMATION

### 2.1 Flight History

On July 29, 2004, the aircraft was planned to operate as Northwest Airlines (NWA, the company) scheduled cargo flight 905 from Kansai International Airport to Incheon International Airport.

According to the captain and a company mechanic, no anomalies were found during the preflight checks.

The flight plan of the aircraft submitted to the Kansai International Airport Office of the Civil Aviation Bureau was as follows:

FLIGHT RULES: IFR, DEPARTURE AERODROME: Kansai International Airport, EOBT: 11:30, CRUISING SPEED: 495kt, CRUISING ALTITUDE: FL390, ROUTE: MAIKO (reporting point) ~ Y32 (air route) [remainder omitted], DESTINATION AERODROME: Incheon International Airport, TOTAL ESTIMATED EN-ROUTE TIME: 1 hour and 20 minutes.

On board the aircraft, the captain assumed Pilot Flying (PF: the pilot responsible for controlling the aircraft) duties from the left pilot seat and the first officer assumed Pilot Not Flying (PNF: the pilot responsible for duties other than control of the aircraft) duties from the right pilot seat. The flight engineer assumed his duties from the flight engineer's seat.

Below is a summary of the progress of the flight up to the occurrence of the serious incident based on the statements of the captain, the first officer, the flight engineer and an air traffic controller in the control tower of Kansai International Airport (Kansai Tower) who witnessed the aircraft.

#### (1) The captain

"I confirmed the maintenance condition of the aircraft, and started the engines in the order No. 4, No. 1, No. 2 and No. 3. The No. 4 engine started normally, but the No. 1 engine revolutions did not stabilize after startup, so I shut it down and then restarted it. The operating manual stipulates that a restart should be conducted after the Exhaust Gas Temperature (EGT) has fallen below 100°C, so I confirmed the EGT and then restarted the engine. The engine did not behave this way at the previous departure airport, but we sometimes have to perform restarts.

"After the restart the No. 1 engine's revolutions stabilized, so I started the No. 2 engine but, like the No. 1 engine, its revolutions did not stabilize after startup so I shut it down and then restarted it. It stabilized after the restart, so I then started the No. 3 engine.

"After startup, all the engines were stable until take-off.

“I raised the nose, and when we reached an altitude of 300ft, I heard a rasping noise and there was a yawing and the nose skewed to the left, so I checked the engine instruments and confirmed that the No. 1 engine had lost thrust.

“I stabilized the aircraft and kept the wings level, then climbed to 1,000ft. The No. 1 engine had stopped, so we carried out the engine failure drill.”

(2) The first officer

“I checked the maintenance log, then started the engines with the captain. The revolutions of the No. 1 and No. 2 engines did not stabilize after start-up, so they were restarted. I confirmed that the EGT indications were below 100°C before restarting.

“All engines were normal from start-up until the trouble occurred at take-off, and the instrument indications were normal.

“After we had lifted off, there was a loud noise and a yawing, and a drop in Engine Pressure Ratio (EPR), and I recognized it as an abnormal situation.

“Kansai Tower asked us whether we were OK, and I replied that we had engine trouble and wished to return to Kansai International Airport. We were radar vectored to the ILS final approach course and landed.”

(3) The flight engineer

“I checked the maintenance log and carried out the external checks.

“The No. 1 and No. 2 engine revolutions did not stabilize at start-up, so they were restarted. The pilots were monitoring the EGT and engine rotation speed instruments, but I was watching the pneumatic pressure, engine oil pressure, fuel flow, and other instruments on flight engineer’s panel. I could not see that the engine rotations were not stabilized on the instruments I was monitoring. If a restart is normal there is no problem.

“All instrument indications were normal until the trouble occurred.

“There was a loud noise followed by a yawing and a drop in thrust. The No. 1 engine’s EGT rose while its rotation speed and oil pressure decreased, but fuel flow was normal. There were no indications of fire, and the nacelle temperature was also normal.”

(4) An air traffic controller of Kansai Tower

“The aircraft reported that it had completed preparations for take-off while it was taxiing. There was no traffic so I cleared it for take-off. The wind was 11kt at 10°. Runway 06 was in use, and after confirming take-off, I reported the take-off time to Approach. After that, I took my eyes off the aircraft, but two other controllers (seated in the Clearance Delivery and assistant controller positions) said they saw flames being emitted, so I looked at the aircraft. When I saw the aircraft I heard a bang but

did not see any flames or smoke. I asked the aircraft ‘is everything normal?’. I didn’t hear the first reply very well so I asked them to retransmit, and they declared an emergency due to engine trouble, so I asked their intentions. The aircraft replied ‘we have a problem, let us fly straight a little while’, and after that it asked to return to Kansai International Airport, so I coordinated with Approach. The aircraft was radar vectored in a short pattern and landed on runway 06. After landing, it taxied to its parking area under its own power.”

This serious incident occurred at an altitude of around 300ft above ground level over the runway at Kansai International Airport just after take-off at around 11:33.

(See Figure 1 and Photograph 1)

## **2.2 Injuries to Persons**

There were no injuries.

## **2.3 Damage to Aircraft**

An inspection of the aircraft found no damage except to the No.1 engine, a P&W JT9D-7R4G2 SN 715257. The damage condition of the No.1 engine is detailed below.

### **(1) Engine Cowling**

At approximately the 5 o’clock position (**Note 1**), there was key-shaped damage 3cm width, 11cm length and 8cm length at one location and four holes of around 1cm in diameter in the engine cowling.

### **(2) Exterior of the Engine Case**

The high-pressure turbine (HPT) case exhibited an approximately 4cm by 2cm hole just forward of the HPT-to-low pressure turbine (LPT) case attachment flange at approximately the 5 o’clock position.

There was damage to the case cooling manifold, which is on the outside of the case, at the 5 o’clock position.

Some metal flakes that had melted and then solidified were adhered to the engine exhaust outlet.

---

Note 1: The clock position is aft looking forward

(See Photographs 2 and 3)



## 2.4 Damage to Other than the Aircraft

There was no damage except to the aircraft

## 2.5 Crew Information

### (1) Captain: Male aged 52

Airline Transport Pilot License	Issued October 19, 2001
Type Ratings	
Airplane multiengine (land)	
Boeing 747	
Class 1 Airman Medical Certificate	
Term of Validity	Until September, 2004
Total flight time	6,001 hours 26 minutes
Flight time during the previous 30 days	32 hours 22 minutes
Total flight time on Boeing 747	3,327 hours 18 minutes

### (2) First Officer: Male aged 45

Airline Transport Pilot License	Issued August 24, 1987
Type Ratings	
Airplane multiengine (land)	Issued February 25, 1994
Boeing 747	Issued February 15, 1995
Class 1 Airman Medical Certificate	
Term of Validity	Until July, 2005
Total flight time	6,254 hours 57 minutes
Flight time during the previous 30 days	62 hours 35 minutes
Total flight time on Boeing 747	2,627 hours 20 minutes

### (3) Flight Engineer: Male aged 49

Flight Engineer License (airplane)	Issued August 21, 2001
Type Ratings	
Airplane turbojet-engine	
Class 1 Airman Medical Certificate	
Term of Validity	Until August, 2004
Total flight time	5,445 hours 33 minutes
Flight time during the previous 30 days	20 hours 53 minutes
Total flight time on Boeing 747	4,484 hours 15 minutes

## 2.6 Aircraft Information

### 2.6.1 Aircraft

Type	Boeing 747-200B
Serial number	23736
Date of manufacture	March 19, 1987
Certificate of Airworthiness	
Date of Issue	July 5, 2000
Total flight time	59,476 hours 55 minutes
Flight time since scheduled maintenance “L2” Check on March 18, 2004	1,302 hours 55 minutes

### 2.6.2 Engines

#### (1) Service Conditions

Engine No.	1	2	3	4
Type	Pratt and Whitney JT9D-7R4G2			
Serial number	715257	715233	715278	715251
Date of manufacture	March 27, 1987	November 20, 1986	August 19, 1987	March 13, 1987
Total flight time	54,489 hours 54 minutes	51,797 hours 03 minutes	48,258 hours 44 minutes	40,201 hours 02 minutes
Flight time since overhaul	13,017 hours 11 minutes	13,790 hours 30 minutes	16,891 hours 16 minutes	1,439 hours 49 minutes

#### (2) Maintenance History of the No. 1 engine

The engine was overhauled on October 28, 2000 at an NWA facility.

After that, the engine was installed twice on other aircraft. On September 25, 2003, the engine was removed from an aircraft, the fuel control unit, etc. were replaced, and after a test run, was stored.

The engine was installed on the aircraft on December 14, 2003.

(See Figure 3)

### 2.6.3 Weight and Center of Gravity

The aircraft's weight at the time of the serious incident was estimated as approximately 545,560lb, with the center of gravity at 24.7% MAC, both values being within the allowable limits (maximum take-off weight 833,000lb, with the allowable center of gravity range corresponding to the weight at the time of the serious incident of 13.0~31.5% MAC).

### 2.6.4 Fuel and Lubricating Oils

The fuel on board was JET-A-1. The lubricating oil was Mobil Jet Oil II.

## 2.7 Metrological Information

The aeronautical meteorological observations by the Kansai International Airport Office at around the time of the serious incident were as follows:

Time of Observation	11:30 JST
Wind Direction	010°
Wind Speed	9kt, wind variable 330° ~050°
Visibility	Over 10km
Cloud Amount	1/8
Cloud Type	Cumulus
Height of Cloud Base	2,500ft
Cloud Amount	3/8
Cloud Type	Cumulus
Height of Cloud Base	4,000ft
Cloud Amount	7/8
Cloud Type	Stratocumulus
Height of Cloud Base	6,000ft
Temperature	32°C
Dew Point	24°C
Altimeter Setting (QNH)	29.78inHg

## 2.8 Information on the Digital Flight Data Recorder and Cockpit Voice Recorder

The aircraft was equipped with a Lockheed Aircraft Service Digital Flight Data Recorder (DFDR), P/N 10077A500-107, and an Allied Signal Cockpit Voice Recorder (CVR), P/N 980-6020-001.

The DFDR can record for 25 hours, and the CVR for 2 hours, with recordings beyond those times being overwritten. Of the approximately 90 minutes of newly-recorded data on the DFDR, including the time of the serious incident occurrence, erroneous data were recorded for approximately 55 minutes, and no data were recorded during a period of approximately 35 minutes. Regarding the CVR, because no action had been taken to stop the recorder, recordings for the time period relating to the serious incident had been overwritten and erased.

## 2.9 Tests and Research to Find Facts

### 2.9.1 Engine Teardown Inspection

To investigate the cause of the serious incident, a teardown inspection of the No. 1 engine concentrating on the turbine section was conducted at a NWA facility in Minneapolis, Minnesota, U.S.A., witnessed by an NTSB investigator. The main findings of the teardown inspection are as follows:

#### HPT Section

- (1) Twenty four 2<sup>nd</sup> stage turbine blades were fractured at various lengths, and their outer shrouds were missing. Four blades were fractured at the blade platform.

All the 2<sup>nd</sup> stage turbine blades exhibited a combination of leading edge impact damage, gouging, tears and missing material and all trailing edges exhibited minor impact damage.

- (2) All the 2<sup>nd</sup> stage turbine blade outer air seal segments exhibited impact damage and almost all the honeycomb was worn away. Four consecutive seal segments, located in the vicinity of the 5 o'clock position, exhibited the worst damage. Two of the seal segments exhibited holes, one exhibited a deep trenching, and one was worn completely through the entire thickness.
- (3) The 2<sup>nd</sup> stage turbine inner air seal segments aft portion was heavily damaged. Five of the segments of the stationary seal were completely missing the aft end, and all of the honeycomb was rubbed away in the area. The forward part of the stationary seal also exhibited deep gouging of the honeycomb, but areas of honeycomb did remain.

The lenticular seal (**Note 2**) was fractured and not fully engaged with the inner brace at two locations. The lenticular seal exhibited a 21.75-inch circumferential crack that progressed through the 4<sup>th</sup> (**Note 3**) and 5<sup>th</sup> seal teeth. The crack ran roughly through the axial center of the seal. An approximately 17.5-inch

circumferential section of seal rear axial half was missing. An axial crack was noted through the front portion of the seal but did not progress into the flange portion. The axial crack was located roughly centered where the aft half was missing.

Note 2: The Lenticular Seal is a component installed between 1<sup>st</sup> HPT disc and 2<sup>nd</sup> HPT disc that, along with the inner air seal, prevents leakage of combustion gases along the turbine shaft.

Note 3: The “4<sup>th</sup>” identifies one of the five teeth in the lenticular seal, numbered from forward to back.

(See Figure 3 and Photographs 4, 5 and 6)

### **2.9.2 Detailed Examination of the Lenticular Seal, etc.**

The following is a summary of the result of an examination of the severely damaged lenticular seal and inner brace by the NTSB materials laboratory,

(1) The lenticular seal was missing a large section of the aft flange up to seal tooth No. 2 between the 12 and 3 o'clock position, measuring approximately 18 inches in length and around 2 inches in width. However, sections of the seal remote from the missing area were little damaged and in relatively good condition.

The inner brace was deformed significantly in two places and was uncoupled from the lenticular seal. A large axial crack propagated in the 1:30 position of the lenticular seal.

(2) While the nominal thickness of the lenticular seal barrel between the teeth is approximately 0.106 inches, significant non-uniform circumferential rubbing was found on the barrel, and near the missing portion of the seal the minimum thickness was measured at about the 1:30 position, where the barrel was thinned down to approximately 0.024 inches at several locations. At this location, an axial crack approximately 1.1 inches long was observed.

(3) Visual examination revealed that a small region of circumferential fracture in the rub area between tooth No. 2 and No. 3 was on a flat plane, indicative of fatigue cracking. Scanning Electron Microscope (SEM) examination of this region showed the fracture had a thumbnail shape and was entirely intergranular, consistent with high temperature fatigue.

The cracking extended from the outer diameter (OD) surface in the heavily rubbed region toward the inner diameter (ID).

(4) The axial crack extended from the rub areas toward the forward flange. The fracture

surface adjacent to the rub areas showed very rough features with significant voiding, consistent with high temperature rupture.

- (5) The fracture surface features of the larger circumferential fracture areas near teeth No. 3 and No. 4 were fairly rough. SEM examination revealed features consistent with high temperature rupture near the OD surface in the area of heavy rubbing.

The metal composition in the axial cracking areas is consistent with the engine design specification of improved INCOMNEL 100 powder (PWA 1100 alloy).

- (6) Multiple axial cracks were observed at the tips of the teeth No. 1 and No. 4. These cracks appeared to have initiated from the tips of the seal teeth. SEM examination showed the fracture features to be entirely intergranular cracking, consistent with high temperature fatigue.

(See Photograph 7, 8, 9 and 10)

### **2.9.3 The History of the Lenticular Seal**

The ruptured lenticular seal (P/N 815097, S/N AKLBL6830) was newly assembled onto the turbine module during engine overhaul on October 28, 2000.

According to maintenance records, the clearance between the lenticular seal and the brace was within limits at the time of assembly.

The total time in service and total number of cycles until the serious incident occurred were 13,017 hours and 1,973 cycles. The life of the lenticular seal is 15,000 cycles. Although the condition of the lenticular seal maybe confirmed during disassembly in a workshop, there had been no workshop disassembly since October 28, 2000.

### **2.9.4 Lenticular Seal Problems**

According to the engine manufacturer, there has been a single previous occurrence of a similar event on the same engine model, where ruptured lenticular seal fragments remained inside the engine.

### **2.9.5 Cooling of the Lenticular Seal**

Bleed air from the high pressure compressor flows from along the inside of the high pressure turbine case through the HPT 2<sup>nd</sup> nozzle guide vane, cooling the nozzle guide vanes, and passes from the vane nozzle through the inner air seal to impinge on and cool the lenticular seal.

A service bulletin was issued by the engine manufacturer on June 14, 1985, which altered the shape of vane nozzle to reduce the cooling air flow. This was the shape of the

vane nozzle in the engine which failed in the serious incident.

(See Figure 3 and 4)

## **2.10 DFDR Data**

Because the DFDR contained erroneous data and some data were not recorded by the DFDR, as described in paragraph 2.8, the ARAIC requested NWA to examine the aircraft's flight data acquisition unit (FDAU: **Note 4**) and DFDR. The result of the examination is summarized as follows.

According to NWA, scheduled checks of the FDAU and DFDR were conducted at 18 month intervals with the units installed in the aircraft. The most recent check before the serious incident had been carried out in March, 2004, and no anomaly had been found.

- (1) At the time of the serious incident, there was no discrepancy on the recordings from the other DFDR installed on the aircraft until the time when the DFDR was installed on the aircraft.
- (2) There had been no problem with the recordings of the DFDR when it had been installed in other aircraft prior to being installed on the aircraft to which the serious incident occurred.
- (3) There was no problem with the FDAU which was installed on the aircraft at the time of the serious incident.

---

Note 4: The FDAU is a unit that receives signals from the aircraft sensors and systems, converts them and transmits them to DFDR.

## **2.11 Other Information**

An inspection of the runway, taxiways etc. after the aircraft had made an emergency landing found no fragments of engine parts relating to the serious incident.

# **3 ANALYSIS**

## **3.1 Crew Qualifications**

The captain, first officer and flight engineer had valid airman proficiency certificates and valid airman medical certificates in accordance with applicable regulations.

### **3.2 Aircraft Certificate of Airworthiness**

The aircraft had a valid certificate of airworthiness and had been maintained in accordance with applicable regulations.

### **3.3 Contribution of Weather**

It is estimated that the weather conditions at the time of the serious incident did not contribute to the serious incident.

### **3.4 Turbine Case Damage**

It is estimated that the holes in the turbine case were made when parts of the damaged and separated lenticular seal and/or ruptured turbine blades impacted the turbine case and passed through it.

### **3.5 Turbine Blade Damage**

From the impact damage traces on the second stage turbine blades described in paragraph 2.9.1(1), it is estimated that this damage was the result of the impact of ruptured 2<sup>nd</sup> stage turbine blade fragments and damaged portions of the lenticular seal.

### **3.6 Damage to the Turbine Inner Air Seal and Outer Air Seal**

Since various sections of honeycomb were found to be worn as described in paragraph 2.9.1(1), it is estimated that the damage to the 2<sup>nd</sup> stage turbine vane inner airseal and the 2<sup>nd</sup> stage turbine blade outer airseals were the result of damaged lenticular seal and ruptured turbine blade fragments lodging between the lenticular seal and inner air seal, and between the turbine blades and the outer air seal, and being carried round.

### **3.7 Lenticular Seal Damage**

It is estimated that the cracks in the lenticular seal were the result of high temperature fracture and propagated from the surface to the interior, as described in paragraph 2.9.2.

It is estimated that initiation of the high temperature fatigue was the result of heat stresses due to insufficient cooling combined with the centrifugal force on the lenticular seal, and this caused repeated deformation of the inner brace and the lenticular seal which were attached between the turbine 1<sup>st</sup> and 2<sup>nd</sup> stage turbine disc.

### **3.8 Lenticular Seal Material Composition and Assembly**

As described in paragraphs 2.9.2 and 2.9.3, it is estimated that there was no anomaly with the material of the lenticular seal, and no discrepancies regarding its



assembly.

### **3.9 The Errors in DFDR Data**

From the result of the examination described in paragraph 2.10, it is estimated that there was no problems with the DFDR and FDAU installed on the aircraft.

Regarding the problems with the recorded data, including the fact that data relating to the serious incident were not obtained, is considered possible that a temporary FDAU fault affected the DFDR recordings, but the cause could not be ascertained.

### **3.10 The Flames Emitted from the Engine**

As described in paragraph 2.1(4), air traffic controllers in Kansai Tower witnessed flames engulfing the engine and heard a bang. It is estimated that these were the result of a momentary abnormal combustion and abnormal flow of combustion gases caused by the occurrence of the serious incident.

## **4. PROBABLE CAUSE**

In this serious incident, the probable cause was that while the aircraft was climbing, the lenticular seal of the HPT section of the No.1 engine was failed and, a portion of the lenticular seal separated, impacting the turbine blades allowing broken fragments of the lenticular seal and/or turbine blades to exit through the engine case.

It is considered that the damage to the lenticular seal was the result of heat stress due to insufficient cooling causing a crack to initiate and grow.

## **5. SAFETY RECOMMENDATIONS**

In consideration of this serious incident, the ARAIC recommends to the Federal Aviation Administration, United States of America that Pratt and Whitney should examine the following item and take appropriate measures.

- Measures should be taken to ensure that there is no insufficiency of cooling of the lenticular seal of JT9D-7R4 series engine.

Figure 1 Presumed Flight Route

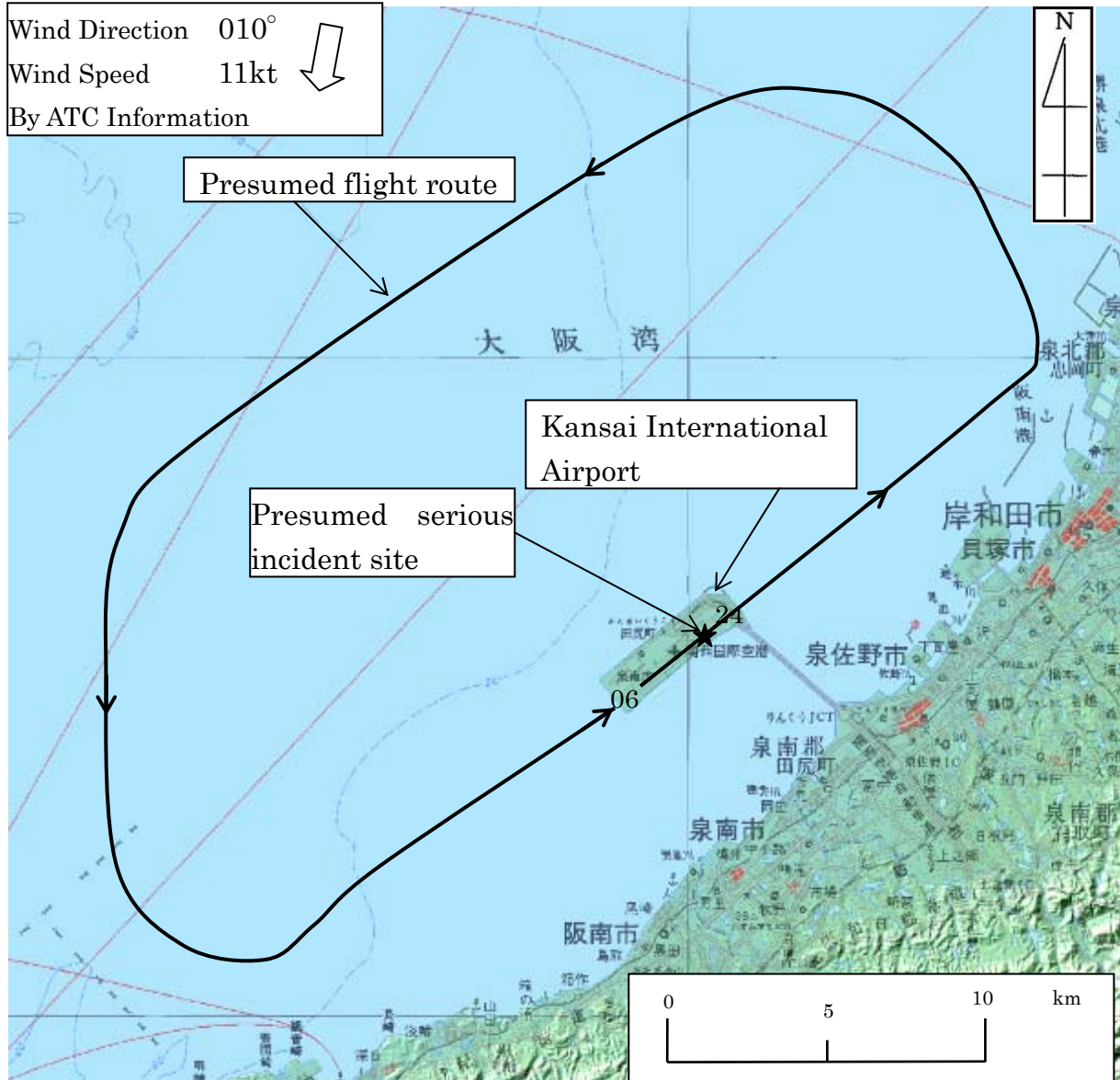
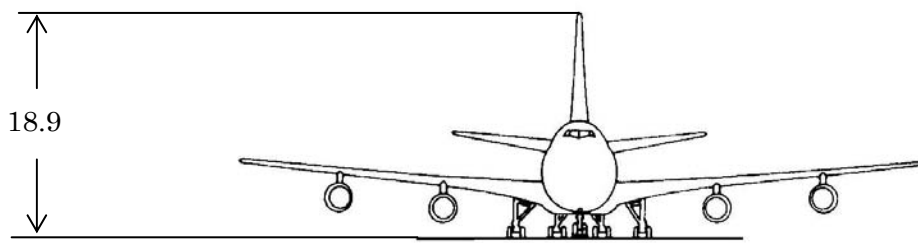

Figure2 Boeing 747-200B Three Angle View



Unit : m

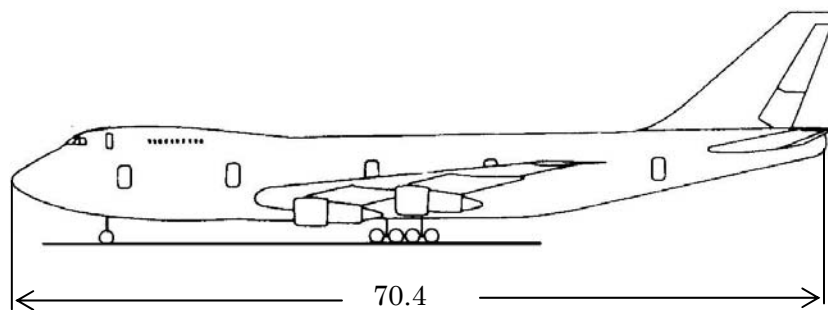
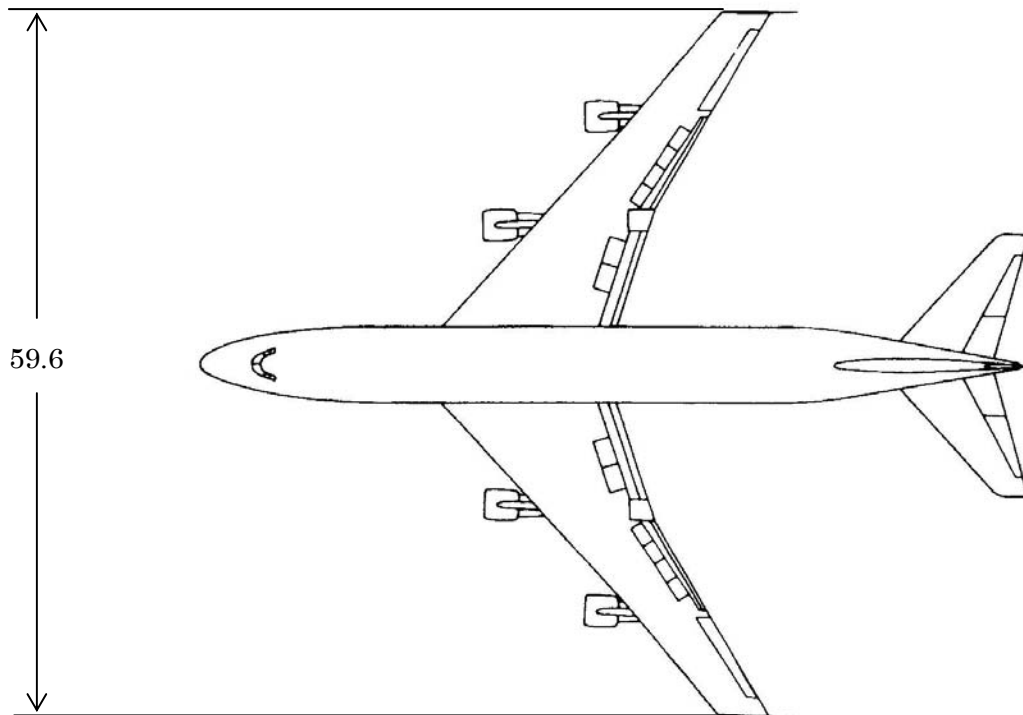

Figure 3 High Pressure Turbine Outline

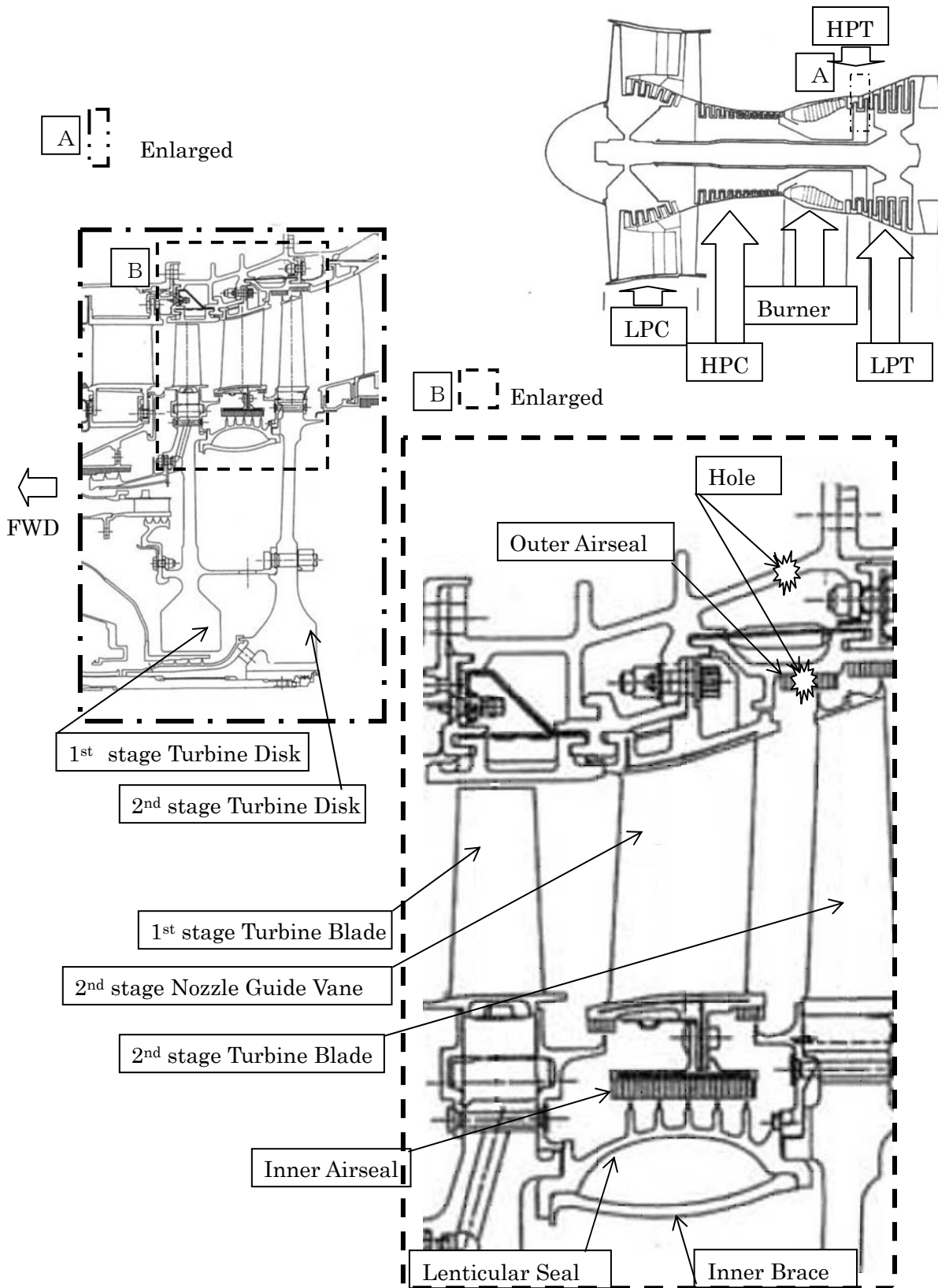
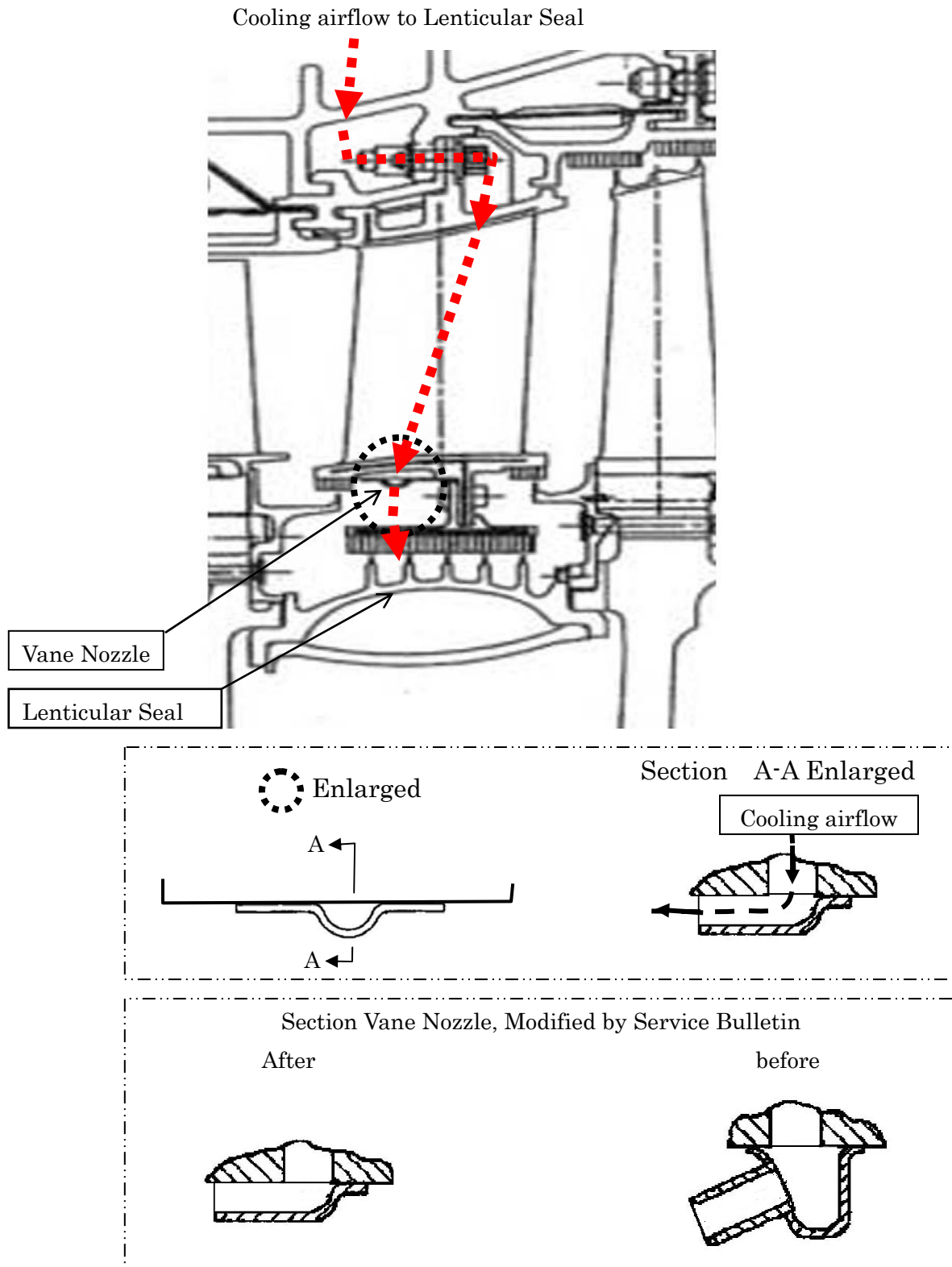

Figure 4 Cooling Airflow and Vane Nozzle



Photograph 1 Boeing 747-200B (N645NW)



Photograph 2 Holes on #1 Engine Cowling

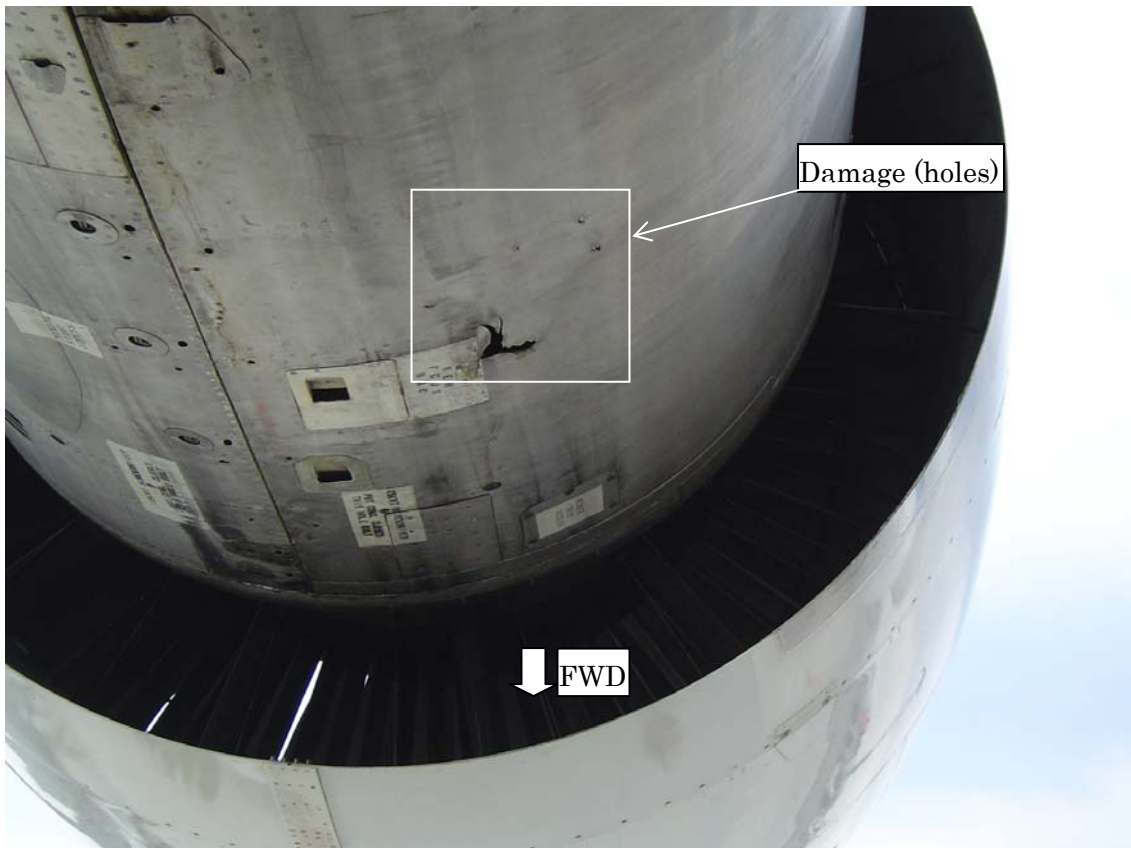



Photograph 3 Engine Case Fractures

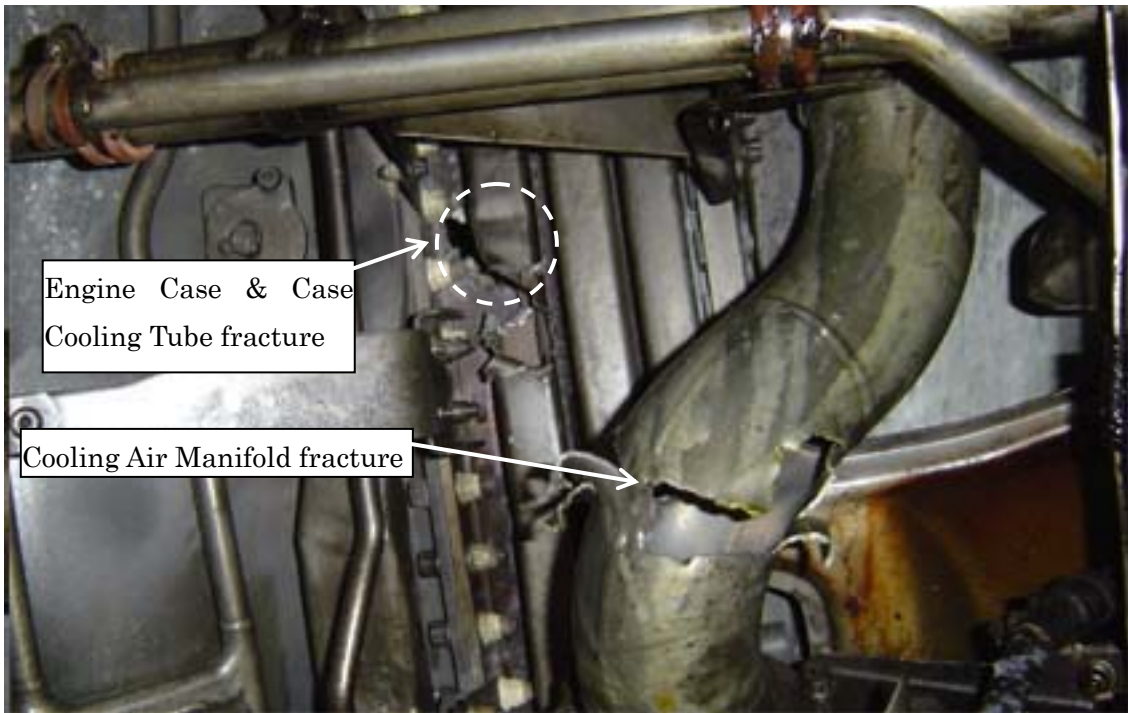

Photograph 4 Outer Airseal Fracture

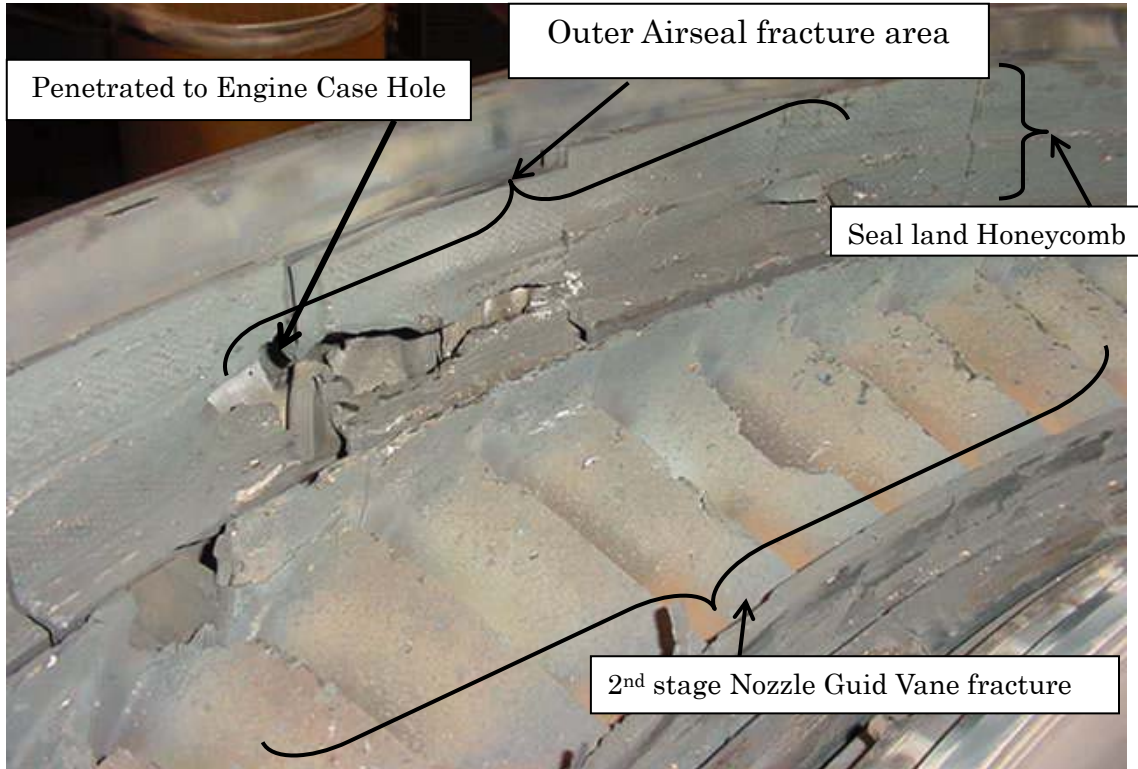

Photograph 5 2<sup>nd</sup> Stage Turbine Blade of High-Pressure Turbines & lenticular Seal Fracture

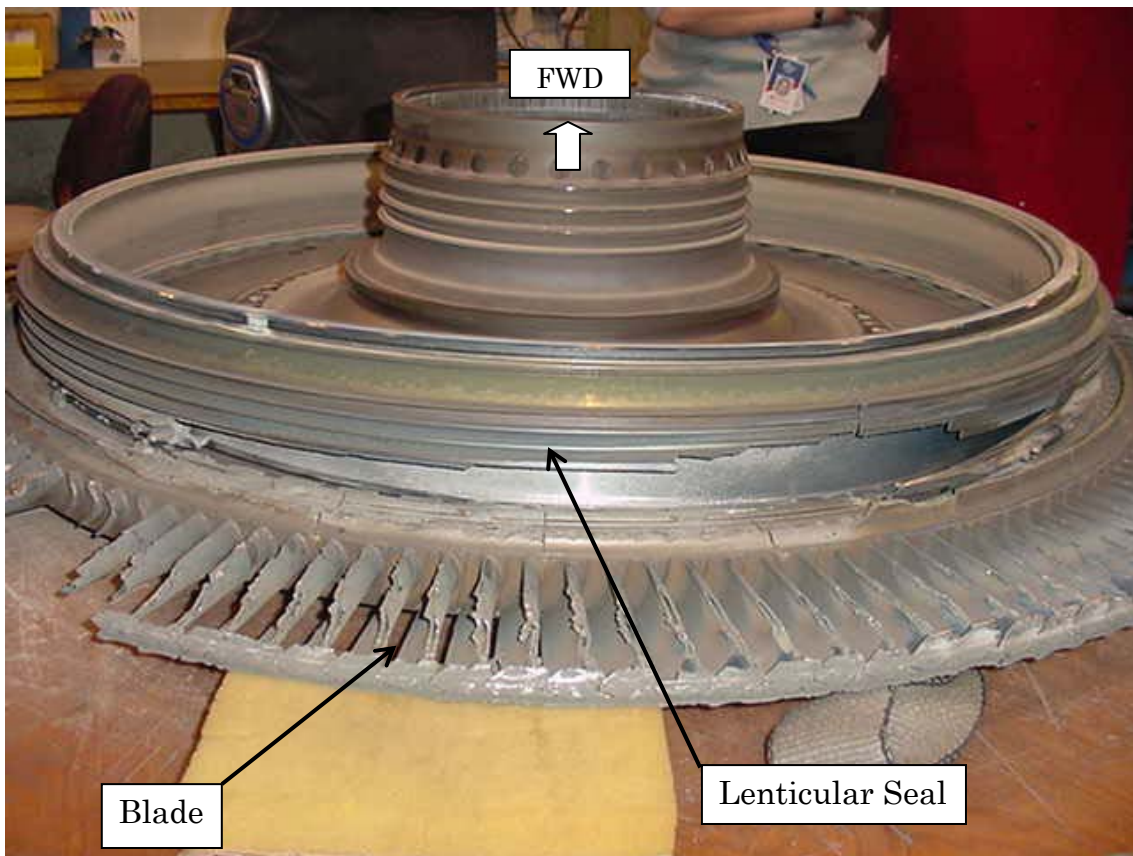

Photograph 6 Turbine Blade of High-Pressure Turbines 2<sup>nd</sup> Stage





# Photograph 7 Lenticular Seal Cracks

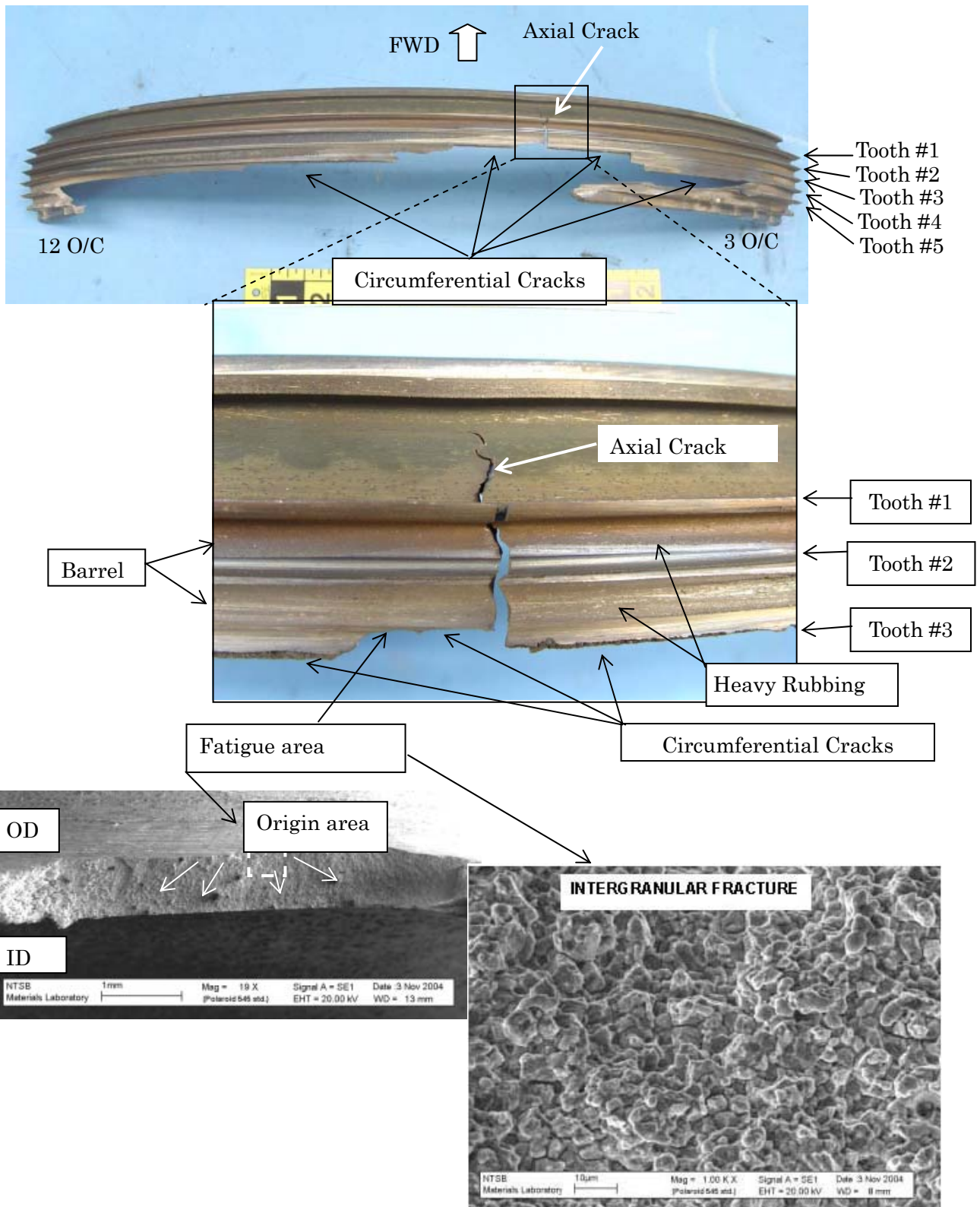

# Photograph 8 Lenticular Seal Tooth #1 Axial Crack

2 o'clock position Axial Crack  
Approximately 0.3 inch long

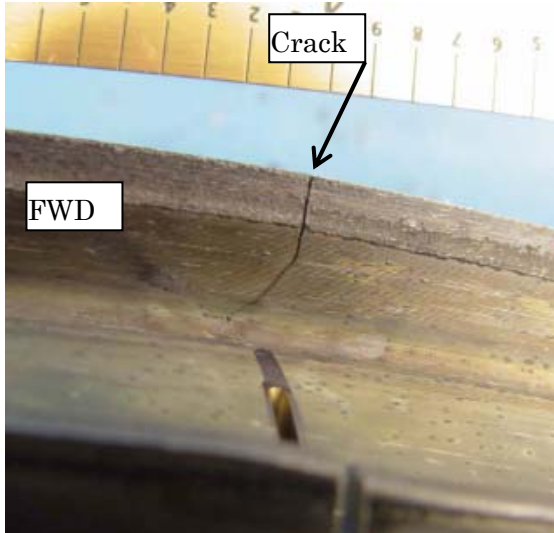

Enlarged

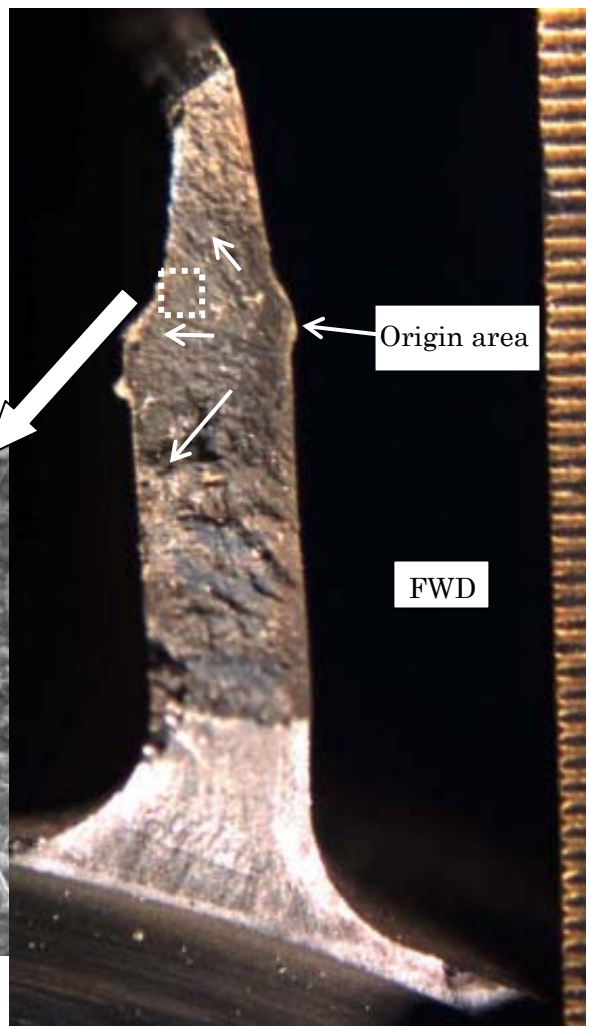
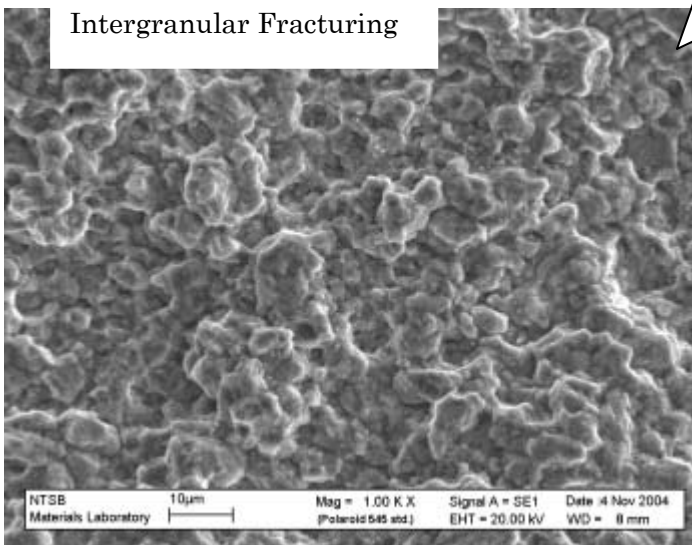

Photograph 9 Lenticular Seal Tooth #1 Cracks

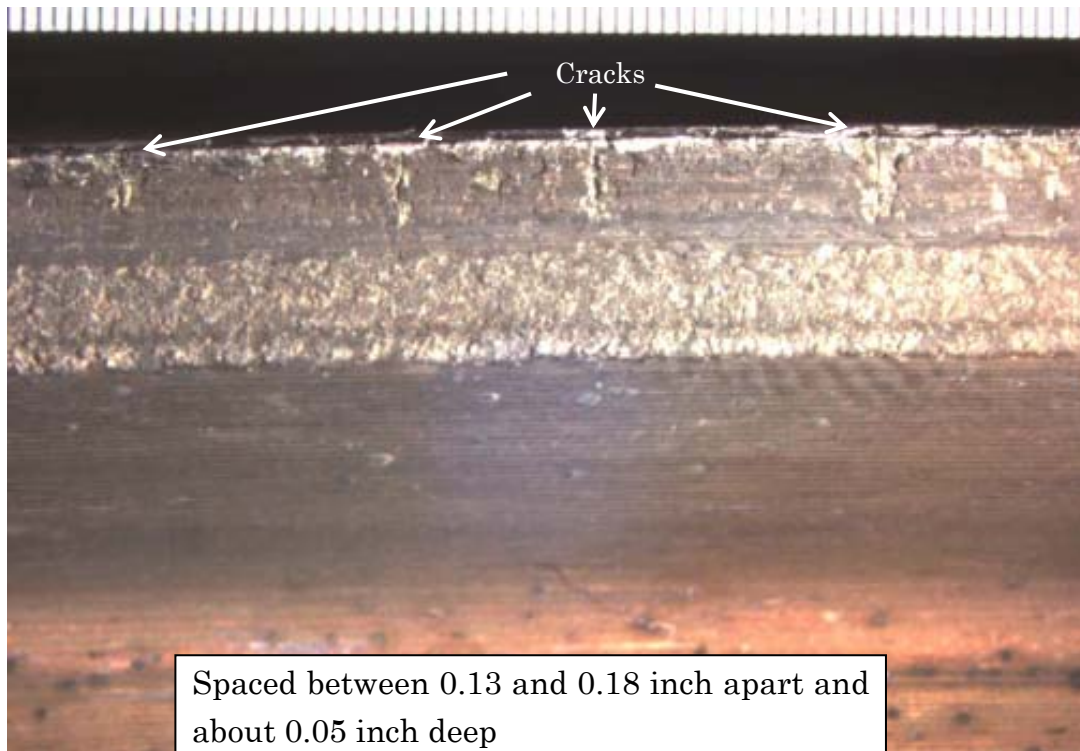

Photograph 10 Lenticular seal Tooth #4 Cracks

