

AA2013-4

**AIRCRAFT ACCIDENT  
INVESTIGATION REPORT**

**TOHO AIR SERVICE CO., LTD.**

**J A 5 0 8 A**

**April 26, 2013**



The objective of the investigation conducted by the Japan Transport Safety Board in accordance with the Act for Establishment of the Japan Transport Safety Board and with Annex 13 to the Convention on International Civil Aviation is to determine the causes of an accident and damage incidental to such an accident, thereby preventing future accidents and reducing damage. It is not the purpose of the investigation to apportion blame or liability.

Norihiro Goto  
Chairman,  
Japan Transport Safety Board

Note:

This report is a translation of the Japanese original investigation report. The text in Japanese shall prevail in the interpretation of the report.

# AIRCRAFT ACCIDENT INVESTIGATION REPORT

UNCONTROLLED CRASH INTO THE GROUND

TOHO AIR SERVICE CO., LTD.

EUROCOPTER AS350 B3, JA508A

KIYOKAWA VILLAGE, AIKO-GUN, KANAGAWA PREFECTURE, JAPAN

APPROXIMATELY 12:17 JST, OCTOBER 3, 2011

March 22, 2013

Adopted by the Japan Transport Safety Board

Chairman	Norihiro Goto
Member	Shinsuke Endoh
Member	Toshiyuki Ishikawa
Member	Sadao Tamura
Member	Yuki Shuto
Member	Keiji Tanaka

## SYNOPSIS

### < Summary of the Accident >

On October 3 (Monday), 2011, a Eurocopter AS350 B3, registered JA508A, operated by Toho Air Service Co., Ltd. took off from the Karasawa temporary helipad in Kiyokawa Village, Aiko-gun, Kanagawa Prefecture to transport cargoes and sustained damage to its airframe during the flight. At approximately 12:17 Japan Standard Time (JST: UTC + 9 hrs, all times are indicated in JST on a 24-hour clock), the helicopter crashed into the Choja-yashiki Campground.

Two people in total were onboard the helicopter: a pilot in command (hereinafter referred to as “the Pilot”) and an onboard mechanic. The Pilot was killed and the onboard mechanic was seriously injured.

The helicopter was destroyed and a fire broke out.

### < Probable Causes >

It is probable that the accident occurred as follows: The helicopter sling cable contacted the tail rotor, damaging the tail section and resulting in a loss of tail rotor thrust. The Pilot, however, did not make an emergency landing as soon as possible as stipulated in the Japanese Flight Manual, but instead continued to search for a suitable emergency landing site, during which time the damage to the tail section, including the vertical stabilizer, was exacerbated leading to its rupture, and the helicopter became uncontrollable and crashed into the ground.

It is possible that the sling cable contacted the tail rotor because the Pilot increased the airspeed excessively without carefully monitoring the movement of the sling cable with a rearview mirror; because when the Pilot adjusted the flight route downward, the load factor decreased, causing the distance between the end of the sling cable and the tail section to decrease; and because the movement of the end of the sling cable became unstable due to insufficient ballast weight.

It is probable that the Pilot failed to make an emergency landing as soon as possible as stipulated in the Japanese Flight Manual because he had not selected appropriate emergency landing sites before flight and was not prepared for emergency, including which landing site to choose in a given situation; and because the Pilot continued flying without anticipating the possibility that the damage to the helicopter could worsen making the helicopter uncontrollable.

# **1. PROCESS AND PROGRESS OF THE AIRCRAFT ACCIDENT INVESTIGATION**

## **1.1 Summary of the Accident**

On October 3 (Monday), 2011, a Eurocopter AS350 B3, registered JA508A, operated by Toho Air Service Co., Ltd. took off from the Karasawa temporary helipad in Kiyokawa Village, Aiko-gun, Kanagawa Prefecture to transport cargoes and sustained damage to its airframe during the flight. At around 12:17 Japan Standard Time (JST: UTC + 9 hrs, all times are indicated in JST on a 24-hour clock), the helicopter crashed into the Choja-yashiki Campground.

Two people in total were onboard the helicopter: the Pilot and an onboard mechanic. The Pilot was killed and the onboard mechanic was seriously injured.

The helicopter was destroyed and a fire broke out.

## **1.2 Outline of the Accident Investigation**

### **1.2.1 Investigation Organization**

On October 3, 2011, the Japan Transport Safety Board designated an investigator-in-charge and an investigator to investigate this accident.

### **1.2.2 Representatives of the Relevant State**

An accredited representative of France participated in the investigation as the State of Design and Manufacture of the helicopter involved in this accident.

### **1.2.3 Implementation of the Investigation**

October 3 to 5, 2011: On-site investigation, aircraft examination, and interviews

October 7, 2011: Documents investigation and interviews

October 21, 2011: Interviews

October 25, 2011: Aircraft examination

### **1.2.4 Comments from Parties Relevant to the Cause of the Accident**

Comments were invited from the parties relevant to the cause of the accident.

### **1.2.5 Comments from the Relevant State**

Comments on the draft report were invited from the relevant State.

## 2. FACTUAL INFORMATION

### 2.1 History of the Flight

On October 3, 2011 at approximately 09:30, a Eurocopter AS350 B3, registered JA508A (hereinafter referred to as "the Helicopter"), operated by Toho Air Service Co., Ltd. (hereinafter referred to as "the Company") took off from the Karasawa temporary helipad in Kiyokawa Village, Aiko-gun, Kanagawa Prefecture (530 meters above sea level; hereinafter referred to as "the Karasawa helipad") with the Pilot and an onboard mechanic to transport cargoes to be used for construction of a mountain trail. The flight history of the Helicopter up to the time of the accident is summarized below, according to the statements by the onboard mechanic, workers on the ground, on-site workers, and an witness.

#### a. Onboard mechanic

The onboard mechanic conducted a pre-flight check of the Helicopter at the Company's hanger at Chofu Airport to make sure that there were no abnormalities, and then moved it to the apron. At around 08:30, the Helicopter took off with four people in total on board; the Pilot, the onboard mechanic and two Company ground operators. At around 08:50, the Helicopter landed at the Karasawa helipad.

Before transporting cargoes, the Pilot had a meeting with those involved in the construction to map the locations of unloading sites No. 1 to No. 6 (hereinafter referred to in the text and in Figure 1 simply as "No.1" to "No. 6"), which are situated along the mountain ridge, to confirm the number of times transport was required, and to discuss other details. At around 09:20, the Pilot, who occupied the front right seat, took off on a flight for about ten minutes to observe and check these sites along with the onboard mechanic, who was in the back left seat, and the person who ordered the construction work (hereinafter referred to as "the Customer"), who was in the front left seat. During the flight, they were not able to approach close to No.6 due to the presence of gas<sup>\*1</sup>.

The Helicopter returned to the Karasawa helipad to disembark the Orderer and to attach a 27-meter sling cable to be used for unloading cargoes among tall trees. The Pilot then began transporting cargoes to sites within flight range. After flying to and from the sites a number of times, upon returning to the Karasawa helipad, the onboard mechanic observed the sling cable flying in the wind in the direction of the posterior end of the fuselage (around the tail guard) in the rearview mirror on the left (hereinafter referred to as "the mirror"). The onboard mechanic reported the observation to the Pilot, to which the Pilot replied, "I'll be careful." Before later heading to No. 6, they replaced the 27-meter sling cable with a seven-meter sling cable, which is used in areas where no tall trees or other tall obstacles are present. Although they set out for the site carrying external cargo with the seven-meter sling cable beneath the Helicopter, they were not able to approach close to the site due to the presence of

---

<sup>\*1</sup> The term "gas" here collectively means cloud, mist and other gaseous phenomena, which cause a visibility hindrance.

gas and returned with the cargo. After replacing the seven meter sling cable with a 27-meter sling cable once again, they continued with transporting cargoes for some time. They then landed at the Karasawa helipad for refueling.

After refueling, the Pilot resumed cargo transportation. The Pilot flew to No. 6 and found that conditions had sufficiently recovered to allow the unloading of cargoes. He returned to the Karasawa helipad and replaced the 27 meter sling cable once again with the seven-meter sling cable. After transporting and unloading cargo at No. 6, the Pilot turned the Helicopter around and began his descent toward the Karasawa helipad.

During the return trip, somewhere around halfway to the Karasawa helipad, the onboard mechanic heard a loud “Bang” sound. Immediately thereafter, the Pilot said, “I think something hit the back.” The onboard mechanic stuck his head out of the left window to see behind the Helicopter and found that the tail rotor of the Helicopter (hereinafter referred to as “the TR”) had stopped rotating, the upper blade was broken and inside resin and other materials were exposed, and the tail lamp was coming off from the airframe and hanging from the tip of an electric wire. The onboard mechanic reported the situation to the Pilot. While circling, the Pilot contacted with a ground operator to inform that he would search for a wide area where he could land.

At the time the loud bang was heard from the back, sufficient distance between the Helicopter and the ground existed to avoid hitting any object on the ground. The Helicopter was flying stably and no turbulent flow was noticed.

When the onboard mechanic proposed a helipad at Ogouchi Dam, the Pilot began to turn the Helicopter to the north. Upon coming closer to the temporary helipad in Arai at the west end of Lake Miyagase (hereinafter referred to as “the Arai helipad”), the Pilot remarked “It’s too small.” The onboard mechanic thought that the Pilot might have been confused and indicated to him that that was not Ogouchi Dam. The Pilot then said, “Ogouchi Dam is still too far away,” and passed over the Arai helipad. While turning the Helicopter to the right, he then started to ascend.

The Pilot later received information from a ground operator that there was a disaster prevention heliport in Kiyokawa Village (hereinafter referred to as “the Kiyokawa heliport”) where the Helicopter could land. The Pilot asked the onboard mechanic to locate the heliport on a map and then began circling over an area away from the lake. The onboard mechanic looked for the location of the heliport on the map. When he found it and was about to tell the Pilot the location, the Helicopter was flying at an altitude higher than that of the mountains in the vicinity. At that time, the Helicopter had already started to yaw to the left when the Pilot then exclaimed, “We’re going to crash!” The initial yawing was horizontal but it gradually lowered its nose and crashed into the trees at the Choja-yashiki Campground (hereinafter after referred to as “the Campground”). Immediately before the crash, the airspeed seemed to be somewhat reduced.

The onboard mechanic struggled to release his seat belt, which was pressing deeply into his abdomen. When he found fuel leaking from the Helicopter, he immediately exited from the left side. He called to the Pilot before leaving the

Helicopter, but there was no response. After crossing the field ahead of him to get away from the Helicopter, the onboard mechanic then saw that the Helicopter was on fire. He climbed a slope at the entrance to the Campground and upon reaching a road, called for help to a passerby who then called for an ambulance.

b. Ground operators (two)

At around 09:35, the ground operators attached a 27-meter sling cable to the Helicopter and began their work according to the preliminary survey results. It took about six to seven minutes for a round trip to each unloading site.

They stopped their work several times due to the presence of gas. At around 10:30, a ground operator reported to the Pilot that he had been informed by an on-site worker that the weather had improved. After unloading cargo at No. 5, the Pilot flew to No. 6 to confirm the weather there. The Pilot then reported to the ground operator that the conditions were sufficient to allow transport of cargoes. When the Helicopter returned, the ground operators replaced the sling cable in use with a seven-meter sling cable. The Pilot headed for No. 6 carrying an external load beneath the Helicopter with the sling cable; however, due to bad weather, he returned to the helipad without unloading the cargo. The seven-meter sling cable was replaced with the 27-meter sling cable once again and transportation resumed. After completion of unloading at No. 2 through No. 5, 200 liters of fuel was fed into the Helicopter.

At around 11:50, the work resumed. After transporting cargoes to No.1, the Pilot continued flying to the area near No. 6 to check on the local weather. He then determined that it was possible to unload cargo there. The Helicopter returned to the Karasawa helipad, where the 27-meter sling cable was once again replaced with the seven-meter sling cable. Just before 12:00, the Helicopter headed for No. 6 again with the cargo slung beneath it.

A while later, a ground operator was informed with radio from the Helicopter that something had hit the rear side of the Helicopter. When the ground operator looked toward the ridge of the mountain where No. 6 was located, the Helicopter was seen on the left side of the ridge (the location of No. 3 to No. 5). Despite the ground operator's advice to land the Helicopter, the Pilot responded that he would rather find a place wider than the Karasawa helipad on which to land. As the Helicopter turned around to the left over an area on the southwest side of the Karasawa helipad, the ground operator received a radio message from the Pilot that they would head for Ogouchi Dam. The Helicopter flew to the north and visual contact was lost due to the shade of the mountains.

The Pilot subsequently reported that he would not fly to Ogouchi Dam and asked if it would be acceptable to land in the sports field that was below the Helicopter. In response, the ground operator provided information about the Kiyokawa heliport, which was received from the Orderer. The Pilot asked where the heliport was and the ground operator responded that it was next to a golf course located south of the Karasawa helipad. The ground operator also asked the Pilot to call him by phone upon landing there and the Pilot responded that he would. Following this, the ground operator lost contact with the Pilot.



The Helicopter was scheduled to transport and unload cargo at No. 6 three times over the rest of the morning, and at another site in the afternoon.

c. On-site Worker A

Before 10:00, on-site Worker A arrived at No. 6 and began working. Because No. 6 is located on high ground, he was able to see almost all of the site and its vicinity. Gas had occasionally flowed from the southwest to the northeast; however, there was no noticeable wind at that time.

The Helicopter flew to No. 6 from the south when the gas cleared. After unloading cargo from the hook, the Helicopter turned around and flew in the reverse course.

d. On-site Worker B

On-site Worker B, who was unpacking at No. 5, saw the Helicopter fly from No. 6 and pass over the southeast side of No. 5. From Worker B's perspective, the Helicopter was flying almost at eye-level. As the Helicopter passed beside him, he turned away from it. Immediately after this, he heard a large crack sound from the direction of where the Helicopter was, as though a tree had been broken. At that time, the sky was only partially cloudy.

e. Witness

The Witness was taking photos on a vacant lot (about 300 meters above sea level) near the southeast foot of a suspension bridge (for pedestrians) at Lake Miyagase. The Helicopter flew from the northwestern direction while turning to the right as if floating up from the ground. The Helicopter passed over near the bridge (Miyagase Yamabiko O-hash) and was heading for the Campground. It seemed to be flying normally.

He took two photos of the Helicopter: one was taken as it neared his location from the direction of the lake, and the other as it flew over an area near the bridge where a highway is situated. It was 12:13.

The accident occurred in Miyagase, Kiyokawa Village, Aiko-gun, Kanagawa Prefecture (35° 29' 51" N, 139 ° 13' 34" E) at around 12:17 (the time when the clock in the Helicopter had stopped and the time when the emergency signal was received from the emergency locator transmitter).

(See Figure 1 "Estimated Flight Path" and Figure 2 "Accident Site.")

## 2.2 Injuries to Persons

The Pilot was killed (traumatic subarachnoid hemorrhage due to fractured skull) and the onboard mechanic was seriously injured from a fracture and other injuries.

## 2.3 Damage to the Helicopter

### 2.3.1 Extent of Damage

Destroyed

### 2.3.2 Damage to the Helicopter Components

- a. Airframe: Destroyed by fire
- b. Main rotor (hereinafter referred to as “the MR”): Broken and damaged by fire
- c. Engine: Damaged by fire
- d. Tail boom: Ruptured
- e. Tail: The tail boom was ruptured and detached at a fore section of the tail gearbox (hereinafter referred to as “the TGB”) mount, causing the TR and TGB to fall off.

## 2.4 Personnel Information

Pilot: Male, Age 47

Commercial pilot certificate (Rotorcraft) February 13, 1990

Type rating for single turbine engine (land) February 13, 1990

Class 1 aviation medical certificate

Validity March 28, 2012

Total flight time 5,131 hours (hrs) 51 minutes (min)

Flight time in the last 30 days 43 hrs 10 min

Flight time for cargo transportation in the last 30 days 30 hrs 02 min

Total flight time on the type of helicopter 1,308 hrs 19 min

Flight time in the last 30 days 0 hrs 00 min

## 2.5 Helicopter Information

### 2.5.1 Helicopter

Type Eurocopter AS350 B3

Serial number 4349

Date of manufacture October 26, 2007

Certificate of airworthiness Dai-Tou-23-292

Validity September 29, 2012

Category of airworthiness Rotorcraft, Normal N or Special Aircraft X

Total flight time 1,688 hrs 32 min

Flight time since last periodical check

(600-hour check on September 22, 2011) 3 hrs 35 min

(See Figure 3 “Three-Angle View of Eurocopter AS350 B3.”)

### 2.5.2 Weight and Balance

When the accident occurred, the Helicopter’s weight is estimated to have been 1,643 kg, and the position of the center of gravity (CG) is estimated to have been longitudinally 3.41 m aft of the reference plane (3.4 m ahead of the centerline of the MR head) and laterally 0.02 m to the left of the airframe symmetry plane, both of which are estimated to have been within the allowable range (the maximum gross weight of 2,800 kg, and the CG range for the Helicopter’s weight at the time of the accident: longitudinally 3.17 to 3.48 m aft of the reference plane and laterally 0.18 m to the left and 0.14 m to the right of the airframe symmetry plane).

(See Figure 3 “Three-Angle View of Eurocopter AS350 B3.”)

## **2.6 Meteorological Information**

According to On-site Workers A and B, when the Helicopter was transporting cargoes to No.6, the sky was only partially cloudy and there was no noticeable wind. Additionally, gas occasionally flowed from the southwest.

According to the onboard mechanic, the airflow was stable during the flight and no turbulent flow that could affect the Helicopter was felt.

## **2.7 Accident Site and Wreckage Information**

### **2.7.1 Information concerning the Accident Site and its Surroundings**

The Campground is located in the Tanzawa Mountains, about 3 kilometers from one of the valleys lying to the south of Lake Miyagase. The valley also connects to the Karasawa helipad and leads to the back end of Shin-Dainichi-dake (unloading site No. 6). On the western side of the accident site is an 844-meter peak, with ridges connected to the Tanzawa Mountains on the western side. There is also an 817-meter peak to the south, while peaks in other directions are lower.

In the park by Lake Miyagase is an open grassy space larger than 100 meter square. Also, downstream of Miyagase Dam is a riverbed, a sports field, farmland, and other lots that are also larger than 100 meter square. In addition, near an intersection of a road heading from the lakeside to the Campground, there is an approximately 100 meter square vacant lot that is sometimes used as a temporary parking lot.

The Campground is situated about 15 meters lower than the public road and is about 300 meters above sea level. Facilities situated among the trees around the open space were temporarily used as a parking lot.

The Helicopter crashed beside these facilities into the trees on the southern side of the open space with its nose pointing to the west. Most of the airframe was destroyed by the fire that occurred after the crash but part of the instrument panel, engine, part of the MR, part of the main gearbox, and the front and rear cross tubes were spared by the fire. The tail boom had fallen to the ground to the east of the airframe wreckage, facing west; the fore section was ruptured near the junction with the airframe, the rear section was broken at the front of TBG mounting support. The nylon rope, which comprised part of the sling cable, had dropped on the tail boom and the end of it was melted and scorched into the cover of the TR drive shaft.

The tail section, including the vertical stabilizer, which was ruptured and detached from the tail boom, was found about five meters northwest of the fuselage. However, the TR and TGB, for which the connecting parts to the airframe had broken and fallen off, were not found at the crash site or the surrounding area.

The Campground facilities near the crashed airframe were destroyed or damaged by spreading flames and five or six trees had been severed about 15 meters height above the ground.

(See Figure 1 “Estimated Flight Path” and Figure 2 “Accident Site”)

### **2.7.2 Details on the Extent of Damage**

#### **a. Fuselage**

Fire destroyed the case of the main gear box, exposing the gears. The front and rear cross tubes were found upside down. The instrument panel was also found upside down, with half of it buried in the ground. It had been scorched by fire and was found on the western side of the burned and destroyed fuselage. The cargo hook was damaged by fire and the sensor portion of load meter and the hook were separated.

b. MR

Half of the exterior of all three MR blades were broken and scorched. The rotor head was damaged by fire but remained connected to the MR blades.

c. Engine

The exterior of the engine was damaged and the rotating shaft was confined.

In addition, the leading edges of whole blades of fore stage compressor were fractured.

d. Tail boom

The tail boom was broken at an immediately fore part of the flange that was connected to the fuselage, and was damaged by fire. The tail boom was also broken at an immediately fore part of the bracket that supports the front part of the TGB (near the flexible coupling) and had separated from the back part of the tail.

On the upper side of the ruptured surface that had detached from the tail, continuous dents were seen from the upper left to the upper right of the area where the angle was attached, which resulted from being hit by the protruding portion of the flexible coupling while it was rotating. In addition, there were ruptures beginning from the left and right ends of the cutting section where the dents described above were found, as though the surface had been torn apart. The rupture on the right developed diagonally to the front, and continued up to near the section where the outer shell was overlaid, about 20 cm ahead of the upper cutting surface and on the lower left. The rupture on the left initially developed diagonally downward and then in a forward direction. It continued up to about 8 cm ahead of the end of the rupture on the right, where it fell apart towards the left as though it had been torn off.

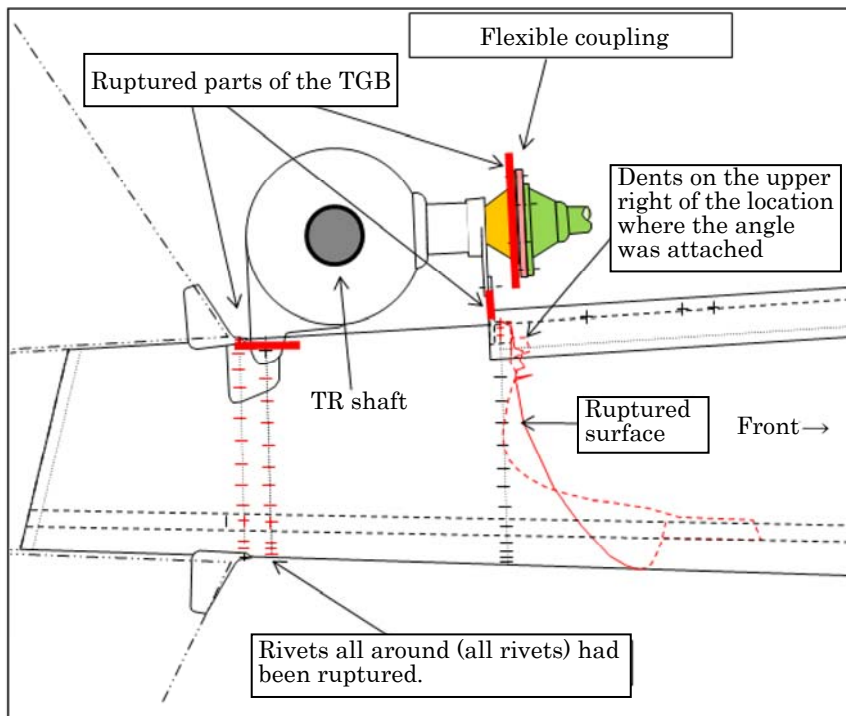

(Ruptured Tail Boom)

The TR drive shaft had detached at the flexible coupling section and there were many circumferential scratches on the external side of six protruding parts of the flexible coupling.

The tail guard was bent downward at an immediately fore position of the section to which the lower end of the vertical stabilizer had been attached. Its surface was crushed vertically and had ruptured. In addition, there were wire contact marks 15 to 25 cm and 30 to 45 cm from the front attaching portion.

(See photo of the Helicopter taken by the Witness (enlarged photo of the tail section) (p.11) and attached Photos of the Helicopter Involved in the Accident(Ruptured Surface of Tail Boom and Tail Guard).)

e. Tail section

A rupture on the outer shell on the right side of the lower vertical stabilizer had occurred when the tip of a revolving TR blade had become stuck in it. On the trailing edge of each of the upper and lower vertical stabilizers, a number of marks were seen on parts that had hit trees and had become deformed. No marks made by trees were seen on the sides of the stabilizers.

The support brackets for the fuselage at the attachment section of the front part of the TGB had dropped off along with the TGB. Of the two anchor bolts on the right and left of the attachment section of the rear part of the TGB, the left one had been pulled out towards the right and had dropped off, while the one on the right remained in such a way that it stabilized a broken piece of the ruptured TGB housing.

f. Sling cables

The seven-meter sling cable was made by connecting a two-meter nylon rope (32 mm in diameter) at the upper end to a 10-meter steel wire (12 mm in

diameter) that was folded in two, giving it a total length of five meters. A steel ring and a shackle (metal fitting for connection purposes) were present at the upper end, and a shackle and a small hook in the middle. At the lower end, a hook for lifting cargo about 40 cm in length and weighing about 5.7 kg was attached via a steel ring and a swivel. At the junction of the hook, a piece of white cloth was knotted around as a sign. The sling cable's total length was about eight meters and the total weight was about 15.5 kg. (The 27-meter sling cable was made by connecting three 10-meter steel wires – two folded in half and the remaining one unfolded – between the nylon rope and the steel wire of the seven-meter sling cable using a shackle and a steel ring. The total length was about 28 meters and the total weight was about 35 kg.)

The seven-meter sling cable found at the accident site had been damaged by fire after detaching from the hook of the airframe and falling on the tail boom, with the exception of about 70 cm of the two-meter nylon rope on the upper end. The steel wire was deformed at around 90 cm and around 130 cm from the lower end, as though it had been bent, and the strand had partially been cut off.

(See Figure 4 “Seven-meter Sling Cable.”)

### **2.7.3 Other Damage**

Of the facilities present in the Campground, four were destroyed by fire, one was partially damaged by fire and 38 trees were damaged (including trees damaged by fire).

## **2.8 Flight Condition from Photos Taken Before the Crash**

As described in 2.1 e., two photos of the Helicopter flying over near Lake Miyagase had been taken about four minutes before the crash, which showed the following conditions:

- ① The TR blades had stopped turning. The upper blade was broken at about half the length of the wing and material that appeared to be fiber was fluttering in the wind from the upper end. The lower end of the bottom blade had dug into the lower vertical stabilizer.
- ② The cover of the TGB was cut near the flexible coupling.
- ③ The TR shaft had tilted backward.
- ④ The tail lamp had come off, and was hanging from the tip of an electric wire.
- ⑤ The seven-meter sling cable that was suspended from the Helicopter was fluttering backward in the wind at an angle of about 50°. The steel wire part had been bent backward and the section near the lower end had drooped slightly downward due to the weight of the hook. A portion about one meter from the lower end had twisted abnormally. (This is where the bend and the strand that was cut off were observed in the wreckage investigation.)

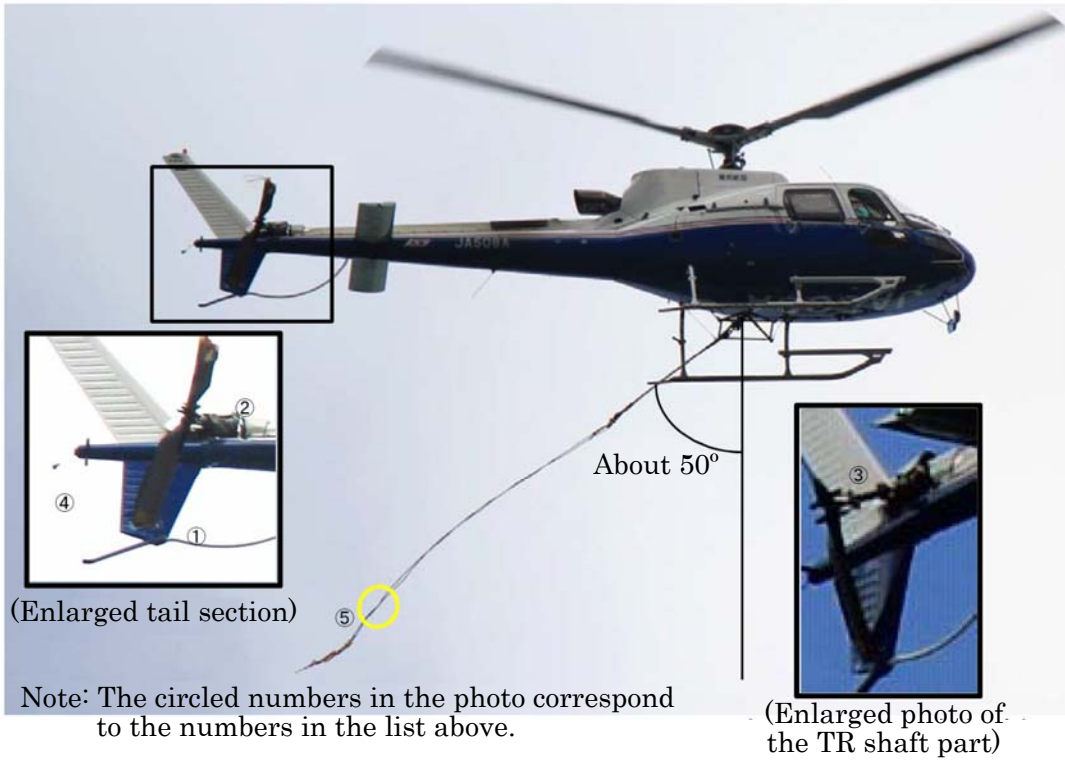

(Photos of the Helicopter taken by the Witness)

## 2.9 Training and Qualifications of the Pilot

### 2.9.1 In-house Qualifications Issued to the Pilot

The Company provided the Pilot with training according to its operations manual.

The Pilot had obtained experience at another company. After joining the Company in February 2003, the Pilot received promotion training for AS355 pilots and underwent an assessment, and was appointed as an AS355 transport pilot on March 4, 2003. Subsequently, until March 1, 2010, the Pilot had received training and qualification assessments for a number of different types of helicopter and had been appointed as a transport pilot with the AS350, SA365 and SA315, and as an aerial work pilot with the EC135.

Regarding cargo transportation, the Pilot received training mainly with the SA315 in the period from March 21, 2009 to May 29, 2010, followed by an assessment on June 3, 2010. On June 5, 2010, the Pilot was appointed as a cargo transportation pilot. While the standard time required for this training is 40 hours, due to a number of interruptions as the Pilot was receiving his training (with the longest interruption period being about five months), the total flight training time received amounted to 108 hours and 20 minutes during the period indicated above. On November 4 and 5, 2010, the Pilot completed cargo transportation training with the AS350 and began engaging in cargo transportation with this type of Helicopter.

### 2.9.2 Training for Preparation for TR Failure

On two occasions the Company provided the Pilot with the following training in order to prepare for TR failures. The Pilot did not receive any training with the same type of helicopter that was involved in the accident. The training did not include that of autorotation\*<sup>2</sup> based on the assumption of a loss of TR power.

Date	Type	Training
September 26, 2003	EC135	In training with a new type of helicopter, on the assumption of a loss of TR control, flights were conducted several times with the ladder pedal fixed at about neutral to approach directly facing the runway and adjust the axis line.
January 11, 2006	SA365	On the assumption of a loss of TR control, a flight was conducted with the ladder pedal fixed at about neutral to approach and land on a runway.

### 2.9.3 Training for Autorotation

Training for autorotation based on the assumption of an engine failure of the same type that occurred with the Helicopter involved in the accident was provided to the Pilot in the periodic training and periodic assessment on March 4, 2011.

---

<sup>2</sup> "Autorotation" is a flight condition where the main rotor blades are driven by the force of the relative wind passing through the blades while descending, rather than by the engine. When landing in autorotation, it is not possible to adjust the final approach path using the engine. For this reason, errors may occur regarding the landing site. If setting an emergency landing site beforehand, you need to take into account possible errors, obstacles in the vicinity and other factors in determining the width of the site.



## 2.10 Information on How to Operate the Helicopter

### 2.10.1 Japanese Flight Manual Section 3, Emergency Procedures, (excerpts)

#### *Section 3 Emergency Procedures*

##### *3.1 GENERAL*

*To help the pilot in his decision process, four recommendations are used:*

- *LAND IMMEDIATELY*            *Self explanatory.*
- *LAND AS SOON AS POSSIBLE*        *Emergency conditions are urgent and require landing at the nearest landing site at which a safe landing can be made.*
- *LAND AS SOON AS PRACTICABLE*        *Emergency conditions are less urgent and in the pilot's judgment, he may proceed to the nearest airfield where he can expect appropriate assistance.*
- *CONTINUE FLIGHT*            *Continue flight as planned. (Omitted)*

##### *3.2 ENGINE FLAME-OUT*

###### *3.2.1 CRUISE FLIGHT*

###### *AUTOROTATION PROCEDURE OVER LAND*

1. *Collective Pitch Lever ..... REDUCE to maintain NR<sup>\*3</sup> in green arc.*
2. *IAS ..... V<sub>y</sub><sup>\*4</sup>*
  - *If relighting impossible or after tail rotor failure*
3. *Twist grip ..... IDLE detent<sup>\*5</sup>*
4. *Maneuver a helicopter into the wind on final approach.*
  - *At height 70 ft (21 m)*
5. *Cyclic Stick..... FLARE*
  - *At 20 – 25 ft (6 – 8 m) and at constant attitude*
6. *Collective Pitch Lever..... GRADUALLY INCREASE to reduce the rate of descent and forward speed.*
7. *Cyclic Stick..... FORWARD to adopt a slightly nose-up landing attitude (< 10°).*
8. *Yaw Control Pedal ..... ADJUST to cancel any sideslip tendency.*
9. *Collective Pitch Lever ..... INCREASE to cushion touch-down.*  
(Omitted)

##### *3.3 TAIL ROTOR FAILURES*

###### *3.3.1 COMPLETE LOSS OF TAIL ROTOR EFFECTIVENESS*

*Symptom: the helicopter will yaw to the left with a rotational speed depending on the amount of power and the forward speed set at the time of the failure.*

(Omitted)

###### *3.3.1.3 IN CRUISE FLIGHT*

1. *Cyclic Stick..... ADJUST to set IAS to V<sub>y</sub> and control yaw*
2. *Collective Pitch Lever..... REDUCE to avoid sideslip*

---

<sup>3</sup> "NR" is the number of revolutions of the MR.

<sup>4</sup> "V<sub>y</sub>" is the best rate-of-climb speed. In the case of this helicopter, the airspeed at an altitude of 0 ft is 65 kt and, a – 1 kt for every 1000 ft increase in altitude. This will be the speed close to that at which the minimum horse power is required to maintain flight.

<sup>5</sup> "Idle detent" is a position where the engine output will not increase any higher than the idling speed even when CP increases.

*LAND AS SOON AS POSSIBLE.*

*APPROACH AND LANDING*

*On a suitable area for autorotative landing:*

- 1. Twist grip ..... IDLE detent*
- 2. Carry out an autorotative landing as landing procedure.*

(Omitted)

**2.10.2 Flight Manual Supplement 9-13.2 “External Load Transport ‘Cargo Swing’ 1,400 kg (3,086 lbs) With ‘On-Board’ Fixed Release Unit” Section 2 Limitations and Section 4 Normal Procedures (excerpts)**

*2.3 AIRSPEED LIMITATION*

*Absolute maximum permissible speed with external load ..... 80 kt (148 km/h)*

*Note*

*The pilot is responsible for determining the limit speed according to the load and sling length. Particular care must be exercised when bulky loads are carried on the sling.*

(Omitted)

*Section 4 NORMAL PROCEDURES*

(Omitted)

- The length of the sling cable must be determined in accordance with the type of the mission. To carry a compact load, it is recommended to use the shortest possible cable.*

*Caution*

*Flying with a cable with no load attached or with an empty net slung beneath a helicopter is prohibited.*

(The description in the English Manual: FMS 9-13.2/4. *Normal procedure, Caution “Flying with an un-ballasted sling cable or empty net is prohibited.”*)

*4.3 MANEUVERS*

*All control movements should be made very gently, with very gradual acceleration and deceleration, and only slightly banked turns.*

(Omitted)

**2.10.3 The Company Manual TSOP 2-2-001 “Air Cargo Transport Procedures (Operation)” (Revised on January 31, 2010) (excerpts)**

TSOP 2-2-001 “Air Cargo Transport Procedures (Operation)” is the Company’s Manual defining the standard procedures for cargo transportation. Some parts of the Manual, including how to operate helicopter, were borrowed from the Japanese Flight Manual.

*1. General*

*1-2 What Cargo Transport Pilots Should Keep in Mind*

- (2) Cargo transport operations tend to be affected by environmental factors such as geographical and climate conditions. Therefore, a preliminary survey of the area where cargo is to be transported must be thoroughly conducted before making a flight plan.*

(Omitted)

- (3) A cargo transport operation is a continuous single flight operation and therefore may tend to be conducted mechanically. The pilot must be careful to not operate the helicopter in a careless and reckless manner.*

(Omitted)

*3. Procedures for Flight Operations*

### *3-12 Return Flights*

*(1) On return flights, pilots tend to operate helicopter in a careless and reckless manner as a result of feeling relief after unloading their cargoes. The presence of a double hook, an empty cargo net, a pallet sling, and/or other tools hanging from the helicopter may be overlooked by the pilot, which could lead to an unexpected accident. Therefore, pilots must always pay attention to anything that is carried beneath the helicopter while flying.*

*(Omitted)*

*(3) Checking rearview mirrors (paying careful attention to the double hook, cargo net, or pallet sling)*

*(4) Consideration of an emergency landing site*

*(5) Airspeed must be appropriately controlled even when no load is carried (e.g., a double hook, cargo net, or a pallet sling) so as not to exceed the airspeed limit defined by the helicopter Operations Manual. The pilot must not conduct an autorotative descent to adjust the altitude. When approaching a helipad, the pilot must not conduct a flaring maneuver directly over or within close range of the helipad.*

*(Omitted)*

### *5. Emergency Operations*

*(1) Emergency landing sites and flight routes*

*It is most important to select an emergency landing site on the flight route for cargo transportation. In many cases, however, work sites are in rugged mountainous areas. Pilots should take into account both economic efficiency and safety when setting a flight route. Even if a selected site for an emergency landing may not be the most satisfactory, as long as it is under relatively favorable conditions, it should be accepted because almost no sites are perfect for an emergency landing in mountain areas.*

*- A site for an emergency landing should be selected during a survey flight prior to starting the work.*

*- The flight route should be planned with the selected emergency landing site taken into consideration.*

*- The determined flight route should not be changed without good reason.*

*(2) An emergency*

*When an emergency occurs, whether or not a cargo load should be cut loose depends on what its contents are, although as a general rule, it should indeed be cut. The ultimate decision depends on the extent of the trouble with the helicopter or the part that should be cut loose.*

### **2.10.4 Service Letter from the Helicopter's Design and Manufacturing Company**

Information on sling work was provided by the helicopter's design and manufacturing company in its Service Letter (No. 1727-25-05: 30.03.2006) (hereinafter referred to as "the SL") but was only filed by the Maintenance Department of the Company and was not shared with the Flight Operations Department.

"SUBJECT: EQUIPMENT AND FURNISHINGS: Sling work" (excerpt)

*The purpose of this Service-Letter is not to instruct pilots in sling load operations, but to remind them of some lessons learned from analysis of accidents. EUROCOPTER is not admitting the existence of any duty and/or any liability concerning these accidents, but wishes that observance of the lessons learned leads to a decrease in the risks.*

*Lessons Learned*

(Omitted)

*Unloaded sling cables, especially, short sling cables (5 to 10m), should be ballasted with at least 15kg at cargo hook.*

(Omitted)

*With unloaded sling cables, avoid descending at airspeeds above  $V_y$ , and avoid load factors less than 0.5 g.*

(Omitted)

*3) Solutions*

*Ballast slings, especially those that are less than 10m long. The effect is obvious in stabilized flight. During descents at airspeed above  $V_y$ , it is possible for the sling cable to move upward, even with ballast, at load factors less than 0.5 g. This phenomenon can be avoided by conducting descents at airspeeds below  $V_y$ .*

**REMARK:**

*In the event of tail rotor contact and loss of control consider the following procedure.*

*Depending on weight, damage, altitude and airspeed, the suggested procedure will be more or less effective, but may provide the best alternative for this circumstance.*

*The helicopter will start a quick leftward rotation (rotor rotating clockwise), and even if the pilot did not respond early enough, and the helicopter has already rotated several turns, proceed as follows:*

- Select full low pitch.*
- Shut down the engine completely*
- If possible, establish a speed of 40 kt as soon as the helicopter stops rotating. In case of a loss of the tail fin, the descent will be vertical.*
- Down to a height of approx. 200 m above the ground, the situation seems to have become normal, then the sensation of vertical speed will become more and more obvious.*
- Start increasing the pitch at a height that is twice the usual height for an autorotation. The touchdown will be hard, but survivable.*

*(High-energy absorbing seats increase the survivability considerably). (Omitted)*

## 2.11 Additional Information

### 2.11.1 Topographic Features in the Vicinity of the Cargo Unloading Site

No. 1 through No. 3 can be viewed from the Karasawa helipad but other sites cannot since No. 4 and No.5 are hidden behind No. 3, and No. 6 is hidden behind the high point of the ridge running from No. 5 to No.6.

The altitudes of the accident site, the Arai helipad, the Karasawa helipad and No.1 through No.6 are as follows:

Site	Accident site	Arai helipad	Karasawa helipad	No. 1	No. 2	No. 3	No. 4	No. 5	No. 6
Altitude (m)	About 300	About 300	About 530	About 730	About 720	About 880	About 1,000	About 1,060	About 1,340

### 2.11.2 Characteristics of Sling Work

An interview survey on the characteristics of the seven-meter and the 27-meter slings used by the Company, particularly during their use in operation, and other relevant issues was conducted with instructor pilots and other Company staff. The following is a summary of the results:

The survey responders did not understand that the sling correspond to cables that do not carry a load described in the “Caution” section under “Normal Procedures” in the Japanese Flight Manual because a hook is present at the end of the wire cable of the sling and the weight of the hook acts as a ballast even after unloading. At the time the accident occurred, none of the survey responders acknowledged that the recommended weight for the ballast for the SL is 15 kg or more.

Even with the conventional operation method, the 27-meter sling cable, which possesses four steel wires, is stable beneath the helicopter even after unloading because the end hangs down with the weight of the wires and the hook, which can be monitored using the mirrors during flight. The seven-meter sling cable tends to more easily move toward the tail section compared with the 27-meter sling cable when a disturbance or other adverse weather condition occurs because the end of the sling cable becomes unstable. However, if the pilot increases the airspeed gradually but still maintains the cruising speed at which a safe distance between the sling cable and the tail can be ensured while adjusting the angle of an electrically-operated mirror and carefully monitoring the change in the distance between them, then there will be no danger of the sling cable hitting the tail section.

### 2.11.3 Measures Taken by the Company in Line with the Safety Measures and Policies of the Civil Aviation Bureau of the Ministry of Land, Infrastructure, Transport and Tourism

#### a. Selection of training subjects for emergency procedures

In response to the Aircraft Accident Investigation Report (AA11-4-1) published by the Japan Transport Safety Board related to the crash of a helicopter due to a TR failure that occurred on December 9, 2007 in Shizuoka City in Shizuoka Prefecture, on April 22, 2011, the Civil Aviation Bureau (CAB) of the Ministry of Land, Infrastructure, Transport and Tourism (MLIT) issued a notification to All Japan Air Transport and Service Association Co., Ltd. (AJATS)

instructing the appropriate selection of training subjects for emergency procedures and other relevant issues. In response, on April 25, 2011 the Company provided in writing the information that was included in the notification throughout the organization. However, no changes were made to the subject training because training related to TR failures had already been included as one of the elective subjects in a periodic training program.

b. Awareness of safety and other information

In response to the Aircraft Accident Investigation Report (AA09-10-1) published by the Japan Transport Safety Board related to an emergency landing due to engine shutdown that occurred on August 19, 2008 in Yao City in Osaka Prefecture, on November 27, 2009, CAB issued a notification to AJATS. that instructed company-wide sharing of safety information provided by manufacturers and other sources and accurate communication of information on failures and defects within the company. This notification was circulated by the Company within the organization.

#### **2.11.4 Structure of the Tail Boom and Load Placed on It during Flight**

A tail boom consists of an aluminum plate rounded in such a way that the area on the side of the nose is thicker than the remaining area and overlaps on the lower left. The frame is attached to the section joined to the vertical stabilizer (front and rear spars), the section attached to the TGB (front and rear), the section attached to the horizontal stabilizer (front and rear of stiffeners) and the support for the TR drive shaft. A circular-shaped flange is attached at the foremost front area and bolted to the fuselage.

During a flight, the antitorque of the main rotor is balanced by the thrust of the TR and the aerodynamic force generated by the vertical stabilizer, meaning a leftward force is constantly applied to the tail section.

### **3. ANALYSIS**

#### **3.1 Qualification of Personnel**

The Pilot held both valid airman competence certificate and valid aviation medical certificate.

#### **3.2 Airworthiness Certificate of the Helicopter**

The Helicopter had a valid airworthiness certificate and had been maintained and inspected as prescribed.

#### **3.3 Effects of Meteorological Phenomena**

As described in 2.6, it is probable that the weather was fine, with only light winds at the time of the accident. According to the statements in 2.1 a., there was probably no turbulent flow that was large enough to make the airframe unstable. However, in the vicinity of No. 6, it is probable that the presence of gas occasionally resulted in temporarily difficulties unloading cargo.

#### **3.4 Events that Led the Helicopter to Crash**

##### **3.4.1 Situation of Cargo Transfer before the Accident**

According to the statements in 2.1 a., before the accident, during a return flight to the Karasawa helipad following unloading of the cargo, the onboard mechanic saw the 27-meter sling cable moving closer to the tail section of the Helicopter and had warned the Pilot, and, according to the onboard mechanic, the Pilot understood the situation.

As described in 2.10.4, it is probable that the aerodynamic force generated as airspeed increases and a decrease in load factor affect the upward movement of the sling cable. As load factor decreases, the Helicopter starts in a downward accelerated motion, but the sling cable does not immediately follow the Helicopter's movement due to inertial force. The sling cable therefore moves relatively upward. As described in 3.3, however, there was no turbulent flow at the time of the accident. Probably, therefore, very little change in the load factor was caused by airflow turbulence. For these reasons, it is probable that the 27-meter sling cable, which is considered to have higher stability than the seven-meter sling cable based on the description in 2.11.2, moved closer to the tail guard of the Helicopter likely as a result of the increased aerodynamic force caused by excessive airspeed.

It is also probable that the Pilot did not recognize the situation until the warning was given by the onboard mechanic and therefore had not appropriately monitored the sling cable with the mirror.

##### **3.4.2 Damage to the TR**

- a. As described in 2.10.4, the Company was provided with the following information in the SL: "Unloaded sling cables, especially short sling cables (5 to 10 m), should be ballasted with at least 15 kg at cargo hook." However, the information was not widely shared in the Flight Operations Department.

According to the statements in 2.1 a. and b., after transporting cargoes to No. 6, a seven-meter sling cable with a hook at the end weighing 5.7 kg as described in

2.7.2 f. but without any attached load, was attached to the Helicopter. This is much lighter than the 15 kg minimum required weight of the ballast as stipulated in the SL. It is highly probable therefore that the Helicopter's sling cable was not stable. For this reason, it is probable that the sling cable was prone to cause the "phenomenon of upward movement" which is described in the SL.

- b. According to the statement in 2.1 d., a large crack sound was heard from the Helicopter; besides, based on details of the extent of the damage in 2.7.2, the photos of the Helicopter taken by the Witness in 2.8, and the situation described in a. above, it is probable that the Helicopter sling cable contacted the TR at the time when this sound was heard. Immediately prior to this sound, the Helicopter was seen flying at the same altitude as that of No. 5. At that time, the direct distance between No. 6 and No. 5 was about 1,830 meters. Based on the altitudes shown in 2.11.1, the difference of elevation between No. 6 and No. 5 is about 280 meters and the angle of inclination is about 8.7°. The direct distance between No. 5 and the Karasawa helipad is about 2,970 meters, the difference of elevation about 530 m, and the angle of inclination about 10.1°. When flying from No.6 to No. 5, the Pilot took a route around the southwestern side of the highest point of the mountain ridge, which is 300 meters longer than the direct distance between the two points. Taking this into account, the average path angle of the flight route from No. 6 to No. 5 is thought to have been about 7.5°. Considering all of the above, around the time the Helicopter passed over the vicinity of the southeastern side of No. 5, it is possible that the load factor on the Helicopter decreased when the Pilot adjusted the path downward (about 10°) to change the destination to the Karasawa helipad.
- c. As described in 3.3, gas occasionally flows into No. 6, causing occasional brief difficulties in unloading cargo. It is therefore possible that when returning after completing the first cargo unloading at No. 6 with the seven-meter sling cable, the Pilot increased the airspeed to accelerate the pace of work considering the remaining work to be done.

Judging from the descriptions in 2.10.4 and 2.11.2, it is probable that the stability of the end of the seven-meter sling cable based on the airspeed was considerably poorer than that of the 27-meter sling cable that had been used by the Pilot during the previous transportation run.

It is probable that the possible reasons for the contact of the sling cable with the TR are: around the time when the Helicopter was passing over No.5 under the circumstances described above, the Pilot increased the airspeed excessively without carefully monitoring the movement of the sling cable with the mirror; when the Pilot adjusted the flight route downward, the load factor decreased, causing the distance between the end of the sling cable and the tail section to decrease; and the movement of the end of the sling cable became unstable due to insufficient ballast weight. It is possible that, because the Helicopter's load factor had decreased, meaning that lift had decreased, the Helicopter failed to maintain a balance with gravitational force, resulting in an accelerated downward motion. However, due to inertial force, the hook did not immediately follow the Helicopter's movement, and instead started moving relatively upward. Additionally, due to the



effect of the aerodynamic force caused by the excessive airspeed, it is possible that the sling cable, with its insufficient ballast weight, contacted the TR.

- d. According to the statement in 2.1 a., the Helicopter had been flying normally before the onboard mechanic heard a large crack sound coming from behind him; therefore, it is highly probable that there had been no problems with the Helicopter until that point in time.

Judging from the extent of the damage to the tail boom and the seven-meter sling cable as described in 2.7.2 d., e. and 2.8, it is highly probable that the section of the TR attached to the TGB was broken by the impact of the contact of the seven-meter sling cable with the TR causing the TR shaft (the output axis of the TGB) to tilt backward and, simultaneously, breaking the mount (the input axis of the TGB) with the flexible coupling of the TGB.

- e. It is probable that the TR drive shaft kept revolving with the flexible coupling after its detachment, so that the flexible coupling with no support swung wildly, with the protruding portion colliding with and damaging the surrounding structure and worsening the damage over time.
- f. According to the statement in 2.1 b., the Helicopter headed to No. 6 just before 12:00. Taking the flight distance, the unloading time and other factors into account, it is possible that the sling cable contacted the TR at around 12:05.

(See Figure 5 “Chain Reaction of Contributing Factors to the Accident.”)

### **3.4.3 Decision on an Emergency Landing**

According to the statement in 2.1 a., it is highly probable that the Pilot, being aware that the TR had stopped rotating, thought it necessary to find a wider space at which to make an emergency landing without the use of TR thrust, giving up the initial plan to land at the Karasawa helipad, and continued flying, searching for another suitable landing site. When the onboard mechanic proposed the use of a helipad at Ogouchi Dam, the Pilot turned the Helicopter to the north and gradually lowered the altitude. However, upon coming closer to the Arai helipad on the side of Lake Miyagase, he judged that it was too small to land there. According to the onboard mechanic, the Pilot also considered that Ogouchi Dam was too far and decided not to go there as well. It appears that upon receiving the proposal from the onboard mechanic, the Pilot believed that the Arai helipad, located immediately north of where he was flying, was the best choice rather than the helipad at Ogouchi Dam in Oku-tama and that, upon his approach to the Arai helipad, he found that it was too small. Following this, the Pilot then also appeared to judge that Ogouchi Dam was too far. It is probable that this hesitation of the Pilot caused his failure to quickly decide where to make an emergency landing.

As described in 2.10.3, according to the Company’s Manual, pilots are required to select emergency landing sites prior to starting the work. Therefore, the Pilot was required to select appropriate emergency landing sites within a distance short enough for the Helicopter to immediately reach from the flight route. While flying, pilots should always keep in mind emergency landing sites selected in advance and be prepared for an emergency, including which landing site to choose in a given situation. They need to be well-prepared so as to be able to decide where to make an emergency landing. Based on

events leading to the accident, it is probable that the Pilot was not prepared for such an occurrence.

The Helicopter, even after losing the TR thrust, flew straight ahead, made a turn, descended and climbed. Judging from these actions, it is probable that prior to the left turn, there were no major difficulties in operating the Helicopter. As described in 2.7.1, in the vicinity of Lake Miyagase, there is an open grassy space, a vacant lot, a sports field, a riverbed, farmland, and other areas that appear to be larger than 100 meter square. If the Pilot had selected an appropriate emergency landing sites from among these areas before flight and was well prepared to decide where to make an emergency landing according to the flight route, it is possible that he could have made an emergency landing at an earlier time rather than continuing to fly for an unnecessarily long period of time.

According to the statement in 2.1 b., while flying over Lake Miyagase, the Pilot requested a ground operator for permission to land at a site which the Pilot assumed to be a sports field, in response to which the ground operator informed the Pilot of the Kiyokawa heliport.

As described in 2.10.1, based on the “Emergency Procedures” in the Flight Manual, the Helicopter is presumed to have been in an emergency situation at this moment requiring the Pilot to make an autorotative landing at a suitable area as early as possible. Therefore, if the Pilot had recognized the seriousness of the emergency situation and had found a place suitable for an emergency landing, it is highly probable that he should have landed there immediately.

According to the statements in 2.1 a. and e., the Pilot, after passing over the Arai helipad, turned right and headed south, and asked the onboard mechanic to locate the Kiyokawa heliport on a map. It is probable that the Pilot turned right somewhere near the lake and continued on his chosen route and, while searching for the heliport, approached the vicinity of the accident site.

(See Figure 5 “Chain Reaction of Contributing Factors to the Accident.”)

#### **3.4.4 Uncontrollable Helicopter and the Crash**

As described in 3.4.2 e., it is considered probable that after losing the TR thrust, damage to the surrounding structure caused by the gyrating flexible coupling continued to worsen, the TR control rod was fractured, and the upper surface of the tail boom was scraped off.

As described in 2.7.2 d., dents on the upper surface of the tail boom were observed as a result of being hit by the flexible coupling. From the point on the outside of the flange of the TR drive shaft cover where the dents had extended to, a rupture was seen that appears as if the outer shell had been torn apart. Based on this observation, it is probable that the rupture expanded in a short period of time.

A leftward force is constantly applied to the tail section as described in 2.11.4. It is therefore probable that when the upper surface of the tail boom was cut off and its structure became too weak to resist the force, the outer shell suddenly ruptured followed by the tail part bending obliquely downward to the left, which made it impossible to counteract the antitorque of the MR. It is also probable that at that moment, the Helicopter started to yaw to the left uncontrollably and the horizontal stabilizer was no

longer capable of producing the nose up effect, resulting in a crash with the nose pointing downward.

Following the crash, the tail section was found near the crashed airframe and was connected to the tail boom by the tail guard. Judging from this observation, it is probable that the tail section that ruptured during the flight was hanging from the tail boom that was connected by the tail guard as it fell.

As described in 2.7.1, the TR and TGB were not found near the accident site. Based on the photos of the Helicopter taken before the crash as shown in 2.8, it is probable that the TGB that tilted backwards had been supported by the vertical stabilizer in such a way that the TR blade pierced it; however, immediately before reaching the accident site, the tail section ruptured and was bent down, causing the TR and TGB to separate and drop off.

Considering all of the above, it is probable that the Helicopter sling cable contacted the TR, damaging the tail section and resulting in a loss of TR thrust. The Pilot, however, did not make an emergency landing at the earliest possible time as stipulated in the Japanese Flight Manual. Instead, it is probable that he continued to search for an emergency landing site, during which time the damage to the tail section, including the vertical stabilizer, was exacerbated leading to its rupture, and the Helicopter became uncontrollable and crashed.

According to the statement in 2.1 a., the Pilot gave instructions to the onboard mechanic to keep searching for an emergency landing site until immediately before the Helicopter became uncontrollable. It is therefore probable that the Pilot continued flying without anticipating the possibility that the damage to the Helicopter could worsen making the Helicopter uncontrollable.

(See Figure 5 “Chain Reaction of Contributing Factors to the Accident.”)

### **3.5 Training of the Pilot**

As described in 2.9.2, the Company twice provided the Pilot with training on preparing for TR failure. The objective of both training programs was to provide training on runway landings based on the assumption of an uncontrollable TR. In these two training sessions, helicopters other than the type involved in the accident were used. Both sessions were provided more than four years and nine months prior to the accident itself. Training on autorotation to respond in the event of engine failure was provided roughly six months before the accident; however, no training on autorotation landing to respond in the event of a loss of TR thrust had been conducted.

Based on these training experiences, it is possible that the Pilot had difficulty deciding on whether to make an emergency landing by autorotation upon loss of TR thrust.

As described in 2.11.3 a., in response to the Aircraft Accident Investigation Report (AA11-4-1) published by the Japan Transport Safety Board related to the crash of a helicopter due to a TR failure that occurred in Shizuoka City in Shizuoka Prefecture, the CAB issued a notification to AJATS instructing the appropriate selection of training subjects for emergency procedures and other relevant issues. In response, the Company provided the information that was included in the notification throughout the organization. However, no review of training subjects was conducted because training related to TR failures had already been included as one of the elective subjects in a periodic training

program. As a result, the Pilot may not have had any opportunity to receive autorotation landing training to respond to the loss of TR thrust issues.

Safety measures taken by CAB should be taken seriously because their objective is to prevent the recurrence of similar accidents. It is therefore necessary for organizations that possess the helicopter concerned to appropriately analyze the current situation and ensure incorporation of the safety measures taken by CAB.

### **3.6 Company-wide Sharing of Safety Information**

As described in 2.10.4, the Company received the SL but did not distribute it to the Flight Operations Department. As a result, the following information included in the SL was not reflected in the regulations and other relevant Department documents: the weight of the ballast at the hook section after unloading should be at least 15 kg and, during descents or flights at an airspeed above  $V_y$  or with load factors less than 0.5 g, the sling cable can become unstable. It is therefore probable that the information had not been appropriately communicated to the Pilot.

As described in 2.11.3 b., in response to the Aircraft Accident Investigation Report (AA09-10-1) published by the Japan Transport Safety Board related to an emergency landing due to an engine shutdown that occurred in Yao City in Osaka Prefecture, CAB issued a notification to AJATS that instructed awareness of safety information provided by manufacturers and other sources, and accurate communication of information on failures and defects within a company. Although the Company circulated this notification within the organization, the failure described above occurred.

With regard to notifications issued, particularly on safety information, it is necessary for relevant companies not only to circulate the notifications within their organizations but also to appropriately discuss the current issues that need to be addressed and necessary measures to take, and to ensure that identified problems are dealt with.

### **3.7 Descriptions of the Flight Manual**

As described in 2.10.2, in the English manual, based on which the Japanese Flight Manual for the Aircraft was developed, the following description in the Caution section states: "Flying with an un-ballasted sling cable or empty net is prohibited." However, in the Japanese Flight Manual, caution that is required to be exercised by pilots when towing a sling cable is described as follows: "Flying with a cable with no load attached or with an empty net slung beneath the helicopter is prohibited," and makes no mention about the ballast.

The Japanese Flight Manual should be revised to include the statement that flying with an un-ballasted sling cable is prohibited.

### **3.8 Prevention of Sling Cable Contact with the Helicopter and How to Respond to a Loss of TR Thrust**

- a. Based on the information provided in the SL mentioned in 2.10.4, the following measures should be taken to prevent the sling cable from contacting the airframe:
  - (1) If towing a sling cable without any attached load, an appropriate amount of ballast should be attached to the hook to maintain the balance of the sling cable.
  - (2) During a flight, sudden sharp movements should be avoided, as should a reduction in load factor and sudden lowering of the tail section.
  - (3) While being towed, the sling cable should be monitored appropriately with a rearview mirror or other device, and an airspeed at which an appropriate distance to the airframe can be ensured should be maintained.
- b. To be prepared for accidents such as in this case where the TR lost thrust, it is generally necessary to take the following measures:
  - (1) Pilots should select appropriate emergency landing sites before flight and should always keep these selected sites in mind and be prepared for an emergency, including knowing which site to choose in different situations.
  - (2) If worsening damage to the airframe, which can result in increased difficulty operating the helicopter, is a possibility, pilots should make an emergency landing as soon as possible.
  - (3) Training on emergency procedures should periodically be provided so that pilots can maintain necessary skills.

#### 4. PROBABLE CAUSES

It is probable that the accident occurred as follows: The Helicopter sling cable contacted the TR, damaging the tail section and resulting in a loss of TR thrust. The Pilot, however, did not make an emergency landing as soon as possible as stipulated in the Japanese Flight Manual, but instead continued to search for a suitable emergency landing site, during which time the damage to the tail section, including the vertical stabilizer, was exacerbated leading to its rupture, and the Helicopter became uncontrollable and crashed into the ground.

It is possible that the sling cable contacted the TR because the Pilot increased the airspeed excessively without carefully monitoring the movement of the sling cable with the mirror; because when the Pilot adjusted the flight route downward, the load factor decreased, causing the distance between the end of the sling cable and the tail section to decrease; and because the movement of the end of the sling cable became unstable due to insufficient ballast weight.

It is probable that the Pilot failed to make an emergency landing as soon as possible as stipulated in the Japanese Flight Manual because he had not selected appropriate emergency landing sites before flight and was not prepared for emergency, including which landing site to choose in a given situation; and because the Pilot continued flying without anticipating the possibility that the damage to the Helicopter could worsen making the Helicopter uncontrollable.

## 5. SAFETY ACTIONS

### 5.1 Safety Actions Taken by the Company

- a. Amendment to Flight Procedures
  - (1) Flying with a light-weighted hook alone slung beneath the helicopter will be prohibited. Based on the SL, it was decided that the hook section must be at least 15 kg in weight.
  - (2) After unloading cargo, the descending airspeed of a helicopter with a sling cable shorter than 10 meters must be  $V_y$  or lower.
  - (3) If an airflow disturbance is present, the maximum airspeed of a helicopter carrying a load slung beneath it must be  $V_y$ .
- b. Amendment to the Procedures for Training and Assessment
  - (1) Special training on emergency procedures for TR failures and procedures for selecting emergency landing sites was provided to all pilots. Training on TR failures, which was formerly one of the elective subjects in a periodic training program, is now a mandatory subject.
  - (2) Periodic assessment of the flying skills of pilots engaged in cargo transportation carrying a load slung beneath the helicopter will now be made. In addition, a new "Skill Assessment Form" has been developed to check on skills in detail at each step of the flying process.
  - (3) Sessions on safety by expert pilots and periodic question and answer opportunities will now be implemented.
- c. Establishment of a Safety Management Department

A department that directly reports to the President was newly established to confirm that no problems related to laws and regulations exist, as well as to confirm safety prior to issuing work instructions and other relevant documents in order to ensure the safety of flight operations.
- d. Amendment to the technical information communication system

It has also been decided that departments that receive technical information from manufacturing companies or other relevant sources that contains information related to other department(s) are required to report the information, regardless of the content, to the Company's Safety Promotion Committee, which is then required to widely disseminate said information to all departments involved.

### 5.2 Measures taken by the Civil Aviation Bureau (CAB)

Following the accident, the Tokyo Civil Aviation Bureau of the MLIT conducted a safety audit inspection of the Company, and the Company took measures to prevent the recurrence of similar accidents, including amending the flight procedures based on the SL. It was later confirmed that the content of the SL on which the amendment of the flight procedures was based included safety-related information that may serve as a useful reference to other companies. The Tokyo Civil Aviation Bureau therefore provided these useful pieces of safety information to other companies and instructed them to consider to take necessary measures. These useful pieces of information were also provided to the Osaka Civil Aviation Bureau of the MLIT, which in turn communicated the similar

information to companies under its jurisdiction and instructed them to take necessary measures.

### **5.3 Measures taken by the Design and Manufacturing Company**

Eurocopter Japan Co., Ltd., the documents administrator of the Japanese Flight Manual attached to the Type Certificate, filed an application for approval of a change in the Caution section of the Japanese Flight Manual, as described in 2.10.2, to include the description of “ballast,” which is included in the English version, and then on November 15, 2012, received approval from the Civil Aviation Bureau to include the following sentence:

“Flying with an un-ballasted sling or empty net is prohibited.”

Eurocopter Japan Co., Ltd. has sent the change to the users of the type of helicopter on November 29, 2012.



Figure 1 Estimated Flight Path

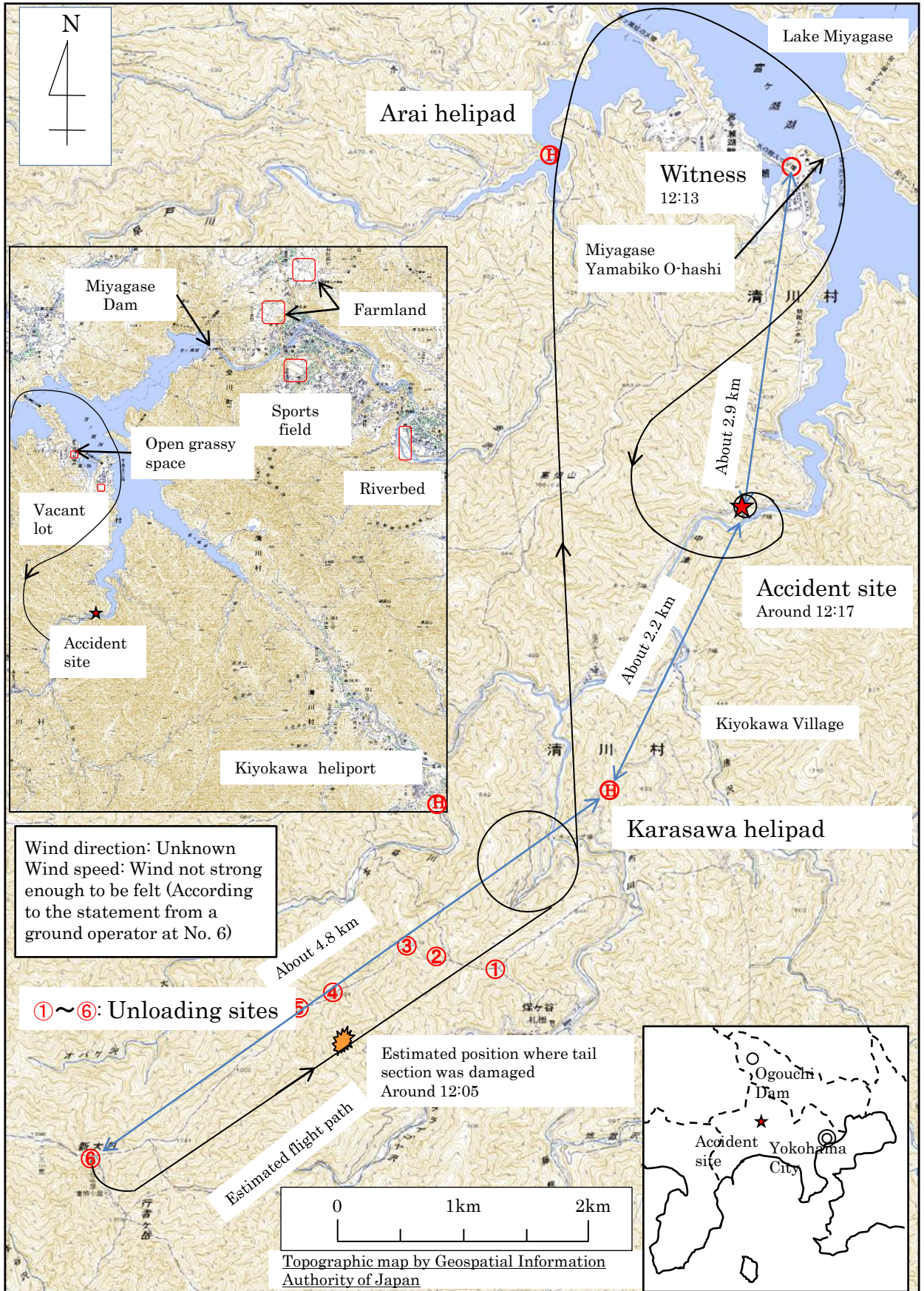

Figure 2 Accident Site

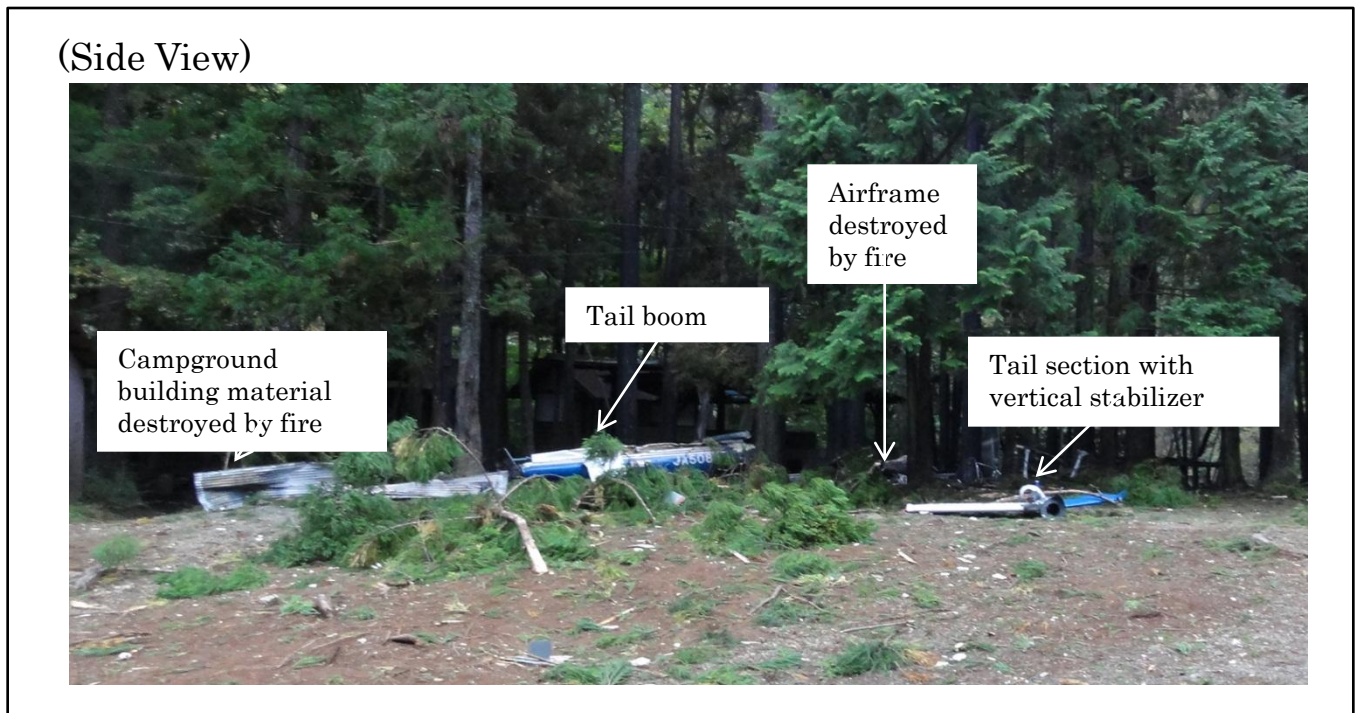
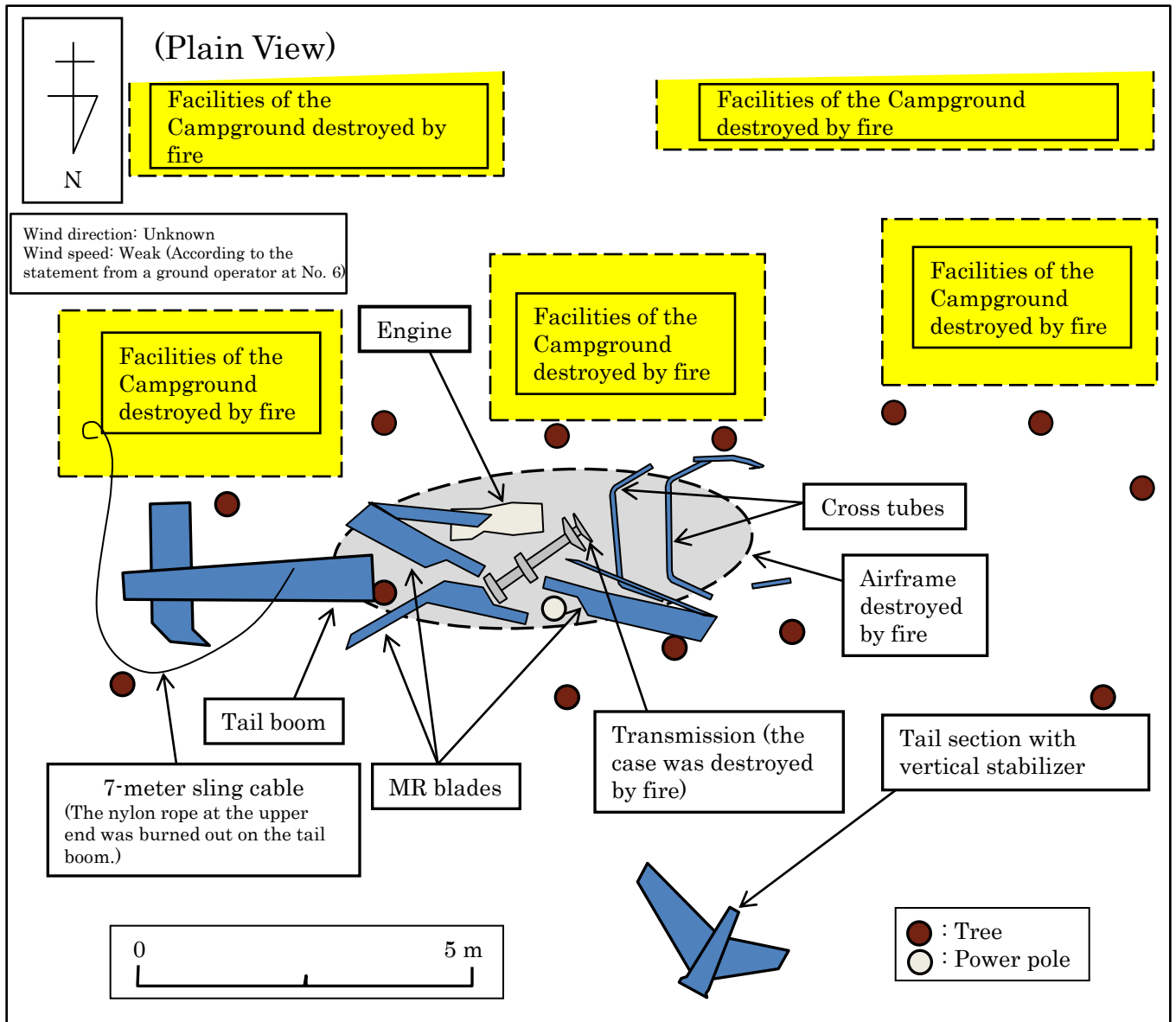
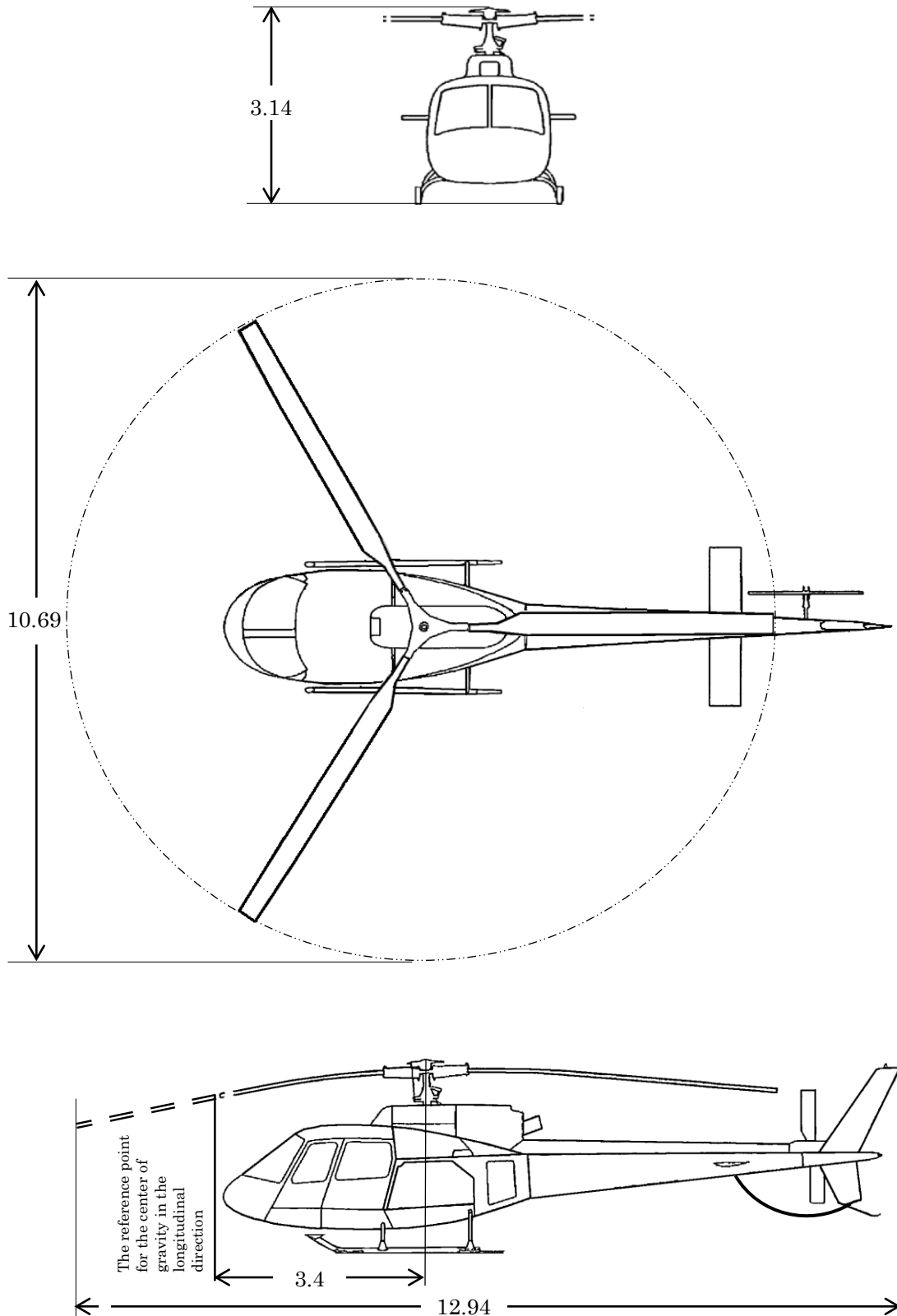
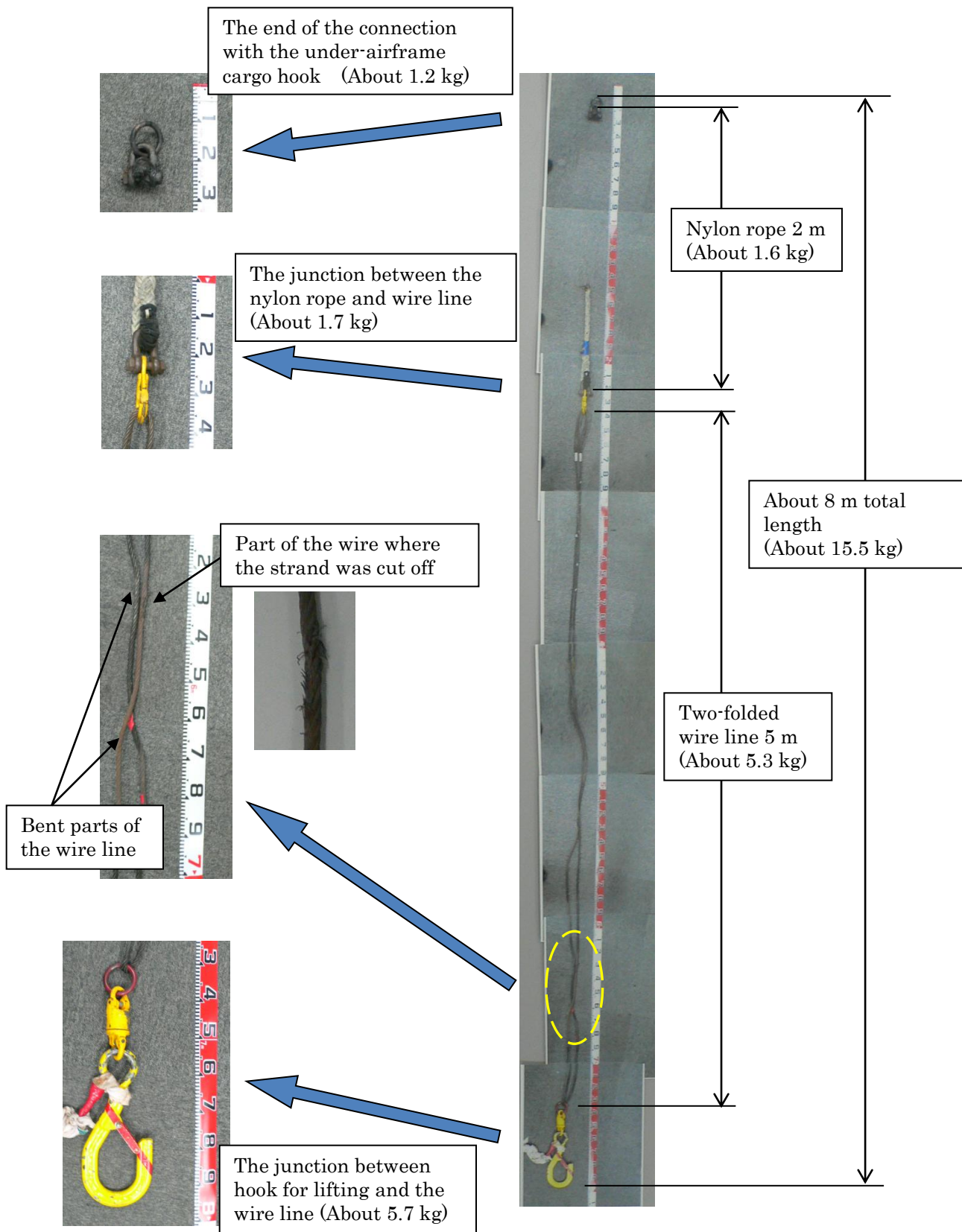

Figure 3 Three-Angle View of Eurocopter AS350 B3

Unit: m



# Figure 4 Seven-meter Sling Cable



# Figure 5 Chain Reaction of Contributing Factors to the Accident

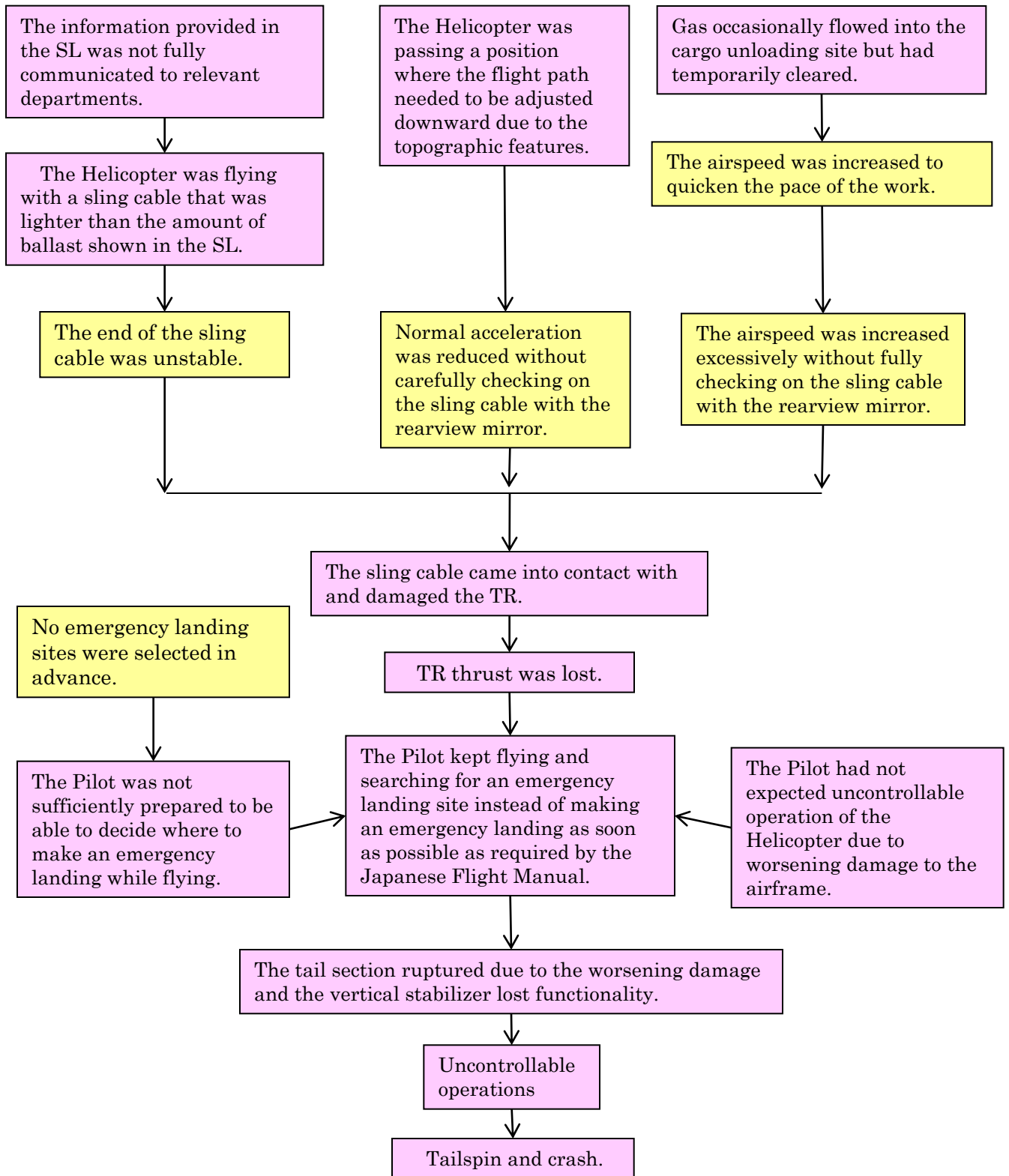

- Events that are verified to a high degree based on the accident site situation, the statements by those involved, and other information
- Events that were likely to have occurred based on related situations

# Photos of the Helicopter Involved in the Accident (Ruptured Surface of Tail Boom and Tail Guard)

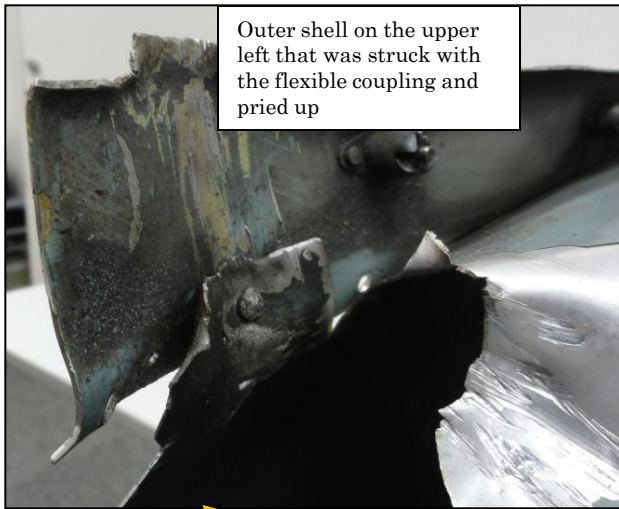

Outer shell on the upper left that was struck with the flexible coupling and pried up

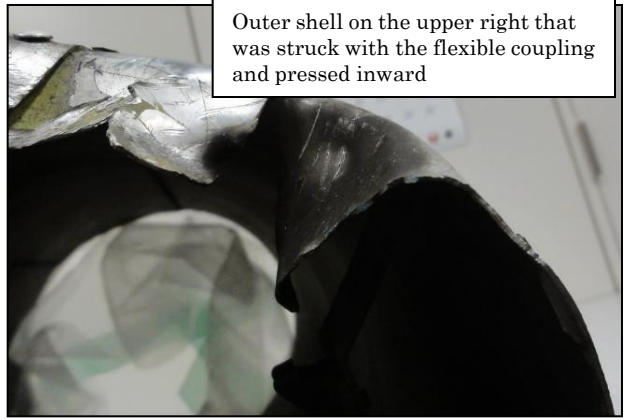

Outer shell on the upper right that was struck with the flexible coupling and pressed inward



Outer shell on the left that was torn apart

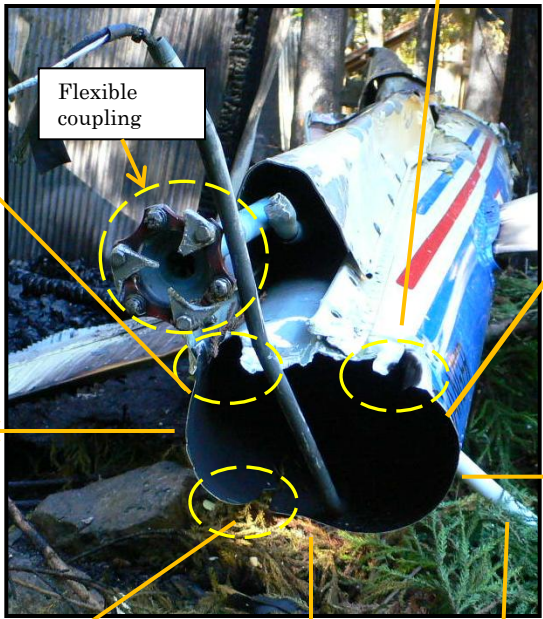

Flexible coupling



Outer shell on the right that was torn apart

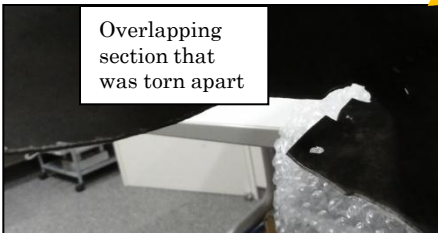

Overlapping section that was torn apart



Outer shell on the bottom that was torn apart

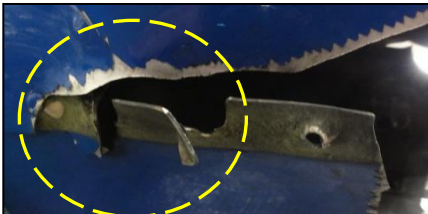

Rivets on the overlapping section that were pulled out, along with the outer shell, from the inner outer shell

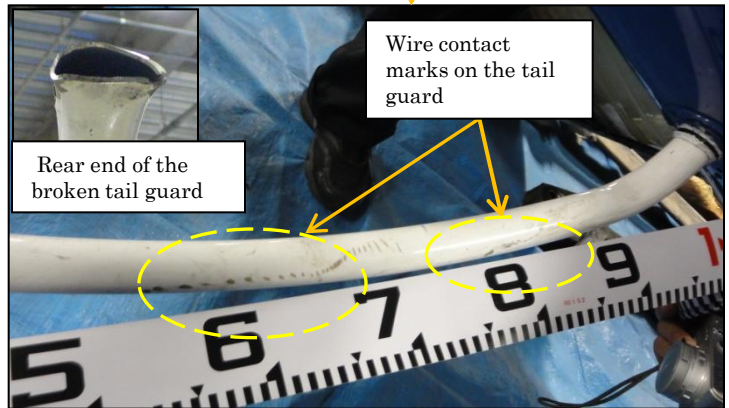

Wire contact marks on the tail guard

Rear end of the broken tail guard