

AA2015-6

**AIRCRAFT ACCIDENT  
INVESTIGATION REPORT**

**PRIVATELY OWNED  
J A 4 1 5 9**

**June 25, 2015**

The objective of the investigation conducted by the Japan Transport Safety Board in accordance with the Act for Establishment of the Japan Transport Safety Board and with Annex 13 to the Convention on International Civil Aviation is to determine the causes of an accident and damage incidental to such an accident, thereby preventing future accidents and reducing damage. It is not the purpose of the investigation to apportion blame or liability.

Norihiro Goto  
Chairman,  
Japan Transport Safety Board

Note:

This report is a translation of the Japanese original investigation report. The text in Japanese shall prevail in the interpretation of the report.

# AIRCRAFT ACCIDENT INVESTIGATION REPORT

## PRIVATELY OWNED BEEHCRAFT A36, JA4159 DAMAGE DURING LANDING ON THE RUNWAY AT MATSUYAMA AIRPORT AT AROUND 18:27, OCTOBER 26, 2013

June 5, 2015

Adopted by the Japan Transport Safety Board

Chairman	Norihiro Goto
Member	Shinsuke Endoh
Member	Toshiyuki Ishikawa
Member	Sadao Tamura
Member	Yuki Shuto
Member	Keiji Tanaka

### SYNOPSIS

#### <Summary of the Accident>

At around 15:44 on Saturday, October 26, 2013, a privately owned Beechcraft A36, registered JA4159, departed Kikai Airport for a cross-country flight. When JA4159 landed at Matsuyama Airport at around 18:27, it got damage to the airframe.

On board the aircraft was a captain who was not injured.

The aircraft sustained substantial damage, but there was no outbreak of fire.

### <Probable Causes>

It is highly probable that this accident occurred, when the aircraft made a night landing, it touched down hard on the runway from the nose gear without securing pitch-up attitude because the captain's maneuver was too lagged in raising the nose just before touchdown. Consequently, the aircraft sustained damages to the airframe including the nose gear.

Regarding the captain's lagged maneuver in raising nose just before touchdown, it is probable that it was because he had made a misjudgment about the height of the aircraft from the runway surface. Additionally, it is probable that the captain could not check the airspeed of the aircraft before making the flare because its instrument lights were not illuminated. It is probable that this also contributed to the captain's lagged maneuver in raising the nose.

The main abbreviations used in this report are as follows.

ATIS	: Automatic Terminal Information Service
GPS	: Global Positioning System
NOTAM	: Notice to Airmen
PAPI	: Precision Approach Path Indicator
VFR	: Visual Flight Rules
VMC	: Visual Meteorological Conditions

Unit conversion chart

1kt	: 1.852km/h (0.5144m/s)
1nm	: 1,852m
1ft	: 0.3048m
1in	: 2.54cm
1lb	: 0.4536kg

# **1. PROCESS AND PROGRESS OF THE AIRCRAFT ACCIDENT INVESTIGATION**

## **1.1 Summary of the Accident**

On Saturday, October 26, 2013, a privately owned Beechcraft A36, registered JA4159 departed Kikai Airport for a cross-country flight at around 15:44. When it landed at Matsuyama Airport at around 18:27, it got substantial airframe damage.

On board the aircraft was a captain who was not injured.

The aircraft sustained substantial damage, but there was no outbreak of fire.

## **1.2 Outline of the Accident Investigation**

### **1.2.1 Investigation Organization**

On October 26, 2013, the Japan Transport Safety Board designated an investigator-in-charge and another investigator to investigate this accident.

### **1.2.2 Representatives of the Relevant State**

An accredited representative of the United States of America, as the State of Design and Manufacturer of the aircraft involved in this accident, participated in the investigation.

### **1.2.3 Implementation of the Investigation**

October 27, 2013	Interviews and on-site investigation
October 28 and 29, 2013	On-site investigation and airframe examination
November 1, 2013	Interviews
November 14 and 15, 2013	Airframe examination and interviews

### **1.2.4 Comments from the Parties Relevant to the Cause of the Accident**

Comments were invited from parties relevant to the cause of the accident.

### **1.2.5 Comments from the Relevant State**

Comments on the draft report were invited from the relevant State.

## **2. FACTUAL INFORMATION**

### **2.1 History of the Flight**

At around 15:44 on October 26, 2013, a privately owned Beechcraft A36, registered JA4159 (hereinafter referred to as “the Aircraft”) departed Kikai Airport for Matsuyama Airport (hereinafter referred to as “the Airport”) for a cross-country flight. The Captain, only

the person on board, sat in the left seat.

The flight plan of the Aircraft is outlined below.

Flight rules: Visual flight rules (VFR), Departure aerodrome: Kikai Airport, Estimated off-block time: 15:30, Cruising speed: 150 kt, Cruising altitude: VFR, Route: Tanegashima-Miyazaki-Oita, Destination aerodrome: Matsuyama Airport, Total estimated elapsed time: 3 hours 00 minutes, Fuel load expressed in endurance: 3 hours 30 minutes, Persons on board: 1

According to ATC communication records, records of the handheld GPS device which was brought into the Aircraft by the Captain (hereinafter referred to as “GPS”) and statements from relevant persons, the Aircraft’s flight history up to this accident was as outlined below.

### 2.1.1 History of the Flight based on GPS Records and ATC Communication Records

The Aircraft’s flight route based on GPS records is shown in the figure below. The flight altitude in the figure are shown by the GPS altitude\*1.

The overview of ATC communication records from the approach through the landing at the Airport were as follows.

- 18:22:20 The Captain reported to the Air Traffic Controller in Matsuyama Airport. (hereinafter referred to as “the Tower”) that JA4159 had passed the South Point \*2
- 18:22:23 The Tower instructed the Aircraft to report at the right downwind of Runway 14 (hereinafter referred to as “the Runway”), and the Captain read back the instruction.
- 18:22:56 The Tower reported that the preceding arrival aircraft was passing 5 nm final, and verified the Captain’s visual contact of it.
- 18:23:05 The Captain reported that he had the preceding aircraft in sight.

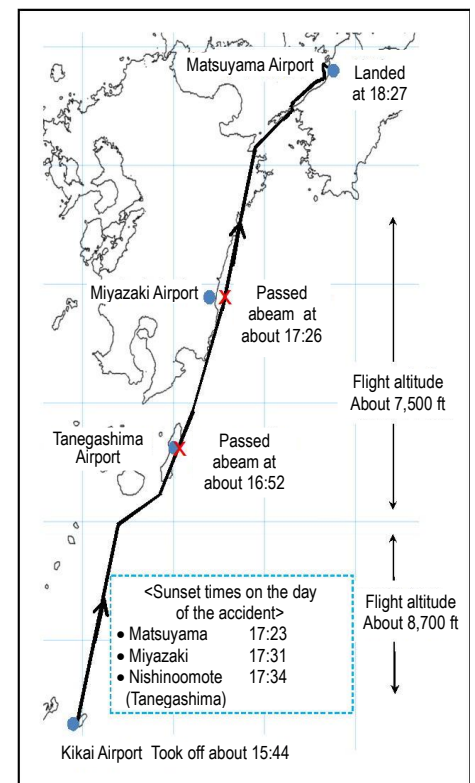

**Estimated Flight Route**

\*1 In this Report, “GPS altitude” is the altitude recorded on GPS, not the pressure altitude shown on the aircraft’s altimeter.

\*2 “South Point” is a reporting point based on visual flight rules (VFR) located 9 km south-southwest of the Airport.

18:24:37 The Captain asked, “Excuse me, but I have not confirmed it yet and I will fly a bit further away. Is that OK?”

18:24:42 The Tower reported that the preceding aircraft was flying just before the Runway, and asked whether the Captain could have the preceding aircraft in sight, but the Captain did not reply.

18:24:54 The Tower instructed the Captain to report on the base leg.

18:25:01 The Captain read back the reporting on the base leg.

18:25:20 The Tower reported that the preceding aircraft had landed, and issued the landing clearance with information of wind 040° and 9 kt on the Runway.

18:25:42 The Captain read back the landing clearance.

18:27:18 The Tower instructed taxiing to the apron with the exit taxiway.

18:27:29 The Captain replied, “Sorry. It’s a bit, (part omitted) ...Oh–”

18:27:39 The Tower asked whether the Captain could hear his instruction.

18:27:42 The Captain replied, “Yes.”

18:27:47 The Tower cleared to taxi to the apron again.

18:27:52 The Captain reported that the engine had stopped.

18:27:57 The Tower asked whether the Aircraft could propel itself. Then, the Captain answered in the negative.

18:28:37 The Tower reported that towing vehicles would be called out to the site, and asked whether anyone were injured. The Captain reported that he did not get injured.

18:29:16 The Tower announced the closure of the Runway to all relevant stations.

### **2.1.2 Statements from relevant persons**

#### **(1) The Captain**

The Airport was his base station and the Captain had made cross-country flights regularly once or twice a month. The Captain planned a one-day flight for Kikai Airport on that day.

Leaving Tokyo at about 06:00, the Captain moved to the Airport by air. The Captain made a solo flight with the Aircraft, departing the Airport at 10:00, then arriving at Kikai Airport at 12:28. After staying in Kikai Island for about three hours, the Captain got started his preparations for the returning flight to the Airport.

The Captain expected that the Aircraft would be flying in a night flight during the latter half of the flight to the Airport, however, he did not performed the



operational check of the internal lights\*<sup>3</sup> such as the instrument lights\*<sup>4</sup> as well as the external lights such as landing lights on his pre-flight inspection. The Captain was also not prepared for his own flashlight for the night flight.

On his pre-flight inspection, the Captain noticed that the annunciator\*<sup>5</sup> second from the right (“GYRO WARN”), being not illuminated though, was slightly popped out from the mounted position, and he was afraid of some potential troubles with the aircraft’s electrical system. The Captain hesitated what to do, however, he eventually pressed the annunciator into its mounted position and decided to leave it there and allowed the Aircraft to fly.

In a little time after the Aircraft departed Kikai Airport, the Captain tried to operate the PANEL switch on the left subpanel\*<sup>6</sup> to illuminate the instrument lights since it became dark around there with dusk approaching. However, the instrument lights did not illuminate. Because the Captain did not know that there were dimmers of instrument lights on the right subpanel\*<sup>7</sup>, and he could illuminate the instrument lights just by operating the PANEL switch in his past night flights, he repeatedly turn the PANEL switch on and off. However, the instrument lights did not work. At this moment, the Captain was afraid that he might have caused an electrical failure because he pressed the annunciator that was popped out in the pre-flight inspection and that the instrument lights might be probably not working any more. Thus, at first, the Captain feared that he would have been forced to make a night landing in a state of no instrument lights, however, he thought that he could probably manage somehow because the Airport was the most familiar one to him. After that, the Captain continued to fly while checking the instrument readings illuminated with on-board waterproof portable light\*<sup>8</sup> in the Aircraft (hereinafter referred to as “Waterproof Portable Light”).

---

\*3 In this Report, the term “lights” is used to mean the lights equipped in the Aircraft.

\*4 “Instrument lights” are lights equipped inside flight instruments, engine instruments and others in the cockpit, enabling the instruments to be read at night.

\*5 An “annunciator” is a warning light that indicates the operational status as well as abnormalities in the primary equipment located at the front of the cockpit. It is not supposed to protrude from its mounted position even when there is an abnormality in the equipment (see p.12, Layout of Switches in the Aircraft’s Cockpit).

\*6 The “left subpanel” is located beneath the left cockpit control stick. The master switch, light switches and others are installed in it (see 2.8.3).

\*7 The “right subpanel” is located beneath the right cockpit control stick. The flap levers and internal light dimmers and others are installed in it (see 2.8.3).

\*8 The “waterproof portable light” is one of the emergency equipment that must be carried by aircraft under Article 62 of the Civil Aeronautics Act. Waterproof portable lights are supposed to be carried by aircraft when their take-off or landing path lies over water, as in this case.

While approaching to the Airport, the Captain monitored ATIS\*<sup>9</sup> and obtained the Airport information of VMC\*<sup>10</sup>, Runway 14 in use, and light tail wind condition with 10 kt crosswind. The Captain was not concerned about such tailwind and crosswind because he believed that he was proficient in crosswind landing. Moreover, the Captain was also not worried about the night landing. However, the Captain planned to approach at a slightly higher speed than normal in order not to cause the Aircraft's stall because he expected to be unable to continuously check the reading on the airspeed indicator as there would be no instrument lights during final approach.

The Captain intended to enter the downwind leg at an altitude of around 1,500 ft. While approaching to the Airport, the Captain reported South Point and the Tower requested him to report the right downwind leg of the Runway.

The Captain extended the landing gear and set the flaps to the approach position\*<sup>11</sup> while heading downwind leg.

Around entering the downwind leg, the Captain intended to extend the downwind leg and confirm the position of the Runway exactly and then enter the base leg; therefore, the Captain reported that he could not confirm the Runway and asked the Aircraft to fly a bit further away. After that, however, the Captain felt like that he was advised the Tower had the Aircraft in sight. For this reason, the Captain turned his attention toward the Airport again, and soon he could see the Runway. Therefore, the Captain reconsidered that it would be all right to directly enter the base leg right away without extending downwind leg, and started his base turn. After this, the Captain got landing clearance from the Tower.

When the Aircraft turned onto final approach, the Captain confirmed that PAPI\*<sup>12</sup> showed two whites and two reds, and that it was flying on the proper glide path. He then confirmed the instrument reading with the illumination of the Waterproof Portable Light that the Aircraft was flying at an altitude of around 300 ft and at a speed of around 100 kt.

Usually, the Captain made it a point to turn onto the final approach with the

---

\*9 "ATIS" is a system that uses ground-to-air transmission (broadcasting) to provide the necessary meteorological information for taking off or landing, the state of the airfield, and other information to aircraft taking off from or landing at airports and airfields.

\*10 "VMC" is an abbreviation for Visual Meteorological Conditions.

\*11 The "approach position" is one of the flap positions. When landing, the pilot can choose either the "down position" or the "approach position" for the flaps (see 2.8.5).

\*12 "PAPI" (Precision Approach Path Indicator) is a series of indicator lights set beside the runway, near the touchdown point. When pilots can see two white and two red lights, the approach angle at that time is within the correct range of about 3°.

flap setting in the approach position, and then judging whether to set the flaps in the down position. After that, the Captain made it a point to turn the landing light on. The Captain could not remember whether he had set the flaps in the down position at the time. Then, the Captain looked for the landing light switch on the left subpanel but could not find it because the internal lights of that panel were dark, accordingly, he gave up turning the landing light on in fear that he might be likely to operate the wrong switch by mistake in such a situation. Nevertheless, the Captain believed that he could make a safe landing as what the Aircraft was in, and never had a think of executing a go-around.

The Captain intuitively felt that the Aircraft was flying at around 90 kt when it passed over the Runway threshold. He raised the nose once or twice with reducing power. As the Aircraft was gradually approaching to the Runway, the Captain felt it difficult to judge the height of the Aircraft from the Runway surface because of no landing light. Then, just when the Captain was about to raise the nose, as the final flare maneuver, before touchdown, the Aircraft touched down on the Runway from the nose gear with a hard impact. After bouncing, the Aircraft continued to move on the Runway with scraping noise something like being dragged. The heavy impact in this landing did not allow the Captain to carry out any maneuvers such as braking or controlling its direction, and he could not understand about what was happening. The Aircraft came to a halt on the Runway. The Captain reported to the Tower that the engine had stopped and the Aircraft could not propel itself. Then the Captain turned off the master switch and such to prevent fire occurring from the engine.

During the flight, the Captain had not noticed any abnormality with the engine or flight control system.

(2) The Tower

At the time of the accident, the Airport was not congested with departures and arrivals.

The Captain reported to the Tower around his downwind leg that he had something not verified. The Tower speculated that the Captain could not confirm the aircraft to be followed for approach, therefore, the Tower reported the position of the preceding aircraft to him. Then, the Tower issued landing clearance for the Runway after instructing to report at the base leg.

The Tower did not remember the landing light status of the Aircraft during landing whether it illuminated or not, and did not know that the Aircraft had made a hard landing and suffered some damage in a part of the airframe. The Captain reported that the Aircraft could not propel itself due to its engine stopping, adding

no physical damage on himself. Not until then the Tower had recognized that the Aircraft fell into something unusual condition after landing.

As a result, the Tower announced the closure of the Runway to all relevant stations .

(3) The Witness

The mechanic in the ramp area of the Airport, as a witness of this accident, had been observing the Aircraft landing. The Aircraft's landing light was not illuminated when it landed. The mechanic could not see the moment of touchdown, however, the mechanic was afraid that there was something wrong with the Aircraft during landing because he could see the Aircraft moving on the Runway with shooting sparks.

This accident occurred on the Runway of the Airport (N33°49'45", E132°41'49") at around 18:27 on October 26, 2013.

(See Figure 1: Estimated Flight Route on the Approach to Matsuya Airport)

## 2.2 Injuries to Persons

No one was injured.

## 2.3 Damage to the Aircraft

### 2.3.1 Extent of Damage

Substantial

### 2.3.2 Damage to the Aircraft Components

- (1) Fuselage : Damaged
- (2) Propeller : Blades damaged
- (3) Landing gear : Nose gear damaged

(See Photo 1: Accident Aircraft)

## 2.4 Personnel Information

Captain Male, Age 63

Private pilot certificate (Airplane)

Type rating for single-engine piston(land) November 20, 2007

Class 2 aviation medical certificate

Validity January 5, 2014

Total flight time 532 hr and 35 min

Flight time in the last 30 days	17 hr and 18 min
Total flight time on the type of aircraft	375 hr and 48 min
Flight time in the last 30 days	17 hr and 18 min

## 2.5 Aircraft Information

### 2.5.1 Aircraft

Type	Beechcraft A36
Serial number	E-2732
Date of manufacture	June 8, 1992
Certificate of airworthiness	NO. Dai-2012-519
Validity	December 25, 2013
Category of airworthiness	Aircraft Utility U
Total flight time	5,674 hr and 00 min
Flight time since last periodical check (100-hr check, 12/17/2012)	51 hr and 12 min

(See Figure 3: Three Angle View of Beechcraft A36)

### 2.5.2 Weight and Balance

At the time of the accident, the weight of the Aircraft is estimated to have been 2,842 lb and the position of the center of gravity 78.07 in aft of the reference point (39 in forward of the engine firewall), both of which are estimated to have been within the allowable range (maximum take-off weight of 3,650 lb, range of position of center of gravity corresponding to the weight at the time of the accident, 74.0-87.7 in).

## 2.6 Meteorological Information

### 2.6.1 Weather Conditions at the Airport

The routine weather report at the Airport on the day of the accident were as follows.

18:00 Wind direction 020°; Wind velocity 10 kt; Visibility 10 km or more

Cloud	Amount FEW* <sup>13</sup>	Type Cumulus	Cloud base 4,000 ft
	Amount SCT* <sup>14</sup>	Type Stratocumulus	Cloud base 6,000 ft
	Amount BKN* <sup>15</sup>	Type Altocumulus	Cloud base 8,000 ft

Temperature 18°C; Dew point 7°C

Altimeter setting (QNH) 29.90 inHg

---

\*13 "FEW" indicates that 1/8-2/8 of the sky is occupied by cloud.

\*14 "SCT" indicates that 3/8-4/8 of the sky is occupied by cloud.

\*15 "BKN" indicates that 5/8-7/8 of the sky is occupied by cloud.

19:00 Wind direction 060°; Wind velocity 5 kt; Visibility 10 km or more

Cloud      Amount FEW      Type Cumulus      Cloud base 4,000 ft

                 Amount SCT      Type Stratocumulus      Cloud base 8,000 ft

Temperature 17°C; Dew point 7°C

Altimeter setting (QNH) 29.92 inHg

### **2.6.2 Sunset and Moonrise Information**

On the day of the accident, the sunset was at 17:23 and the moonrise was at 23:06 in Matsuyama City. Accordingly, there was no moonlight at the Airport at around 18:27.

Meanwhile, the sunset times in the vicinity of the Aircraft's flight route on that day were at 17:34 in Nishinoomote City, Kagoshima Prefecture (about 15 km north of Tanegashima Airport) and at 17:31 in Miyazaki City (about 5 km northwest of Miyazaki Airport), respectively.

### **2.6.3 Weather Conditions at Other Airports in Kyushu**

According to the aeronautical weather report for Kyushu area released by the Fukuoka Aviation Weather Station of the Japan Meteorological Agency's on October 26, 2013, as high pressure system centered in China was gathering strength in the region on that day, the weather conditions at any airports in Kyushu area remained VMC whole day.

Meanwhile, the weather observations at 17:00 at Tanegashima Airport and Miyazaki Airport which were the nearest airports to the Aircraft's flight route on that day were as follows.

Tanegashima Airport (Aviation weather report)

Wind direction 320°; Wind velocity 12 kt; Visibility 10 km or more

Cloud      Amount FEW      Type Cumulus      Cloud base 2,500 ft

Temperature 18°C; Dew point 9°C

Altimeter setting (QNH) 29.88 inHg

Miyazaki Airport (Aviation weather report)

Wind direction 190°; Wind velocity 7kt; Visibility 10 km or more

Cloud      Amount FEW      Type Cumulus      Cloud base 3,000 ft

                 Amount SCT      Type Stratocumulus      Cloud base 7,000 ft

Temperature 20°C; Dew point 9°C

Altimeter setting (QNH) 29.84 inHg

## 2.7 Accident Site and Debris Information

### 2.7.1 The Accident Site Description

The Airport's runway was 2,500 m long by 45 m wide, with magnetic bearing 137°/317° (Runway 14/32), and had runway lights, runway centerline lights and PAPI placed. On the day of the accident, these lights worked normally, and there was no NOTAM\*<sup>16</sup> that would affect the flight. The runway touchdown zone lights were not installed on the Runway.

There was a gouged mark about 385 m from the Runway threshold and 3 m of the right of the Runway centerline (Point A), followed by scratch marks, propeller hit marks, another gouged marks and such. One of the Runway centerline lights was damaged, and another gouged mark was remained in the intersection of the taxiway T-3 and the Runway (Point B), and beyond that point, continual gouged marks followed up to the Aircraft stop point.

Besides these, a nose-gear tire attached with a broken fork\*<sup>17</sup> was found around the entrance of taxiway T-2. Beyond that position, fragments of the propeller blades and metal pieces, which appeared to be debris of the cylinder of nose gear shock strut (hereinafter referred to as "Cylinder") and the piston of the nose gear shock strut (hereinafter referred to as "Piston"), were scattered around.

The Aircraft had come to a stop at the position of the left-side runway side strip marking about 900m from the Runway threshold.

(See Figure 2: Accident Site)

### 2.7.2 Detailed Descriptions of Damage

- (1) Fuselage : Wrinkling on lower outer plate of engine left-side access panel and lower outer plate in the center of the fuselage, two through-holes in the lower outer plate aft of the nose gear
- (2) Propeller : Bending and partial breakage of the tips of three propeller blades
- (3) Landing gear : Breakage of fork, damage in Cylinder and Piston, bending in nose gear door
- (4) Control systems : Jamming of Rudder pedal

(See Photo 1: Accident Aircraft, Photo 2: State of Damage to Various Parts)

---

\*16 "NOTAM" is a type of aviation information used to alert pilots and other relevant personnel without delay to changes in the settings or conditions of aeronautical facilities, services, procedures or hazards, etc.

### **2.7.3 Condition of Engine Levers and Other Control Systems and Electrical System**

In the post-accident investigation, the throttle lever was set in the idle position, the propeller control lever in the high rotation position, the flap lever in the up position, the landing gear lever in the down position, and the flaps were remained in the up position. The ailerons and elevators were working normally without being restricted in motion, and no anomaly was observed.

Also, no anomaly in the electrical system and any related items to “GYRO WARN” was observed.

## **2.8 Additional Information**

### **2.8.1 Confirmation before Departure**

Article 73–2 of the Civil Aeronautics Act (Confirmation before Departure) provides that the pilot in command shall not start an aircraft, unless he/she has confirmed that the aircraft has no problems for flight and the necessary preparation for air navigation has been completed. Meanwhile, Article 164–14 of the Ordinance for Enforcement of the Civil Aeronautics Act provides for the following specific matters to be confirmed.

*(1) Matters that must be confirmed by the pilot in command pursuant to Article 73-2 of the Act are as listed below:*

*(i) Maintenance status of a subject aircraft and its equipment*

*(Omitted)*

*(2) A pilot in command shall, in the case of confirming the matters listed under item (i), conduct the inspection of aircraft logbook and other records on maintenance services, inspection of the exterior of aircraft and ground trial run of engines, and other elemental inspection of aircraft.*

### **2.8.2 Descriptions on Illuminating of Lights in the Flight Manual**

The Aircraft Flight Manual stated about the pre-flight inspection in the normal operation that pilots should inspect (perform its operational check) external lights such as navigation lights<sup>\*18</sup> and landing lights and inspect instrument lights and other internal lights whenever necessary. It also stated that, in the operation prior to landing, pilots should illuminate landing lights whenever necessary.

---

\*17 The “fork” is a part of the nose-gear tire to hold the wheel.

\*18 “Navigation lights” indicate that wing tip lights of left and right and taillights. Also generally known as “aviation lights.”



### 2.8.3 Methods of Operating and Dimming Lights

#### (1) External lights

As shown in the figure “Layout of Switches in the Aircraft’s Cockpit” below, four (LIGHTS) are allocated in the left subpanel beneath left side control wheel, landing light switch (LDG) in the far right and the taxi light switch (TAXI) in the second from the right.

#### (2) Internal lights

As shown in the figure, among the lighting switches, the flood switch (FLOOD) for illuminating various instrument panels from the glare shield which is equivalent to canopy for the instrument panel, is allocated in the far left, and the panel switch (PANEL) for the various instrument lights in the second from the left, meanwhile, four internal light dimmers (PANEL LIGHT DIMMING) are allocated in the right subpanel beneath the right side control wheel.

Pilots can adjust the brightness of internal lights (instrument lights) of the flight instruments, the engine instrument and avionics by using the flight instrument dimmer (FLIGHT INST) at the upper left of internal lights dimmers (PANEL LIGHT DIMMING) and the engine instrument and avionics dimmer (ENG INST / AVIONICS) at the bottom left respectively, following turning on the panel switch described above. Even if Pilots turn on the panel switch, the instrument lights won’t illuminate when these dimmers are turned down to the off position.

Pilots also can adjust the brightness of the lighting from the glare shield by using the instrument flood dimmer (INST FLOOD) at the upper right of internal light dimmers (PANEL LIGHT DIMMING), following turning on the flood switch (FLOOD) described above. In the same manner mentioned above, the floodlight won’t illuminate when this dimmer (INST FLOOD) is turned down to the off position. Additionally, pilots could adjust the brightness of internal lights in the right-and-left subpanel by using the dimmer at the lower right (SUBPANEL LIGHTING).



### Layout of Switches in the Aircraft's Cockpit

#### 2.8.4 Condition of the Aircraft's Lights

In the post-accident investigation, the following facts were revealed.

##### (1) External lights

The landing light worked normally, while the taxi light did not work due to the filament's breaking.

##### (2) Internal lights

All four dimmers in the right subpanel were placed in the position where those were turned counterclockwise down to the off position.

The flight instrument dimmer (FLIGHT INST) and the engine instrument and avionics dimmer (ENG INST / AVIONICS) were able to adjust the brightness of the instrument lights respectively, following turning on the panel switch. The upper right dimmer (INST FLOOD) was able to adjust the brightness of the light to illuminate the instrument panel from the glare shield, following turning on the flood switch.

Besides, the lower right dimmer (SUBPANEL LIGHTING) was able to adjust the brightness of the internal lights in the right subpanel, but was not able to adjust those in the left subpanel. Further investigation revealed the breaking of the wire of the internal lights system in the left subpanel.

### **2.8.5 Approach Speed for Landing**

According to the Aircraft Flight Manual, the approach speed for landing in the type of the Aircraft is 79 kt in flap down position (30°). The approach speed for landing in flap approach position (12°) is not described in the Manual. In response to the inquiry, the manufacturer of the Aircraft replied that as a reference, the approach speed for landing in flap approach position (12°) is 83 kt.

### **2.8.6 The Captain's Flare Maneuver and the Operational Characteristics of the Type of the Aircraft**

The Captain stated that he was proficient in landing in either flap position, down or approach. And more, regarding the maneuver of landing flare\*<sup>19</sup> after passing runway threshold, the Captain told that he would routinely repeat to raise the aircraft's nose little by little with reducing power and then raise the nose as the final flare maneuver just before touchdown.

Generally, since this type of the aircraft has a specific pitch-down tendency when reducing power, pilots shall take good care of holding pitch-up attitude against heavier nose with reducing power. The Captain also told that he knew as much about this characteristics of this type of the aircraft.

## **2.9 Night Flight**

### **2.9.1 Caution Required for Night Flight**

The "Airplane Operation Textbook" (published by the Japan Civil Aviation Promotion Foundation supervised by the Civil Aviation Bureau, Ministry of Land, Infrastructure, Transport and Tourism, 3rd Edition, March 31, 2009; hereinafter referred to as "the Textbook") includes the following statements (excerpt).

#### *Chapter VIII Night Flight*

#### *8.3 Equipment for Night Flight*

*Before commencing night flight, the pilot should carefully consider personal equipment that should be readily available during the flight. (Omitted)*

---

\*19 "Flare" refers to the action of raising an aircraft's nose in order to reduce the descent rate and speed when landing.

*At least one reliable flashlight is the minimum standard equipment to carry on a night flight. (Omitted)*

## **8.6 Caution Required for Night Flight**

### **8.6.1 Preparation before the Flight**

*Carrying out a proper pre-flight inspection of the aircraft, as well as reviewing the emergency operation procedure for systems and equipment, and the way of handling of lighting equipment, is significant especially for night flight. (Omitted)*

### **8.6.5 Approach and Landing**

*When approaching the airport to enter the traffic pattern and land, it is important to identify the runway lights and other airport lighting as soon as possible.*

*(Omitted)*

*Due to limited lighting conditions at night, it is difficult to identify the reference on the ground or compare the sizes or locations of objects on the ground. Thus, distance might be deceptive at night. This also applies to the estimation of altitude and speed.*

*Consequently, more dependence must be placed on the flight instruments, particularly the altimeter and airspeed indicator. (Omitted)*

*Throughout the final approach, every effort should be made to surely control the aircraft and lead it for safe landing while carrying out coordinated operation of pitch and power to maintain the recommended airspeed and approach path. (Omitted) Flare and touchdown should be performed in the same manner as in day landings. At night, the judgment of height, speed, and sink rate are impaired by scarcity of observable objects in the landing area. (Omitted)*

*To aid in determining the proper flare point, continue a constant approach descent until landing lights reflect on the runway and tire marks on the runway surface or joint lines of the pavement can be seen. Upon reaching this point, the flare should be started smoothly, and then the throttle should be gradually reduced to the idle as the aircraft is touching down. (please refer to an example image on the right)*

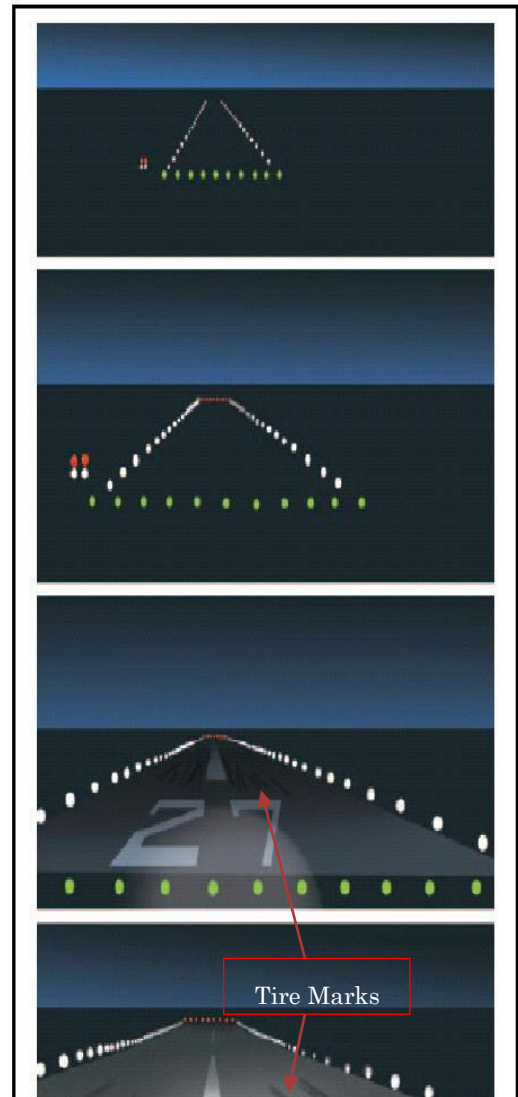

### **Reference Example of Flare with Tire Marks Visible**

Excerpt from Figure 10-6, Chapter 10 Night Operations, "Airplane Flying Handbook" (FAA-H-8083-3A), published by Federal Aviation Administration, USA

*When landing without the use of landing lights or landing in places where markings on the runway cannot be seen, flare should be started when the runway lights at the far end of the runway first appear to be rising higher than the nose of the aircraft. This demands a smooth and very timely flare, and require that the pilot feel for the runway surface by controlling the aircraft's pitch and power in a certain manner, to ensure that the aircraft lands slowly on the runway. (Skipped)*

## **2.9.2 The Captain's Experience and Perception of Night Landing**

According to the Captain's flight log, he had flown at night for 11 hours 33 minutes and made 33 night landings until this accident, the most recent night landing was made on November 6, 2009.

The Captain could not clearly remember whether he had made night landings with landing light in the past. The Captain stated that he had assumed the need for landing light during night landing varied depending on the situation at the time, and that landing light was not necessarily essential during night landing. The Captain also stated that he had never felt an uncomfortable difference between day landing and night landing in the point of perspective of the runway, and that he had not been particularly worried about making a night landing on that day, though he had not experienced night landings for the last few years.

## **3. Analysis**

### **3.1 Qualifications of Personnel**

The Captain held a valid airman competence certificate and a valid aviation medical certificate.

### **3.2 Airworthiness Certificate of the Aircraft**

The Aircraft had a valid airworthiness certificate, and had been maintained and inspected as prescribed.

### **3.3 Meteorological Conditions**

As described in 2.1.1, the Runway wind when the Tower issued landing clearance to the Aircraft was 040° at 9 kt, a left crosswind component of about 9 kt and a tailwind component of about 2 kt. This wind was almost the same as in ATIS which the Captain checked as described in 2.1.2 (1). It is therefore probable that the Captain did not think the wind at that time would affect the safe landing, and performed the flare without particular attention for the wind. Also, as described in 2.6.1, as the Airport was VMC, no problem with

visibility at the time of this accident. Consequently, it is probable that the meteorological conditions at the time of the accident did not contribute to the occurrence of the accident.

### **3.4 Condition of the Aircraft**

As described in 2.1.2 (1) and 2.7.3, regarding the flight control system and such of the Aircraft, no anomaly was observed. Accordingly, it is probable that the Aircraft had flown in a normal condition until this accident occurred.

### **3.5 History of the Flight**

#### **3.5.1 Pre-Flight Inspection (Operational Check)**

As described in 2.1.2 (1), the Captain did not perform the operational check of lights before this flight, though he expected that the Aircraft would fly at night during the latter half of the flight. It is probable that this was because the Captain did not know there were the dimmers on the right subpanel and believed that the internal lights could be automatically illuminated just by operating the light switches on the left subpanel.

It is somewhat likely that the Captain could illuminate the instrument lights and other internal lights just by operating the light switches in his past night flight before the accident. That is because the dimmers might not have been turned down to the off position at those times. However, as described in 2.8.4 (2), the dimmers had been all turned counterclockwise down to the off position at the time of the accident. The internal lights therefore were not illuminated just by operating the light switches in the left panel. It was not possible to determine how the dimmers had come to be turned down to the off position.

#### **3.5.2 Instrument Lights during the Flight**

Given the history of the Aircraft's flight as described in 2.1.1 and the time of the sunset on that day as described in 2.6.2, it is probable that the Aircraft was flying around Miyazaki Airport at the time of the sunset, and that the Captain tried to operate the panel switch on the left subpanel to illuminate the instrument lights at around this point. As described in 3.5.1, however, the Aircraft's instrument lights were not be illuminated just by operating the panel switches. It is probable that, at this time, the Captain was convinced that the instrument lights could no longer be illuminated because he caused an electrical failure by pressing "GYRO WARN" annunciator, which had been popped out from its mounted position before departure, consequently the Captain did not try to operate any other switches or knobs to illuminate the instrument lights. As described in 2.7.3, no anomaly was observed in the electrical system in the post-accident investigation.

As stated above, though the Aircraft's instrument lights remained not illuminated, as described in 3.6.2, it is probable that the Captain continued his flight to the Airport as

planned without heading for the nearest airport as the revised destination.

### **3.5.3 To the Downwind Leg after Commencing Approach**

As described in 2.1.2 (1), the Captain asked that he extended the landing gear and set the flaps to the approach position on the way to the downwind leg from South Point. It is therefore probable that the Captain configured these around the positions which were shown in Figure 1.

As described in his statement, it is probable that the Captain intended to enter the downwind leg at an altitude of about 1,500 ft. However, as shown in Figure 1, the Aircraft's altitude, which shown about 1,800 ft near South Point, was increasing little by little and climbing to about 2,100 ft at 18:24:33. It is somewhat likely that this gradual increment of the Aircraft's altitude was caused by the Captain's unintentional pulling of the control wheel, not only because he would not afford to check the altimeter using the Waterproof Portable Light, but also because he wanted to confirm the position of the Runway at this time.

### **3.5.4 Request to extend the Downwind**

As described in 2.1.1, at 18:24:37, the Captain said to the Tower, "Excuse me, but I have not confirmed yet and I will fly a bit further away. Is that OK?" As described in the statement, it is probable that the Captain at this time wanted to extend the downwind leg in order to confirm the position of the Runway exactly. An example of estimated flight route imaged by the Captain at that time is shown by the broken line in Figure 1.

Meanwhile, the Captain's report at this time did not specify what he could not confirm exactly, the Tower therefore interpreted that the Captain could not confirm the preceding aircraft. This is why the Tower reported the position of the preceding aircraft to the Captain and asked whether the Captain had the preceding aircraft in sight. However, it is probable that the Captain, who was expecting to receive the authorization of extending the downwind leg, did not reply to the Tower's question.

Then, at 18:24:54, the ATC instructed the Captain to report on the base leg. As described in the Captain's statement, at this time, he turned his attention toward the Airport again and could clearly confirm the position of the Runway. Therefore, it is probable that the Captain thought that he did not need to extend the downwind leg any more, and he could directly proceed to the base leg. Though the Aircraft was flying at an altitude of about 2,300ft at this time, it is probable that the Captain did not read his altimeter at that moment.

### **3.5.5 Base Leg**

As described in 2.1.1, the Tower issued landing clearance to the Aircraft at 18:25:20. It is probable that the Captain turned his attention to the Runway and see it again because he got the clearance to land. Then, it is probable that the Captain, as judging from the Runway overview, knew about that it was too high in a position for the Aircraft to land on the Runway with descending at standard rate.

As shown in Figure 1, it is probable that the Aircraft started to descend at around 18:25:27 when an altitude of about 2,350 ft was recorded, however, it descended and reached about 350 ft by 18:26:27. It is probable that the Aircraft dived by about 2,000 ft in about one minute in the base leg. Accordingly it was probable that the Aircraft made a steep descent equivalent to an average descent angle of about 10°.

### **3.5.6 Final Approach**

As described in 2.1.2 (1), the Captain stated that PAPI showed two whites and two reds when the Aircraft entered the final approach, it is therefore probable that the Aircraft was flying at the proper altitude at this time.

Regarding the Aircraft's flap position when it landed, the Captain stated that he could not remember whether he set the flaps from the approach position to the down position during the final approach. Thus it was not possible to clarify whether there had been any change from the approach position. Regarding the Aircraft's airspeed when it landed, the Captain stated that he did not read the airspeed indicator after he checked the airspeed of 100 kt at an altitude of about 300 ft. Partly because of this reason, it was also not possible to determine the airspeed when the Aircraft landed.

Moreover, regarding the landing light, as described in 2.1.2 (1), because the Captain stated that he gave up turning the landing light on in fear that he might operate the wrong switch by mistake because the left side panel was dark, it is probable that the Captain allowed the Aircraft to land with no landing light.

### **3.5.7 Flare**

As described in 2.1.2 (1), the Captain stated that he raised the nose once or twice while reducing power around where the Aircraft was passing the runway threshold. It is probable that the Captain repeatedly raised the Aircraft's nose with reducing power as usual as described in 2.8.6 above, and that the Aircraft was gradually descending and approaching the runway surface. It is probable that the Aircraft touched down on the runway from the nose gear with a hard impact, without securing pitch-up attitude just when the Captain, judging the height from the runway surface, was about to start to raise its nose as the final flare maneuver before touchdown.



It is probable that the Aircraft touched down from the nose gear when the Captain intended to start to raise the nose just before touchdown because he did not well recognize the precaution for night landing as will be described in 3.6.3.

### **3.5.8 Coming to a Stop on the Runway**

It is probable that the Aircraft touched down from the nose gear without securing pitch-up attitude around the position just before Point A shown in Figure 2, and that the hard impact in landing broke the fork and tore the nose-gear tire down. After that, it is highly probable that the Aircraft bounced once as described in the Captain's statement, and that the Aircraft continually moved with shooting sparks caused by hard contact between the nose gear and the runway surface as described in the mechanic's statement in 2.1.2 (3). Finally, it is highly probable that the Aircraft came to a stop breaking down at the point of the left-side runway edge of about 900 m from the Runway threshold.

As described in 2.1.2 (1), it is probable that the Captain could not carry out any action at this moment due to the hard impact when it landed.

## **3.6 Night Flight**

### **3.6.1 Pre-Flight Preparation**

As described in 2.8.1, the Civil Aeronautics Act provides that a pilot in command shall not start an aircraft, unless he has confirmed that the aircraft has no problems for flight and the necessary preparation for air navigation has been completed. More specifically, the Ordinance for Enforcement of the Act provides that the pilot in command shall confirm the maintenance status of equipment installed in an aircraft, and conduct the inspection of the exterior of aircraft and other elemental inspection of aircraft. Moreover, as described in 2.8.2, the Aircraft Flight Manual clearly specified to inspect navigation lights and other external lights as the pre-flight inspection, and also described to inspect instrument lights and other internal lights whenever necessary. This flight included a night flight part, the internal lights therefore should have been inspected.

In light of above mentioned facts, it is probable that the Captain should have performed the operational check of all Aircraft's lights before departure of this flight, however, actually he did not do so.

Besides, the Textbook described in 2.9.1 states that "*Reviewing the way of handling of lighting equipment is significant especially for night flight.*" However, the Captain did not know about dimmers. Moreover, the Textbook also states that "*At least one reliable flashlight is the minimum standard equipment to carry on a night flight,*" but the Captain made a flight without preparing his own flashlight for night flight, but he used a Waterproof Portable Light instead of a flashlight.

Thus, it is probable that the Captain did not perform the pre-flight operational check of the lights based on laws and regulations and the flight manuals, that is, the Captain allowed the Aircraft to fly without completing preparations for night flight.

Operation of aircraft should be complied with laws and regulations and flight manuals, which was a prerequisite for securing aviation safety, and this should be properly and closely adhered.

### **3.6.2 Flying without Instrument Lights**

The Textbook in the preceding section states that “*More dependence must be placed on the flight instruments, particularly the altimeter and airspeed indicator.*” However, as described in 3.5.2, it became dark around the Aircraft with dusk approaching, and instrument lights came to be unlighted. Accordingly it is probable that all the instruments including these flight instruments fell into the unreadable state.

Nevertheless, as described in 2.1.2 (1), the Captain stated that he continued flying toward the Airport. That is because he presumed to be able to manage somehow since he was well familiar with the Airport. Thus, regarding the fact that the Captain continued flying toward the Airport even though the Aircraft’s instruments fell into the unreadable state due to no instrument lights, it is probable that the Captain had overconfidence in his proficiency to manage his situation because he was familiar with the landing at the Airport.

As described in 2.6.3, Tanegashima Airport and Miyazaki Airport, along with the Aircraft’s route, were both VMC during the relevant time being of this flight. Thus, at the moment when the Captain recognized that the Aircraft’s instrument lights did not work, it is probable that the Captain should have diverted to the nearest airport in order to land within a daytime frame before the sunset, placing the top-priority to safe operation of the aircraft.

### **3.6.3 Precaution for Night Landing**

The Textbook states that “*Due to limited lighting conditions at night, it is difficult to identify the reference on the ground or compare the sizes or locations of objects on the ground. Thus, distance might be deceptive at night.*” This is indicating that visual sense of distance have some difference in between daytime landing and night landing. On the other hand, as described in 2.9.2, the Captain claimed that he had never felt an uncomfortable difference between daytime landing and night landing in the point of perspective of the runway in the past experience. Thus, it is highly probable that the Captain believed that he could judge the sense of distance from the runway in the night in a similar way as in the daytime, that is, he could judge the height from the runway surface even at night.

It is probable that, as described in 2.7.1, the Runway had runway lights and runway

centerline lights placed but no runway touchdown zone lights. As described in 2.6.2, there was no moonlight at the Airport at the time of the accident, and as described in 3.5.6, the Captain allowed the Aircraft to land with no landing light. Under these situation described, it is probable that the perspective of the Runway surface at the moment of the accident was too dark for the Captain to judge the distance from the runway. Actually, the Captain stated that he felt it difficult to judge the height of the Aircraft from the Runway surface because of no landing light when it landed at this accident. As a result, it is probable that the Captain made a misjudgment about the height of the Aircraft from the Runway surface, and consequently, he was too lagged in raising the Aircraft's nose just before touchdown, and then the Aircraft touched down on the runway from the nose gear.

The Textbook also states that "*Flare and touchdown should be performed in the same manner as in day landings. At night, the judgment of height, speed, and sink rate are impaired by scarcity of observable objects in the landing area,*" thus, it indicates that pilots shall take care for the airspeed and the sink rate when aircraft land at night. However, it is probable that the Captain could not check the Aircraft's airspeed before flare because its instrument lights were not illuminated at the time of this accident. The flare maneuver might be performed in adapting to different situations, in which the operational timing and volume need to be adjusted according to such factors as the airspeed, the descent rate and the wind. It is therefore probable that the Captain's failure to confirm the Aircraft's airspeed before flare contributed to his lagged operation in raising the nose.

#### **3.6.4 Effectivity of Landing Light**

As described in 3.5.6, it is probable that the Aircraft landed with no landing light.

The Textbook explains about the effectivity of landing light for night landing and the timing of the flare maneuver from a different view when the runway surface is difficult to see. For the latter, it states as a precaution "*Every effort should be made while carrying out coordinated operation of pitch and power.*" This is indicating that careful operation and maneuvering is required when the aircraft lands at night without landing light.

As described in 2.9.2, however, the Captain had not thought that landing light were necessarily essential in his past night landing experience. In this landing, it is somewhat likely that if the Captain had made the landing with landing light, following the description of the Textbook and being aware of its effectivity for night landing, it might have partly helped him confirm the height of the Aircraft from the Runway surface and led him to a safe landing.

#### **3.6.5 Experience of Night Landing**

As described in 2.9.2, the Captain had made 33 night landing in the past, though his

most recent night landing experience was made about four years ago. As described in 2.8.6, it is probable that the Captain knew about the characteristic of this type of aircraft; the Aircraft has a specific pitch down tendency when reducing power. However, this landing occasion was the first night landing in a long while for the Captain. It is therefore somewhat likely that the Captain could not sufficiently recognize the horizon which came to be a good reference for determining pitch attitude, and also that he could not properly recognize the Aircraft's nose down attitude just before touchdown. Consequently, it is somewhat likely that this factor contributed to the fact that the Aircraft touched down on the runway from the nose gear without securing pitch-up attitude before touchdown.

In the case when pilots, like the Captain who have not experienced any night landing for a long time, try to make a night landing, it is desirable that they should first review the points to consider for night landing, and then they should ask a flying instructor or another equivalent pilots with abundant experience of night flight to fly with in practicing to make a night landing in advance, if possible.

### **3.7 Go Around**

As described in 2.1.2 (1), the Captain felt it difficult to judge the height of the Aircraft from the Runway surface when the Aircraft lands, however, he did not hesitate for making the Aircraft land, nor intend to go around.

Pilots should operate an aircraft with making sure for safety. If they feel any doubt about a safe landing, they shall not hesitate to go around.

## **4. CONCLUSIONS**

### **4.1 Findings**

- (1) The Captain did not perform the operational check of the lights before this flight. Since a night flight came on to the Aircraft at the latter half of the flight, the Captain tried to operate the panel switch. However, the dimmers had been all turned down to the off position and the instrument lights did not illuminate. Nevertheless, it is probable that the Captain continued his flight to the Airport as planned. (3.5.1, 3.5.2)\*<sup>20</sup>
- (2) During the approach to the Airport, the Aircraft's altitude was increasing little by little. The Captain initially requested to extend the downwind leg, however,

---

\*<sup>20</sup> The numbers given at the end of each paragraph in this section are the main section numbers for the relevant descriptions in "3 ANALYSIS."

reconsidered and directly proceeded for the base leg. It is probable that the Aircraft made a steep descent equivalent to an average descent angle of about 10° in the base leg. (3.5.3, 3.5.4, 3.5.5)

(3) It is probable that the Captain allowed the Aircraft to land with no landing light. It is probable that the Aircraft touched down on the runway from the nose gear with hard impact without securing pitch-up attitude. It is highly probable that the hard impact in landing broke the fork and tore the nose-gear tire down, and that finally the Aircraft came to a stop on the Runway. (3.5.6, 3.5.7, 3.5.8)

(4) It is probable that the Captain did not perform the pre-flight operational check of the lights based on laws and regulations, and the flight manuals, and he allowed the Aircraft to fly without completing preparations for night flight. Operation of aircraft should be complied with laws and regulations, and flight manuals, which was a prerequisite for securing aviation safety, and this should be properly and closely adhered. (3.6.1)

(5) Regarding the fact that the Captain continued flying toward the Airport even though the Aircraft's instruments fell into the unreadable state due to no instrument lights, it is probable that the Captain had overconfidence in his proficiency to manage his situation because he was familiar with the landing at the Airport. When the Captain recognized that the Aircraft's instrument lights did not work, it is probable that the Captain should have diverted to the nearest airport in order to land within a daytime frame before sunset, placing the top-priority to safe operation of the Aircraft. (3.6.2)

(6) It is highly probable that the Captain believed that he could judge the sense of distance from the runway in the night in a similar way as in the daytime. It is probable that the Runway surface at the moment of the accident was too dark for the Captain to judge the distance from the runway partly because of no landing light. As a result, it is probable that the Captain made a misjudgment about the height of the Aircraft from the Runway surface. Consequently, he was too lagged in raising the Aircraft's nose just before touchdown, and the Aircraft touched down on the runway from the nose gear. It is also probable that the Captain could not check the Aircraft's airspeed before flare because its instrument lights were not illuminated at the time of this accident. Thus, it is probable that this contributed to the Captain's lagged operation in raising the nose. (3.6.3)

(7) On this landing, it is somewhat likely that if the Captain had made the landing with landing light, being aware of its effectivity for night landing, it might have partly helped him confirm the height of the Aircraft from the Runway surface and led him to a safe landing. When pilots who have not experienced a night landing for

a long time would try to make a night landing, it is desirable that they should first review the points to consider for a night landing, and then they should ask a flying instructor and others to fly with practicing to make a night landing in advance, if possible. (3.6.4, 3.6.5)

- (8) Pilots should operate an aircraft with making sure for safety. If they feel any doubt about a safe landing, they shall not hesitate to go around. (3.7)

## **4.2 Probable Causes**

It is highly probable that this accident occurred, when the Aircraft made a night landing, it touched down hard on the runway from the nose gear without securing pitch-up attitude because the Captain's maneuver was too lagged in raising the nose just before touchdown. Consequently, it sustained damages to the airframe including the nose gear.

Regarding the Captain's lagged maneuver in raising nose just before touchdown, it is probable that it was because he had made a misjudgment about the height of the aircraft from the runway surface. Additionally, it is probable that the Captain could not check the airspeed of the Aircraft before making the flare because its instrument lights were not illuminated. It is probable that this also contributed to the Captain's lagged maneuver in raising the nose.

Figure 1: Estimated Flight Path on the Approach to Matsuyama Airport

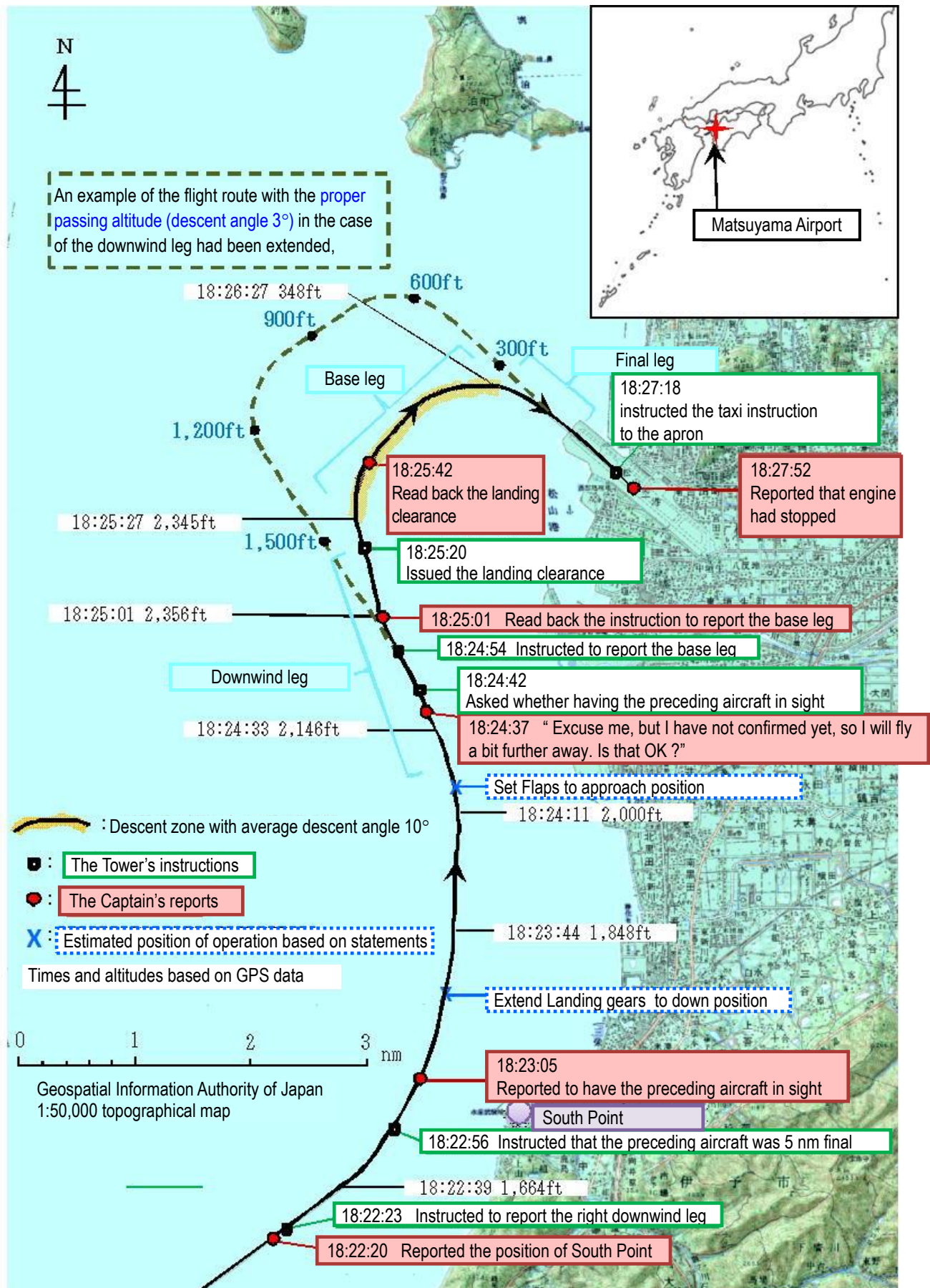
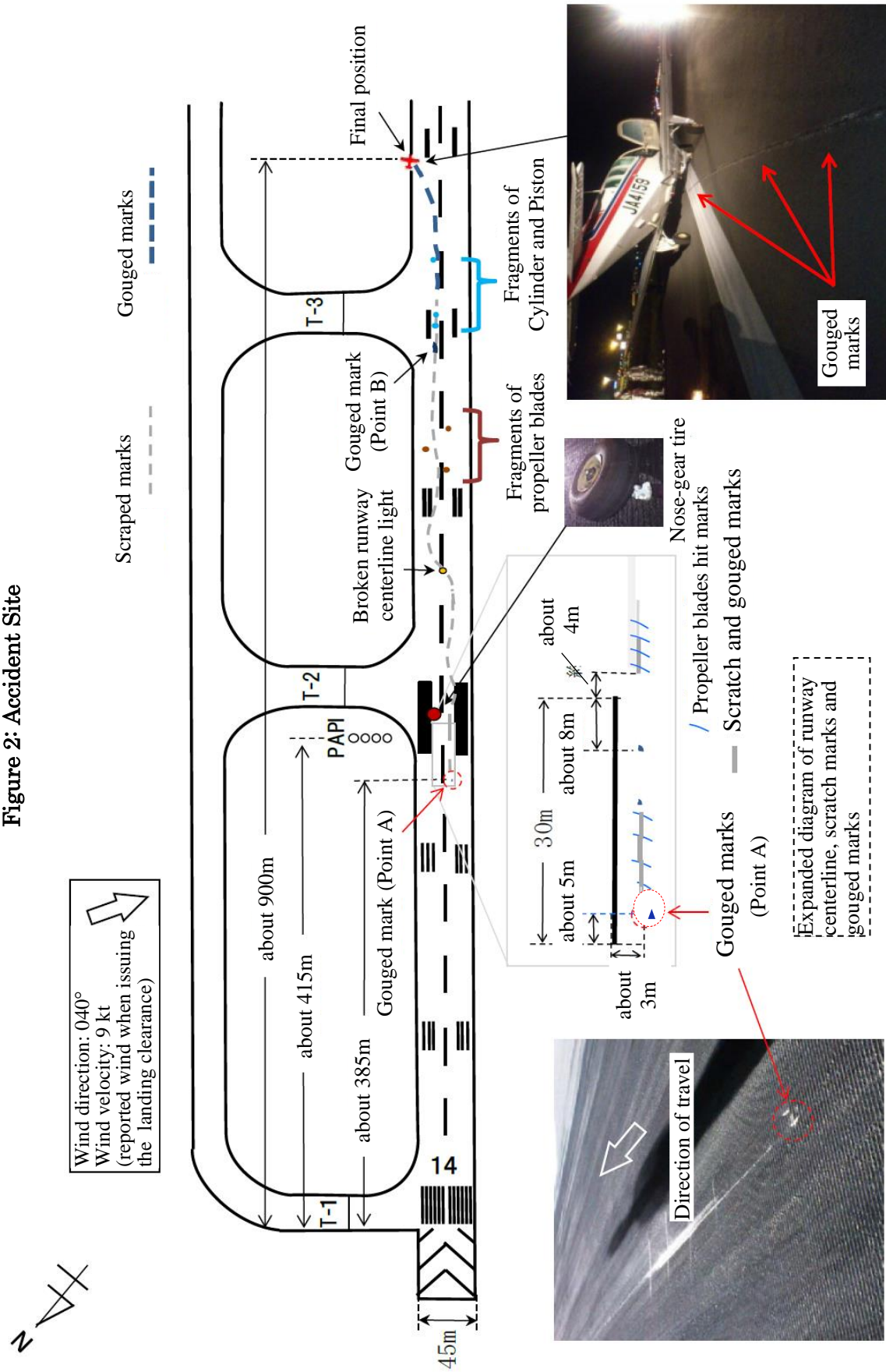

Figure 2: Accident Site



(Note) Not exact scale



Figure 3: Three Angle View of Beechcraft A36

Unit:m

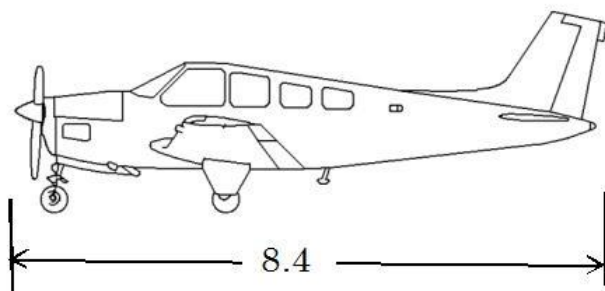
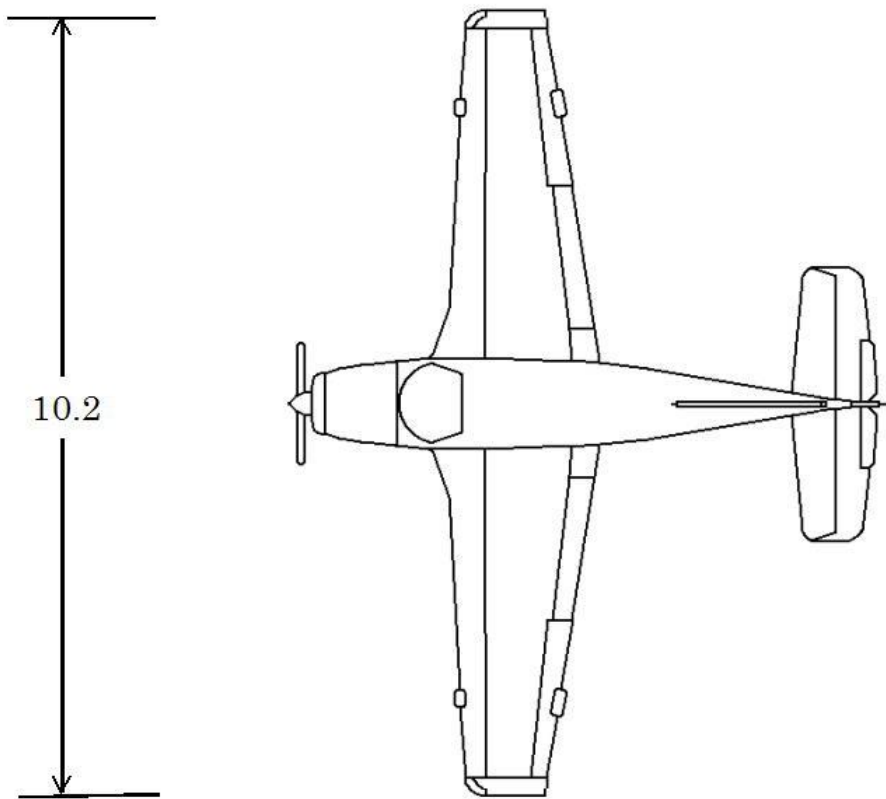
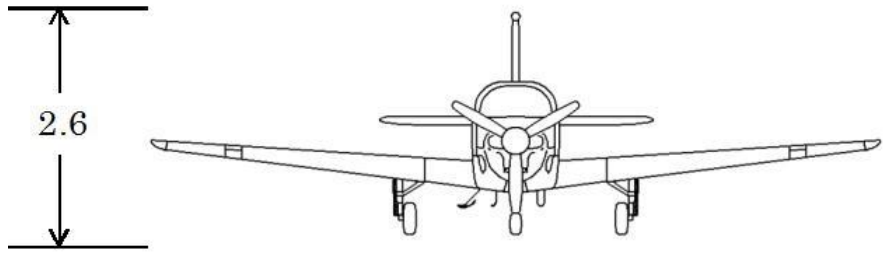

Photo 1: Accident Aircraft

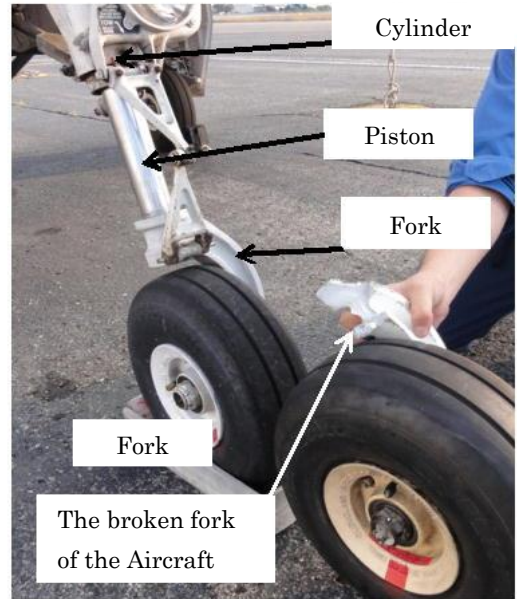

Photo 2: State of Damage to Various Parts



- Propeller blades (all three): Bent, partly broken
- Lower outer plate of engine left-side access panel: Wrinkled
- Taxi light: Not working
- Cylinder: Bottom broken

[ Piston had slotted into Cylinder ]



Nose gear structure of the type of the Aircraft and the Aircraft's nose-gear tire tore down



Wrinkling on lower outer plate in center of fuselage

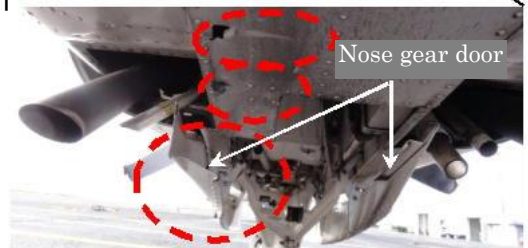

View towards nose gear from the center of fuselage

- Bending on nose gear door
- Penetration marks (holes)