

AA2017-4

**AIRCRAFT ACCIDENT  
INVESTIGATION REPORT**

**PRIVATELY OWNED  
JA 4060**

July 18, 2017

The objective of the investigation conducted by the Japan Transport Safety Board in accordance with the Act for Establishment of the Japan Transport Safety Board and with Annex 13 to the Convention on International Civil Aviation is to determine the causes of an accident and damage incidental to such an accident, thereby preventing future accidents and reducing damage. It is not the purpose of the investigation to apportion blame or liability.

Kazuhiro Nakahashi

Chairman

Japan Transport Safety Board

Note:

This report is a translation of the Japanese original investigation report. The text in Japanese shall prevail in the interpretation of the report.

# **AIRCRAFT ACCIDENT INVESTIGATION REPORT**

**CRASH AFTER TAKEOFF  
PRIVATELY OWNED  
PIPER PA-46-350P, JA4060  
CHOFU CITY, TOKYO METROPOLITAN, JAPAN  
AT AROUND 10:58 JST, JULY 26, 2015**

July 7, 2017

Adopted by the Japan Transport Safety Board

Chairman	Kazuhiro Nakahashi
Member	Toru Miyashita
Member	Toshiyuki Ishikawa
Member	Yuichi Marui
Member	Keiji Tanaka
Member	Miwa Nakanishi

## SYNOPSIS

### <Summary of the Accident>

On Sunday, July 26, 2015, at around 10:58 Japan Standard Time (JST: UTC + 9 hrs: unless otherwise stated, all times are indicated in JST using the 24-hour clock), a privately owned Piper PA-46-350P, registered JA4060, crashed into a private house at Fujimi Town in Chofu City, right after its takeoff from Runway 17 of Chofu Airport. There were five people on board, consisting of a captain and four passengers. The captain and one passenger died and three passengers were seriously injured. In addition, one resident died and two residents had minor injuries.

The aircraft was destroyed and a fire broke out. The house where the aircraft had crashed into were consumed in a fire and neighboring houses sustained damage due to the fire and other factors.

### <Probable Causes>

It is highly probable that this accident occurred as the speed of the Aircraft decreased during takeoff and climb, which led the Aircraft to stall and crashed into a residential area near Chofu Airport.

It is highly probable that decreased speed was caused by the weight of the Aircraft exceeding the maximum takeoff weight, takeoff at low speed, and continued excessive nose-up attitude.

As for the fact that the Captain made the flight with the weight of the Aircraft exceeding the maximum takeoff weight, it is not possible to determine whether or not the Captain was aware of the weight of the Aircraft exceeded the maximum takeoff weight prior to the flight of the accident because the Captain is dead. However, it is somewhat likely that the Captain had insufficient understanding of the risks of making flights under such situation and safety awareness of observing relevant laws and regulations.

It is somewhat likely that taking off at low speed occurred because the Captain decided to take a procedure to take off at such a speed; or because the Captain reacted and took off due to the approach of the Aircraft to the runway threshold.

It is somewhat likely that excessive nose-up attitude was continued in the state that nose-up tended to occur because the position of the C.G. of the Aircraft was close to the aft limit, or the Captain maintained the nose-up attitude as he prioritized climbing over speed.

Adding to these factors, exceeding maximum takeoff weight, takeoff at low speed

and continued excessive nose-up attitude, as the result of analysis using mathematical models, it is somewhat likely that the decreased speed was caused by the decreased engine power of the Aircraft; however, as there was no evidence of showing the engine malfunction, it was not possible to determine this.

### **< Recommendations >**

In this accident, small private aircraft crashed into a residential area and caused injury to residents as well as damages to houses, however the Aircraft was flying with exceeding the maximum takeoff weight and without satisfying the requirements for performance prescribed in the flight manual, and over the past five years, there have been two fatal accidents involving small private aircraft affected by inappropriate weight and position of the center of gravity of the aircraft ( (1) Mooney M20C, JA3788, which crashed when landing at Yao Airport in March 2016, and (2) Cessna 172N Ram, JA3814, which veered off the runway of Otone Airfield, Kawachi Town, Inashiki-gun, Ibaraki Prefecture, and made a fatal contact with a ground worker in August 2012). In view of the result of these accident investigations, as operation safety of small private aircraft needs to be improved, the Japan Transport Safety Board recommends the Minister of Land, Infrastructure Transport and Tourism pursuant to Article 26 of the Act for Establishment of the Japan Transport Safety Board to take the following measures:

(1) Promote pilots of small private aircraft to understand the importance to confirm that requirements for performance prescribed in the flight manual are satisfied, in addition to the importance to comply with maximum takeoff weight and limit for the position of the center of gravity, as confirmation before departure, at the occasions like specific pilot competency assessments and aviation safety seminars.

Enforce instructions and trainings to pilots of small private aircraft to plan the actions in advance including to follow the emergency procedure prescribed in the flight manual and confirm these actions thorough self-briefing by a pilot himself at the time of preparation before departure. along with compliance with the speed and procedure prescribed in the flight manual, as for the actions to the situation of degraded flight performance due to lack of acceleration or decrease in speed during takeoff.

(2) Study and compile the cases of effective measures connecting entrance taxiways to runway thresholds in order to make maximum use of runway length and inform aerodrome providers and administrators of these case studies as maximum use of runway length at takeoff, will allow a pilot to have a margin to make a decision during takeoff roll and contribute to improving safety.

Abbreviations used in this report are as follow:

AEIS:	Aeronautical En-route Information Service
AIP:	Aeronautical Information Publication
ALT:	altitude
AOA:	Angle of Attack
ASI:	Air Safety Investigator
ATSB:	Australian Transport Safety Bureau
BLWR:	Blower
CAA:	Civil Aviation Authority
CAS:	Calibrated Air Speed
CHT:	Cylinder Head Temperature
COND:	condition
DME:	Distance Measuring Equipment
deg:	degree
EAS:	Equivalent Air Speed
EMERG:	emergency
FAA:	Federal Aviation Administration
FAR:	Federal Aviation Regulations
fpm:	feet per minutes
ft:	feet
gal:	gallon
GPH:	Gallons Per Hour
GS:	Ground Speed
HP:	Horse Power
Hz:	Hertz
IAS:	Indicated Air Speed
ILS:	Instrument Landing System
IMG:	image
in:	inch
JAX:	Japan Aerospace Exploration Agency
JST:	Japan Standard Time
kt:	knot
KTS:	knots
lb:	pound
MAX:	Maximum
NTSB:	National Transportation Safety Board

POH:	Pilot's Operating Handbook
PSI:	Pounds per Square Inch
RNAV:	Area Navigation
RPM:	Revolutions/Rotations Per Minute
RWY:	Runway
SMS:	Safety Management System
STC:	Supplemental Type Certificate
TAS:	True Air Speed
TC:	Type Certification
TCA:	Terminal Control Area
TIT:	Turbine Inlet Temperature
VFR:	Visual Flight Rules
VHF:	Very High Frequency
VOR:	VHF Omni-directional radio Range
VRB:	variable
Vs:	Stall Speed
Vx:	best angle of climb speed
Vy:	best rate of climb speed
WDI:	Wind Direction Indicator

#### Unit Conversion Table

1 ft:	0.3048 m
1 in:	25.40 mm
1 nm:	1,852 m
1 lb:	0.4526 kg
[°C]:	$([°F] - 32) \times 5/9$
1 US gal:	3.785 ℓ
1kt:	1.852 km/h (0.514 m/s)
1 inHg:	3,386 Pa
1 HP:	0.746 Kw

# TABLE OF CONTENT

1.	PROCESS AND PROGRESS OF THE ACCIDENT INVESTIGATION .....	1
1.1	Summary of the Accident .....	1
1.2	Outline of the Accident Investigation.....	1
1.2.1	Investigation Organization.....	1
1.2.2	Representatives of the Relevant State.....	1
1.2.3	Implementation of the Investigation.....	1
1.2.4	Comments from the Parties Relevant to the Cause of the Accident .... .....	2
1.2.5	Comments from the Relevant State.....	2
2.	FACTUAL INFORMATION .....	2
2.1	History of the Flight .....	2
2.1.1	History of the Flight based on Video Images and Photo Images Taken in the Cabin of the Aircraft.....	3
2.1.2	Statements of passengers and eyewitnesses.....	4
2.2	Injuries to Persons .....	8
2.3	Damage to the Aircraft .....	8
2.3.1	Extent of Damage .....	8
2.3.2	Damage to the Aircraft Components.....	8
2.4	Situation of Accident Site and Other Damage .....	8
2.4.1	Situation of Accident Site .....	8
2.4.2	Other Damage.....	11
2.5	Personnel Information .....	14
2.6	Aircraft Information .....	14
2.6.1	Aircraft.....	14



2.6.2	Engine and Propeller .....	15
2.6.3	Maintenance Records .....	15
2.6.4	Weight and Balance.....	16
2.6.5	Fuel and Lubricating Oil.....	19
2.7	Outline of Piper PA-46-350P .....	19
2.7.1	Outline .....	19
2.7.2	Function of Each System.....	22
2.7.3	Characteristics of PA-46-350P .....	23
2.8	Confirmation of Weight and Position of the C.G.....	24
2.8.1	“Confirmation before Departure by Pilot in Command” Stipulated in Civil Aeronautic Act.....	24
2.8.2	Importance of Confirmation and Influence on Flight Performance of Weight and the Position of the C.G. ....	25
2.9	Meteorological Information .....	27
2.9.1	General Weather Forecasts.....	27
2.9.2	Aeronautical Weather Observation at the Airport .....	28
2.9.3	Temperature on the Runway.....	28
2.10	Aerodrome Information.....	29
2.11	Details of Damage .....	32
2.12	Medical Information .....	33
2.13	Information on Fire, and Fire-fighting and Rescue Operations.....	33
2.13.1	Information of Fire and Fire-fighting Operation .....	33
2.13.2	Information on Rescue Operation .....	33
2.14	Descriptions in Flight Manual of the Aircraft .....	33
2.14.1	<i>SECTION 2 LIMITATIONS</i> (Excerpts) .....	33
2.14.2	<i>SECTION 3 EMERGENCY PROCEDURES</i> (Excerpts) .....	37
2.14.3	<i>SECTION 4 NORMAL PROCEDURES</i> (Excerpts) .....	38

2.14.4	<i>SECTION 5 PERFORMANCE</i> (Excerpts) .....	46
2.14.5	<i>SECTION 6 WEIGHT AND BALANCE</i> (Excerpts) .....	48
2.15	Descriptions from the Maintenance Manual and Other Documents for PA-46-350P .....	51
2.15.1	TIO-510-AE2A Operator's Manual by the Engine Manufacturer .....	51
2.15.2	Propeller Owner's Manual (Manual No. 115N) by the Propeller Manufacturer .....	52
2.16	Tests and Verifications Information .....	52
2.16.1	Teardown Inspection of the Engine.....	53
2.16.2	Teardown Inspection of the Propeller .....	53
2.16.3	Teardown Inspection of the Magnetos .....	53
2.16.4	Teardown Inspection of the Air Conditioner.....	53
2.16.5	Verification of the Flight Route based on Images.....	54
2.16.5.1	The obtained visual materials.....	54
2.16.5.2	Speed during the takeoff roll.....	57
2.16.5.3	The changes of speed and height after the takeoff .....	58
2.16.5.4	Estimated flight route .....	60
2.16.5.5	Sound analysis during the before-takeoff check .....	61
2.16.5.6	Sound analysis during the flight.....	61
2.16.5.7	Readings of the instrument panel in the images taken in the cabin of the Aircraft .....	62
2.16.6	Analysis of the Past Flight .....	64
2.17	Information concerning the Operating and Maintenance Condition of the Aircraft .....	65
2.18	Additional Information.....	66
2.18.1	Takeoff Ground Roll Distance and Takeoff Distance in Calculation ... ..	66
2.18.2	Regulations concerning Takeoff Weight .....	66

2.18.3	Statements concerning the Captain.....	69
2.18.4	Premature Nose-up at the Time of Takeoff.....	70
2.18.5	Flying on the “Backside” .....	71
2.18.6	Safety Measures upon Landing and Takeoff of Aircraft at the Airport Facilities .....	73
2.18.7	Status of the Maintenance Management of the Aircraft .....	77
2.18.8	Status of Implementation of the Airworthiness Directive.....	77
2.18.9	International Standards, Oversea Regulations and Reference Cases . .....	77
2.18.10	Actions Taken by the Civil Aviation Bureau (Japan) after the Accident .....	83
2.18.11	Actions Taken by the Aerodrome Provider and Administrator (Tokyo Metropolitan Government) after the Accident .....	84
3.	ANALYSIS.....	86
3.1	Qualifications of Personnel.....	86
3.2	Airworthiness Certificate of the Aircraft .....	86
3.3	Takeoff Weight and Balance of the Aircraft.....	86
3.3.1	Confirmation of Weight and the position of C.G. before Departure..... .....	86
3.3.2	The Captain’s Recognition about Takeoff Weight .....	87
3.3.3	Effects of Weight and Balance of the Aircraft.....	87
3.3.4	Deviation from Allowable Ranges for Weight and the Position of the C.G.. .....	87
3.4	Flight of the Aircraft at the Time of the Accident.....	88
3.4.1	Configuration of the Aircraft and Weather Conditions at the Time of the Accident.....	89

3.4.2	Comparison of Flight profiles of the Aircraft between at the Time of the Accident and based on flight manual .....	89
3.4.3	Takeoff Roll and Takeoff (10:57:13-10:57:41) .....	90
3.4.4	Speed at the Time of Takeoff.....	91
3.4.5	State of Climbing just after Takeoff (10:57:42-10:57:54).....	91
3.4.6	Risks of Takeoff Slower than Lift-off Speed.....	92
3.4.7	Situation following climb immediately after Takeoff (10:57:55-10:58:00) .....	93
3.4.8	Situation from Height Reduction to Crash (from 10:58:00) .....	93
3.5	Analysis based on Mathematical Model.....	95
3.5.1	Conditions at the Time of the Accident.....	95
3.5.2	Mathematical Model of the Aircraft.....	96
3.5.3	Comparison at Takeoff Ground Rolls.....	97
3.5.4	Simulation at Takeoff and Climb.....	99
3.5.5	Flight during Shallow Descent.....	101
3.6	Analysis on Engine Power of the Aircraft .....	102
3.6.1	Decreased Engine Power due to Flying Operation .....	102
3.6.2	Influence of Outside Air Temperature .....	103
3.6.3	Possibility of Decreased Engine Power Due to Other Factors.....	103
3.6.4	Verification Result of Engine Power .....	106
3.6.5	Relation between Decrease of Engine Power and RPM.....	106
3.6.6	Constant Decrease of Value Indicated on TIT Indicator .....	107
3.7	Preparation for Partial Power Loss of an Engine .....	108
3.8	Response of the Civil Aviation Bureau of the Ministry of Land, Infrastructure, Transport and Tourism .....	108
3.9	Response of the Provider and Administrator of Chofu Airport (Tokyo Metropolitan Government) .....	109
3.10	Improvement of Safety .....	110

3.10.1	Ensuring Safety of Small Private Aircraft.....	110
3.10.2	Improvement of Safety at Airports .....	111
3.10.3	Measures for Increasing Safety in Small Private Aircraft Maintenance .....	112
4.	CONCLUSION .....	112
4.1	Findings .....	112
4.2	Probable Causes.....	116
5.	SAFETY ACTIONS .....	117
5.1	Safety Actions Taken after the Accident.....	117
5.1.1	Safety Actions Taken by the Civil Aviation Bureau of the Ministry of Land, Infrastructure, Transport and Tourism .....	117
5.1.2	Safety Actions Taken by the Provider and administrator of Chofu Airport (Tokyo Metropolitan Government).....	119
5.2	Safety Actions Required by the Civil Aviation Bureau of the Ministry of Land, Infrastructure, Transport and Tourism.....	120
6.	RECOMMENDATIONS .....	121
Figure 1	Three View Drawings of Piper PA-46-350P .....	123
Figure 2	Seating Chart .....	124
Attachment 1-1	Photos taken from inside of the Aircraft (Right Wing and Flaps) (i) .....	125
Attachment 1-2	Photos taken from inside of the Aircraft (Right Wing and Flaps) (ii) .....	126
Attachment 2	Inside of the Aircraft (instrument panel) .....	127

Attachment 3-1	Performance Chart (Takeoff Ground Roll Distance — 0° Flaps) ....	128
Attachment 3-2	Performance Chart (Takeoff Distance — 0° Flaps) .....	129
Attachment 3-3	Performance Chart (Short Field Takeoff — Takeoff Ground Roll Distance)	130
Attachment 3-4	Performance Chart (Short Field Takeoff — Takeoff Distance)	131
Attachment 4	Wind data Around the Time of the Accident .....	132
Attachment 5	Flight Test Record (Extract) .....	133
Attachment 6	Teardown Inspections of Engine, Propeller and Others.....	134

# 1. PROCESS AND PROGRESS OF THE ACCIDENT INVESTIGATION

## 1.1 Summary of the Accident

On Sunday, July 26, 2015 at around 10:58 Japan Standard Time (JST: UTC + 9 hrs: unless otherwise stated, all times are indicated in JST using the 24-hour clock), a privately owned Piper PA-64-350P, registered JA4060, crashed into a private house at Fujimi Town in Chofu City, right after its takeoff from Runway 17 of Chofu Airport

There were five people on board, consisting of the captain and four passengers. The captain and one passenger died and three passengers were seriously injured. In addition, one resident died and two residents had minor injuries.

The aircraft was destroyed and a fire broke out. Furthermore, the house where the Aircraft crashed into were consumed in a fire, and neighboring houses sustained damage due to the fire and other factors.

## 1.2 Outline of the Accident Investigation

### 1.2.1 Investigation Organization

(1) On July 26, 2015, the Japan Transport Safety Board (JTSB) designated an investigator-in-charge and two other investigators to investigate this accident. JTSTB designated six more investigators on September 26, 2016.

(2) An expert advisor was appointed for the investigation of the following technical matters with respect to this accident.

For investigation into flight analysis

The Japan Aerospace Exploration Agency

Aeronautical Technology Directorate

Flight Research Unit

Kouhei Funabiki

(Appointed on April 18, 2016)

### 1.2.2 Representatives of the Relevant State

An accredited representative of the United States of America, as the State of Design and Manufacturer involved in this accident, participated in the investigation.

### 1.2.3 Implementation of the Investigation

July 26, 2015: On-Site investigation and aircraft examination

July 27, 2015: Aircraft examination, on-site investigation and interviews

July 28, 2015: Aircraft examination, document inspection and interviews

July 29, 2015: Aircraft examination and interviews  
 August 3, 2015: Interviews and aircraft examination  
 January 12 to 13, 2016: Teardown inspections on the engine and propellers  
 (at the engine Manufacturer’s factory)  
 April 18, 2016 to January 5, 2017: Flight analysis  
 October 7, 2016: Flight test using the type of aircraft  
 December 13 to 14, 2016: Progress meeting with the relevant state concerning  
 the flight analysis and failure mode (held at the  
 Aircraft manufacturer’s factory)

#### 1.2.4 Comments from the Parties Relevant to the Cause of the Accident

Comments were not invited from the parties relevant to the cause of the accident due to the death of the captain.

#### 1.2.5 Comments from the Relevant State

Comments on the draft report were invited from the relevant state.

## 2. FACTUAL INFORMATION

### 2.1 History of the Flight

On July 26, 2015, a privately owned Piper PA-46-350P (hereinafter referred to as “the Aircraft”), registered JA4060, took off from Chofu Airport (hereinafter referred to as “the Airport”), with the pilot sitting in the left pilot seat and four passengers being on board the cabin (see Appended Figure 2 Seat Arrangement Diagram).

The flight plan of the Aircraft is outlined below:

Flight rules:	Visual flight rules
Departure aerodrome:	Chofu Airport
Estimated off-block time:	10:45
Cruising speed:	140 kt
Cruising altitude:	VFR
Route:	Yokosuka
Destination aerodrome:	Oshima Airport
Total estimated elapsed time:	1 hour 00 minute
Fuel load expressed in endurance:	5 hours 00 minute
Persons on board:	5 persons



Purpose of the flight:

Other\*<sup>1</sup>

The history of the flight up to the accident is summarized as below, according to the multiple images that were taken around Chofu Airport (video images and pictures taken in the cabin of the Aircraft), the statements of a passenger who sat in the left seat of the rear row (hereinafter, referred to as “Passenger A”), a passenger who sat in the right seat of the rear row (hereinafter, referred to as “Passenger B”), a passenger who sat in the right seat of the middle row (hereinafter, referred to as “Passenger C”), Chofu Flight Service personnel in charge of communication, and the eyewitnesses.

### 2.1.1 History of the Flight based on Video Images and Photo Images Taken in the Cabin of the Aircraft

On the day of the accident, multiple images that were taken around the Airport contained records of the flight situation of the Aircraft. Using these images, the verified flight history is outlined below.

Around 10:50	The Aircraft had a preflight check at Spot 20N.
Around 10:54	Started taxiing for departure.
Approximately 10:57:12	Started a takeoff roll from near the threshold of Runway 17.
10:57:35	Passed through the point 400 m from the threshold of and at the center of Runway 17 with a speed of approximately 59 kt. Around this point, fluctuations on pitch were observed.
10:57:38	Nose gear showed movements of lift off the ground at a speed of approximately 65 kt at the point approximately 500 m from the threshold of Runway 17.
10:57:41	The Aircraft took off at the point approximately 630 m from the threshold of Runway 17 with a speed of approximately 73 kt. The Aircraft continued to slowly veer to left from about the time of takeoff.
10:57:52	Retracted the landing gear at a ground altitude (hereinafter referred to as “height”) about 70 to 80 ft. The aircraft was nose-up attitude and the climbing angle was approximately 4°.
10:57:55	Reached a height approximately 90 ft with a speed of approximately 67 kt, then transferred from climbing to descending slowly. However, the attitude of the Aircraft remained a nose-up.

---

\*<sup>1</sup> “Other” means a flight other than air transport service and aerial work service and does not fall under a flight for test, air transportation and official use.

- 10:57:55 to 58:00 Along with repeating nose-up and pitch-down three times during a slow descent, the speed decreased to approximately 62 kt with fluctuation of speed.
- 10:58:00 At a height approximately 84 ft, the Aircraft banked to left and started to descend like sliding to lower-left. At this time, the speed was approximately 62 kt and pitch was still nose-up attitude.
- 10:58:07 Crashed into a private house in Chofu City.

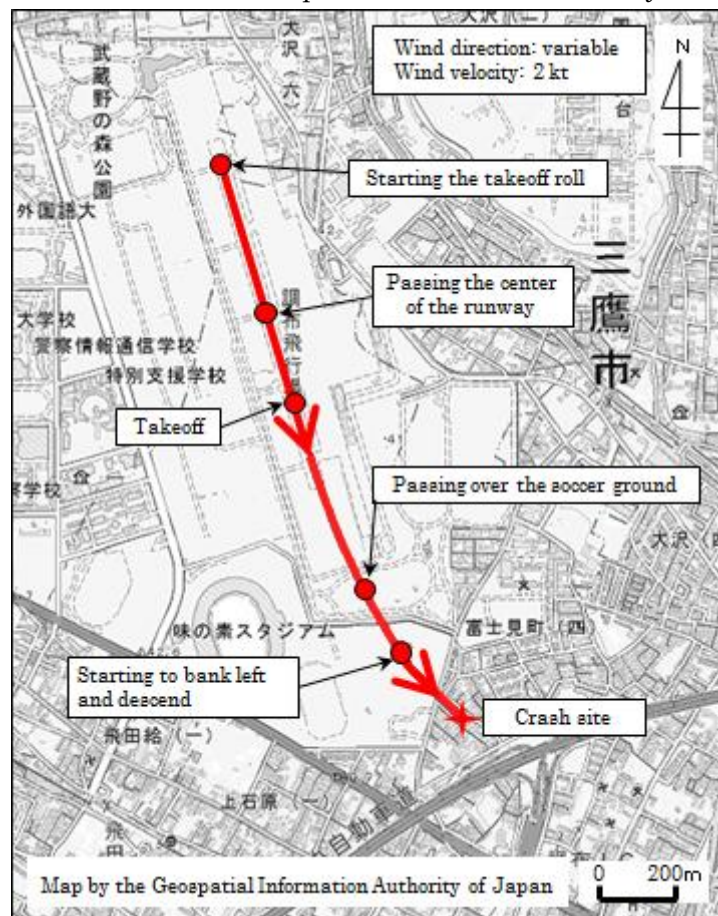

Figure 2.1.1 Estimated Flight Route

## 2.1.2 Statements of passengers and eyewitnesses

### (1) Passenger A

Passenger A planned the flight to Oshima and invited his acquaintances. A test-run of the engine was conducted in the apron. The air-condition system was switched on after the engine started. The takeoff was a standing takeoff, which the Aircraft stopped once on the runway and started the roll after increasing engine rpm to full. Passenger A did not feel any anomalies during the takeoff roll. At the time of the

takeoff, a sequence of the turn to lift the gear was the nose gear first, and then the main landing gear.

After the takeoff, Passenger A thought that the wind was strong as the plane was swaying from side to side. He was thinking the Aircraft climbed so slow for a powerful Malibu, but did not feel strange as the climb was also slow and gradual in his past flights on a Cessna.

After that, he did not feel any danger even though the plane was unstable and swaying from side to side because he thought the swaying was caused by strong wind. The Captain did not seem to be panicking. He thought that the Captain was making a left turn in order to pass through a checkpoint. He felt bad when he heard a sound like a stall warning sound.

Passenger A did not remember the contact with private houses or the details of the crash. He did not even prepare for anything because nobody told him any danger and he himself did not feel anything dangerous. He did not know how long he had lost consciousness, but when he became aware of the situation, he was upside down and hanging by his seatbelt in the upside-down Aircraft. Somebody called out, "Fire". It was difficult to unfasten his seatbelt, but somehow he managed to unfasten it and crawl out from the plane. It was very hot around him, and he could see roofing tiles beside him. He could not move and was lying down there for a while. He saw other passengers fall down.

(2) Passenger B

Passenger B was on board as Passenger A, who was his acquaintance, invited him to hire a small airplane and enjoy flying. Passenger B felt that Passenger A often invites his acquaintances for flights from the way he spoke.

Passenger C and the passenger who died (hereinafter referred to as "Passenger D") were friends of Passenger B from school days. After receiving the invitation by Passenger A, three of them were tempted to go somewhere by hired small airplane. Flying to Oshima was Passenger A's suggestion and because their purpose was to fly on a small airplane and they thought agreed without caring about the destination.

Passenger B thinks that he did tell his name and date of birth in advance, but he did not remember that Passenger A or the Captain asked him about his weight or other information.

In the Aircraft, Passenger B took the right seat of the rear row. The Captain sat in the left pilot seat, Passenger C sat in the right seat of the middle row and Passenger D in the left seat of the middle row. Passenger A sat in the left seat of the rear row. Everybody took their seats without thought or instruction. All personnel on board

fastened seatbelts. Nobody sat in the right pilot seat. Passenger B thought that the Captain made a warm up engine and other operation from the time being on board to the departure. After the takeoff or after the start of the engine, cold air flowed out of the air-conditioning system.

After the takeoff, a change in attitude occurred right away. The Aircraft rolled to the right or left right after the takeoff, and while Passenger B was wondering whether it was OK, it rolled to the opposite side and crashed in just a second. There was a terrible collision sound. He lost consciousness for a while due to the strong impact because of the crash. He did not know for how long he had lost consciousness, but he woke up because of strong pain in his abdomen.

When Passenger B returned to consciousness, he saw a fire. He did not know when the fire broke out. Passenger A escaped to the outside of the Aircraft first. Finding that Passenger C had been blown off with his chair, Passenger B escaped taking Passenger C with him. He looked for Passenger D, but could not find him. The place where they escaped was the second floor of a house.

A resident screamed "Fire!"

Passenger B stepped down to the ground holding onto a vehicle crashed beneath the plane. Thinking of the risk of an imminent explosion, he evacuated to a spot about 30 m in front of a house. Some residents poured water over him as he lay down on the ground. Passenger B did not hear any electronic "bii", "puu", or "pingpong" kind of sounds.

### (3) Passenger C

Prior to the flight, Passenger A replied to Passenger D, who asked about the weight, that the weight would be OK because maximum passenger of the Aircraft was six persons and there would be only five on board including the Captain. Up to the accident flight, Passenger C does not have any memory of Passenger A or the Captain asking him about his weight and other information.

In the Aircraft, Passenger C sat in the left seat of the middle row. Passenger D sat in the right seat of the middle row and Passenger A and Passenger B sat in the seats in the rear row. Everybody took their seats without thought or instruction.

The Captain was conducting before-takeoff check by calling out each item as he checked it. The Aircraft stopped once after entering the runway and then started to roll.

After the takeoff, he was surprised as the Aircraft descended suddenly. Passenger C felt that the Aircraft lost balance and the Captain was trying to recover the control while saying something. Passenger C has no memory of whether he heard

the buzzer sound or not at this time.

Passenger C remembered the shock of the crash but had no recollection of the following events. When he returned to consciousness, the Aircraft was crashed and he thought he had to escape promptly. Passenger C smelled the aviation fuel.

(4) Chofu Flight Service Personnel in charge of communications and others

The Captain was conducting the radio communication of the Aircraft. There were no specific anomalies during the takeoff roll, but the lift off seemed to be slightly delayed. After the takeoff, it took long time to gain height and the Aircraft veered to the left. After that, the personnel confirmed that a black smoke and a pillar of fire were rising up.

(5) Eyewitness A (a pilot of another aircraft who was going to takeoff following the Aircraft at the Airport)

Eyewitness A felt that the takeoff ground roll was long. After the takeoff, he thought that the Aircraft would crash because it could not gain height and if it stayed as it was. Then he saw that black smoke was rising and knew it crashed.

(6) Eyewitness B (a pilot who was preparing to depart from the apron of the Airport)

Eyewitness B saw there was no anomaly during the takeoff roll of the Aircraft. It gained little height after the takeoff. The engine sound was normal. However, as the Aircraft seemed panting while climbing, he noticed that something was wrong. It seemed that the Aircraft tried to climb but failed, and looked like it was “floating”. He thought that it might have been a situation like when flying at high altitude, engine would not respond to the throttle operation.

(7) Eyewitness C (a neighboring resident of the accident site)

When Eyewitness C was in the living room, she heard the sound of an aircraft, but it was not the sound she usually heard. Then, she heard a “bang” sound.

Eyewitness C heard the sound of an aircraft hitting a neighboring house, but did not feel shaking. She clearly knew that an aircraft crashed, and went to the window to look outside soon after she heard the sound.

Eyewitness C could not see the whole of the Aircraft, but could see a part of the empennage of the Aircraft. She did not feel anything hitting her house. Immediately, black smoke and an orange pillar of fire rose up from the direction of the Aircraft. She did not see anyone escape from the Aircraft. There was no fuel raining. She rushed to the main entrance and tried to open the door, but could not. She pushed the door with the weight of her full body, and could finally open it and ran out to escape. The hot blast of air was so severe that the planter of the morning glory had melted. On her way to escape, she heard a crackling sound like fire and an explosion many times.

(8) Eyewitness D (a neighboring resident of the accident site)

When Eyewitness D rushed to the site from the south side, neighbors were pouring water over the passengers who escaped from the Aircraft. The fire was strong. Those passengers suffered severe burns. Eyewitness D could hear a sound like a fire cracker from the site. Fire engines arrived immediately. The Aircraft was upside down and the wings were stuck out toward the street, but the empennage was standing slightly diagonally.

The accident occurred at around 10:58 on July 26, 2015, near Fujimi Town in Chofu City (N35°39'44", E139°39'1").

## **2.2 Injuries to Persons**

The Captain, one passenger and one resident were killed. Three passengers were seriously injured. Two residents suffered minor injuries.

## **2.3 Damage to the Aircraft**

### **2.3.1 Extent of Damage**

Destroyed.

### **2.3.2 Damage to the Aircraft Components**

- (1) Fuselage: Burned except a tail section
- (2) Wings: Left wing fractured and burned, right wing damaged
- (3) Engine: Burned
- (4) Propeller: Bent and burned
- (5) Landing Gear: Nose landing gear and main landing gear damaged

## **2.4 Situation of Accident Site and Other Damage**

### **2.4.1 Situation of Accident Site**

The accident site was in a residential area located about 770 m at 148 degree-direction (south south-east) from the threshold of Runway 35 at Chofu Airport. The private house with an antenna damaged by the Aircraft is referred to as "House A," the houses at south-east side from House A are referred to as "House B," "House C" and "House D" in order. In addition, the house adjacent to the north-east side of House D is referred to as "House E." (See Figure 2.4.1-1.)

The Aircraft crashed upside down with the nose to north and the empennage to south in the site of House D, which faces a 4 m-wide public road at the south-west side.

The fire that broke out from the Aircraft after the crash consumed and House D completely.

House E was partially burned due to the fire caused from the Aircraft. Other houses next to House D suffered damage due to the fire spread or radiant heat. Excluding the empennage, the fuselage of the Aircraft was almost all burned up without any original shapes. The right horizontal stabilizer was sticking out on the public road. A part of the burned main wings was found on the public road in front of House D and near the west-side wall of House D left unburned.

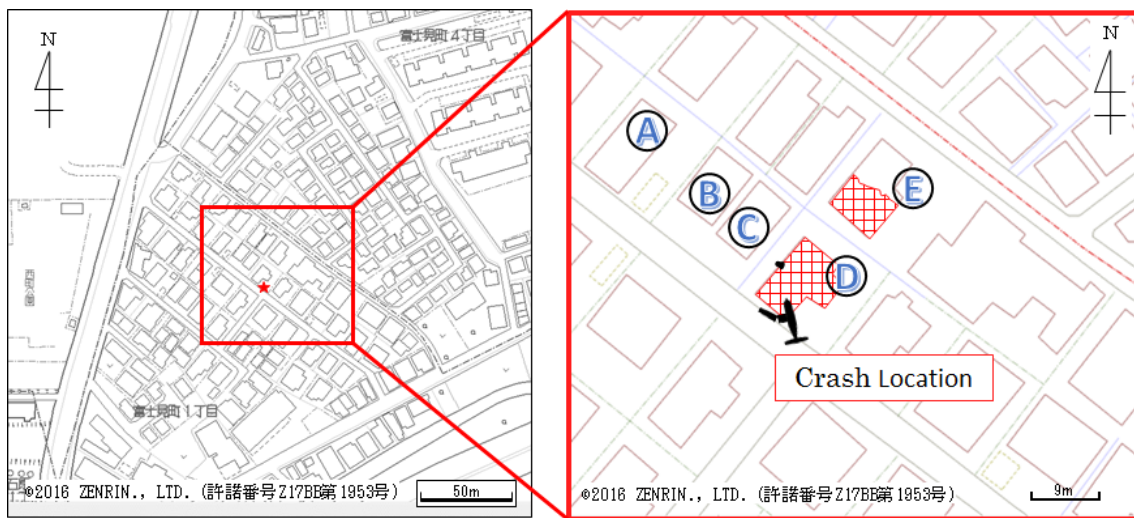

Figure 2.4.1-1 Area Map of Crash Site



Photo 2.4.1-1 Accident Site and the Aircraft (part 1)



Photo 2.4.1-2 Accident Site and the Aircraft (part 2)



#### 2.4.2 Other Damage

House D facing a public road at the south-side was a two-story house, but the south-side of the house was burned down almost completely, leaving only the west-side wall. For the other parts of the house, the roofs were lost to fire and only charred columns were standing. A vehicle and a motorcycle which had been parked in the garden of House D were consumed by the fire, being under the Aircraft. Houses C and E adjacent to House D, which was burned down completely, caught fire or suffered damage due to radiant heat with the level of damage varying.

On the rooftop of House A, about 6.5 m high above the ground, a TV antenna was collapsed together with the support column of about 3.8 m in length. The column was bent by about  $13^\circ$  at the point of mounting the antenna branch line at a height of about 2 m from the rooftop. A Yagi antenna for UHF installed at about 3 m high from the rooftop was bent downward by about  $75^\circ$ , a part of the antenna was detached and dropped onto the rooftop, and the antenna itself was off from the column and was hung by single cable line from the roof edge.

The roofing materials of House B from the side facing the public road were scattered onto the roof of nearby House C.



Photo 2.4.2-1 House A to House D



Photo 2.4.2-2 Collapsed TV Antenna of House A



Photo 2.4.2-3 Damaged Roof of House B and Roofing Materials Scattered on House C

There were the roofing materials from damaged House B scattered over the rooftop of House C, but there is no trace of contact with the Aircraft. Besides, the windows at the south east side of the first and second floors were broken and traces of burning were confirmed on the south side exterior wall. A vehicle and a bicycle parked in the garden were burned. House E had a closet on the first floor and the exterior wall and roof of the second floor damaged by the fire.

In addition, it was confirmed that the houses adjacent to House D had entrance doors and other parts burned in such as the fire, coatings for outdoor air conditioner units, ventilation fans and electrical wire covers melted and window glasses damaged and cracked.



Photo 2.4.2-4 Fire Damage of House C



Photo 2.4.2-5 Fire Damaged Vehicle  
of House C



Photo 2.4.2-6 Fire Damage of House E

## 2.5 Personnel Information

Captain	Male, Age 36	
Commercial pilot certificate (airplane)		August 16, 2006
Type rating for Single engine (land)		May 16, 2005
Multiple engine (land)		December 22, 2005
Specific pilot competence		March 31, 2014
Expiration date of piloting capable period		March 31, 2016
Instrument flight certificate (airplane)		May 10, 2006
Flight instructor certificate (airplane)		February 1, 2013
Class 1 aviation medical certificate		
Valid until		February 23, 2016
Total flight time		about 1,300 hours
Flight time in the last 30 days		about 19 hours
Total flight time on the type of aircraft		about 120 hours
Flight time in the last 30 days		0 hours 29 minutes

## 2.6 Aircraft Information

2.6.1 Aircraft		
Type		Piper PA-46-350P
Serial number		No. 4622011
Date of manufacture		February 14, 1989
Certificate of airworthiness		No. To-27-058
Valid until		May 1, 2016
Category of airworthiness		Airplane Normal N
Total flight time		2,284 hours 50 minutes
Flight time since the last periodical check (100-hour check on April 17, 2015)		23 hours 51 minutes

(See Figure 1 Three Angle View of Piper PA-46-350P)



Photo 2.6.1 The Aircraft (provided by the administrating office of the Airport)

## 2.6.2 Engine and Propeller

### (1) Engine

Type:	Lycoming TIO-540-AE2A
Serial Number:	RL-9350-61A
Date of manufacture:	March 22, 2003
Total flight time:	1,001 hours 32 minutes

### (2) Propeller

Type:	Hartzell HC-I2YR-1BF/F8074K
Serial Number:	HA 6
Date of manufacture:	June 6, 1988
Total flight time:	1,541 hours 01 minutes

## 2.6.3 Maintenance Records

During the time from April 8 to 17, 2015, the Aircraft received preparation work to take an inspection for the Airworthiness Certificate (renewal) and renewed the airworthiness certificate on May 1, 2015. There are no records of any periodic maintenance work after that date.

The records of past flight tests accompanying periodic maintenance work had items of Stall Speed, Stall Warning Speed, TIT and data of engine performance and so on. (See Annex 5: The Records of Flight Test (Excerpt))

(1) Airframe

As major maintenance work other than periodic maintenance work, repair work was conducted from January 24 to June 16, 2005, for damage in the airframe due to an accident which occurred on October 27, 2004. From June 23, 2008 to November 1, 2010, a 1000-hour check was implemented based on the maintenance manual.

(2) Engine

The engine of the Aircraft was replaced on June 18, 2004. Engine checks relating to a propeller strike were conducted in conjunction with the damage of the airframe due to the accident that occurred on October 27, 2004 was repaired. As another major check, the 400-hour check of the engine was implemented along with the 1,000-hour check of the airframe.

(3) Propeller

The propeller of the Aircraft was replaced on June 14, 2005, along with the repair works for the damage of the airframe due to the accident that occurred on October 27, 2004.

The maintenance records after the propeller replacement contain no statements about any adjustment of the low-pitch stop setting.

#### 2.6.4 Weight and Balance

Regarding the estimated takeoff weight of the Aircraft, the empty weight ( the latest records by the airworthiness certificate examination ), weight of five passengers, cloths and the like, belongings , onboard baggage (wheel stoppers, extra oil, mooring rope, rag, stepladder, fire extinguisher, life vest, bags, flight logbook, Emergency Locator Transmitter, first aid kit and the like), estimated amount of fuel, and amount of fuel consumed for ground test-run and taxiing were estimated as confirmed:

- |                                                     |                                                                                                                    |
|-----------------------------------------------------|--------------------------------------------------------------------------------------------------------------------|
| (1) Empty weight:                                   | Approximately 1,358 kg (approximately 2,994 lb)                                                                    |
| (2) Weight (Captain):                               | Approximately 58.5 kg (approximately 129.0 lb)                                                                     |
| (3) Weight (passengers):                            | Approximately 280 kg (approximately 617.3 lb) in total (based on the total of estimated weight of four passengers) |
| (4) Cloths and the like of the passengers on board: | Total: approximately 7 kg (approximately 15.4 lb)                                                                  |
| (5) Belongings of the passengers, onboard baggage:  | Approximately 27 kg (approximately 59.5 lb)                                                                        |



Table 2.6.4 The Weight and the Position of the C.G. of the Aircraft (at the time of the Accident)

	Weight (kg)	Weight (Lb)	Arm Aft Of Datum (Inches)	Moment (In.-Lb)
Basic Empty Weight	1,358	2,994	134.94	404,010
Pilot and Front Passenger	66.4	146.4	133.50	19,544
Passengers (Center Seats)	150.5	331.8	177.00	58,729
Passengers (Rear Seats)	134.5	296.5	218.75	64,859
Baggage (Forward)※	14.7	32.4	88.60	2,871
	6.8	15.0		1,329
Baggage (Aft) ※	6.8	15.0	248.23	3,723
	14.7	32.4		8,043
Fuel	286	630.5	150.31	94,770
Fuel Allowance for Taxi, & Runup	8.2	18	150.31	2,706
Total	2,008	4,427	146.00	645,800
			146.50	648,578

※ Regarding baggage in forward and aft compartments, two sets of estimated values are shown here.



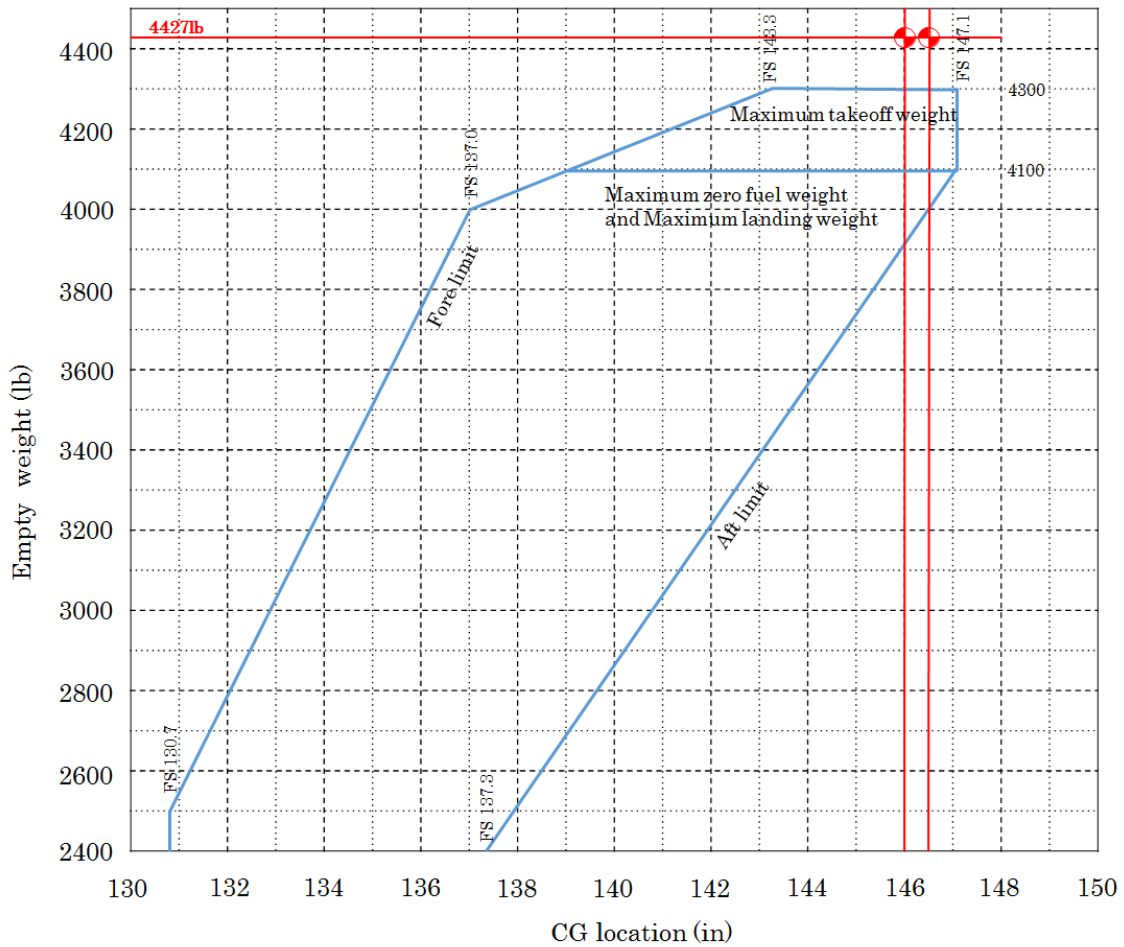

Figure 2.6.4 Weight and Balance of the Aircraft (at the time of the accident)

## 2.6.5 Fuel and Lubricating Oil

Fuel was aviation gasoline 100LL and lubricating oil was Phillips X/C MIL-L-22851.

## 2.7 Outline of Piper PA-46-350P

### 2.7.1 Outline

Piper PA-46-350P (hereinafter, referred to as “PA-46-350P”) is a single reciprocating engine aircraft manufactured by Piper. This engine is a horizontal opposed-6 cylinder type single reciprocating engine with a turbocharger and produces 350 HP as a maximum power. The propeller is all-metal and has variable pitch control with two 80-inch diameter blades. The Aircraft is all-metal, has retractable landing gear, and is low winged. It has a pressurized cabin with seating for six occupants (including the captain and co-pilot) and two baggage spaces with one in front and one at the back of the cabin. As main control system, it has aileron, elevator and rudder.

As characteristics of PA-46-350P, it has high cruising speed of 205 kt (380 km/h) for a single reciprocating engine, the pressurized cabin, capabilities to climb up to 25,000 ft and others.

The PA-46-350P is in the PA-46 series of Piper Aircraft and was developed based on the Piper PA-46-310 aircraft, with increased maximum power and other improvements in flight performance.

(1) Basic Information

Maximum Takeoff Weight:		1,950 kg (4,300 lb)
Maximum Engine Speed:		2,500 rpm
Maximum Power :		350 HP
Stall Speed:	Flap 36°	58 kt (with landing gear down)
	Flap 0°	69 kt (with landing gear retracted)
Fuel Total Capacity:		122 gal (333 kg)

(2) Structure of Aircraft

The fuselage is an all-metal, semi-monocoque structure with three basic fuselage sections: the forward baggage section, the pressurized cabin section, and the empennage.

The seating arrangement is six seats in total, including two seats in the front row (left seat for a captain, right for a co-pilot), two seats in the middle row (facing backward) and two seats in the rear row (facing forward). Cabin access is through the door, located on the left aft of the fuselage.

The wings are low wings with sealed integral fuel tanks utilizing structural portions of the wings and hold 122 gal of fuel in total (including 2 gal of unusable fuel). Pitot tubes and retractable landing gear are installed in the underside of the wings. All-metal high-lift devices (flaps) are furnished on parts of the rear portions of the wings. The flap operates through a push rod by an electric motor-actuator. The flap has four positions of full-up (0°), 10°, 20°, and full down (36°), and a pilot selects every flap position by flap control lever located in the instrument panel.

The all-metal ailerons are operated by a cable system connected to the control wheel.

The empennage is all-metal; the vertical tail has a rudder and rudder trim, and the horizontal tail has elevators and elevator trims. The rudder is controlled with the rudder pedal at the foot of the pilot seat via torque tube. The elevators are controlled by the input of control column via a cable and rod.

### (3) Engine

The engine is Lycoming TIO-540-AE2A, a turbocharged horizontally opposed 6 cylinder air-cooled engine, which produces 350HP. The maximum rated output is 350 HP/2,500 rpm and manifold pressure is 42.0 inHg. It uses 100 or 100 LL octane rated aviation fuel.

A starter, two magnetos, a propeller governor, two alternators, two vacuum pumps, an air conditioner compressor, and two turbochargers are equipped as accessories.

A turbocharger is equipped, one each at the right and left sides of the engine. Turbochargers extract energy from engine cylinder exhaust gases and use this energy to compress engine induction air (maximum manifold pressure 42.0 inHg up to 20,600 ft). This allows the engine to maintain rated manifold pressure at high altitude. Engine induction air is compressed by the turbochargers, and the air temperature increases. The elevated air temperature is reduced by air intercoolers equipped on each side of the engine. This helps to cool the inside of the engine and improves engine power and efficiency.

The engine is equipped with a fuel injection system. An engine-driven fuel pump supplies pressured fuel to the fuel injection regulator, which measures airflows and meters the correct portion of fuel. The flow divider then directs the pressured fuel to each of the individual cylinder injector nozzles. After combustion of the fuel in cylinders, the exhaust gases are flowed to the exhaust manifold, then to the turbine of the turbocharger which extracts the exhaust energy to operate the compressor.

Oil temperature and pressure information can be checked on the pilot's instrument panel.

### (4) Propeller

The propeller is a Hartzell HC-I2YR-1BF/F8074, all-metal, and has variable pitch control with two blades of 80 inches in rotation diameter. The propeller governor, mounted on the front left of the engine, regulates the pressure of engine oil that flows through the propeller shaft to change propeller pitch angle. The propeller governor automatically changes the angle of the propeller in order to maintain the engine rpm selected by a pilot. A propeller control lever is connected to the propeller governor with cables to obtain the engine rpm selected by a pilot.

On this investigation, the propeller performance table was provided by the propeller manufacturer. Using this propeller performance table, correlating values such as an engine power, propeller pitch angle, and thrust were obtained by calculation.

(5) Engine Control

The engine is controlled by throttle lever, propeller control lever and mixture control lever, which are located on the control quadrant on the lower central instrument panel.

The throttle lever is used to control engine power. The throttle lever incorporates a gear-up warning horn switch, and the warning sound continues to rumble as a warning to a pilot, if the throttle lever was at the low power position before the landing gear is extended to be locked.

A propeller control lever adjusts the rpm of the engine. Setting the lever at the foremost position leads to maximize rpm (minimum propeller pitch angle) and setting it at the rearmost position (toward a pilot) minimizes rpm (maximum propeller pitch angle). A propeller governor automatically changes the propeller pitch in order to maintain the engine rpm selected by a pilot.

A mixture control lever adjusts the ratio of fuel and air. Moving the lever to the front in full makes the mixing ratio richer, and moving to the rear (to a pilot) in full suspends the supply of fuel and stops the engine.

2.7.2 Function of Each System

(1) Retractable landing gear

When the landing gear is down and locked, a gear light on the instrument panel light up. While the gear is being retracted, the gear light is off and the landing gear warning on an annunciator panel is lit. Completing to retract the gear, the landing gear warning turns off.

(2) Annunciator Panel

In the center of the instrument panel, the annunciator panel, containing warning lights, is installed.

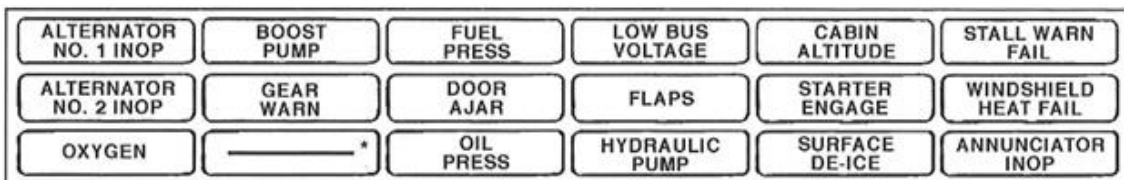

Figure 2.7.2 (2) Annunciator Panel

(3) Magnetos

The soundness of the magnetos is confirmed in before-takeoff check. The checking procedures on PA-46-350P are to set the prop speed lever at the foremost position, advance the throttle lever and set to reach 2,000 rpm. At this time, with the

condition that the low pitch stop is restricting the propeller pitch angle, the magnetos are alternatively switched to confirm that the power is decreased as one of the magnetos is turned off and that rpm could not be maintained and has dropped.

(4) Air-conditioning system

The Aircraft is equipped with an air-conditioning system utilizing a vapor cycle.\*2 It has a switch with three positions to change the operation: air-conditioner / off / blower. During the operation of the air-conditioner, cooled air comes out from six small, semispherical holes called “eyeballs”. The switch position and the operating status of the air-conditioner are as follows:

At the “air-conditioner” position: to send air into the cabin through producing cooled air by simultaneous operation of the compressor equipped on the left side of the engine and the blower (fan for ventilation)

At the “off” position: to stop the operation of the air-conditioner and the blower

At the “blower” position: to operate only the blower (fan for ventilation)

(5) Low pitch stop

The low pitch stop is a mechanism to physically limit the minimum propeller pitch angle (most fine pitch) for a variable pitch propeller. At almost all phases during a flight, a propeller governor controls the propeller pitch angles to keep constant rpm.

When the propeller pitch angle reaches the minimum angle set by the low pitch stop, the propeller pitch angle is placed under the restricted condition. If the engine power is reduced with the throttle lever, it becomes impossible to maintain rpm with a further reduction of propeller pitch angle, thus rpm reduces.

(6) Outline of TIT indicator

A TIT indicator equipped on the Aircraft is outlined as below.

The TIT indicator is used to monitor the temperature of exhaust gas from cylinders at the inlet to the turbocharger. In addition, while monitoring the inlet temperature of the turbocharger, adjusting the mixture ratio of air and fuel with a mixture control lever enables cruising at the most economical or the maximum power.

### 2.7.3 Characteristics of PA-46-350P

(1) Statement of a pilot with experience of flying the PA-46-350P

A pilot who has experience of flying the PA-46-350P described the

---

\*2 “A vapor cycle” is a mechanism of an air conditioner wherein; refrigerant gas compressed with a compressor is liquidized through cooling; the liquidized refrigerant gas is injected into an evaporator to vaporize the refrigerant gas; in the process of vaporization, heat is taken away from the surrounding and an evaporator is cooled; the cooled surrounding air is sent into the cabin via a blower to cool the inside of the cabin.

characteristics of the PA-46-350P and its operation at the Airport as below.

To take off from the Airport, he normally sets the flap at 10°. Even for a takeoff with a 10° flap, nose-up at a speed lower than 78 kt is inconceivable. As the PA-46-350P can only gain height at a very slow rate for climbing after takeoff, careful consideration is required regarding takeoff weight.

In general, when flying a familiar aircraft, when a situation like the number of persons on board, remaining fuel and others are known, it can be presumed that whether the maximum takeoff weight is exceeded or close to being exceeding based on experience without an accurate calculation.

(2) Statement of a maintenance engineer with experience of maintenance work on the PA-46-350P

A maintenance engineer who has experience of maintenance work on the PA-46-350P stated as follows:

In maintenance work in Japan, adjustment of the low pitch stop is not conducted. It is common to adjust rpm by adjusting the link between the speed lever and the propeller governor.

## 2.8 Confirmation of Weight and Position of the C.G.

2.8.1 “Confirmation before Departure by Pilot in Command” Stipulated in Civil Aeronautic Act

Civil Aeronautics Act (Act No. 231 enacted on 1952) stipulates “Confirmation before Departure by Pilot in Command” as follows (excerpts):

*“Confirmation before Departure”*

*Article 73-2*

*The pilot in command shall not start an aircraft, unless he/she has confirmed that the aircraft has no problems for flight and the necessary preparation for air navigation has been completed, pursuant to the provision of Ordinances of the Ministry of Land, Infrastructure, Transport and Tourism.*

Besides, Ordinance for Enforcement of the Civil Aeronautics Act stipulates as follows (excerpts):

*“Confirmation before Departure”*

*Article 164-14*

*(1) Matters that must be confirmed by the pilot in command pursuant to Article 73-2 of the Act are as listed below:*

*(i) Maintenance status of a subject aircraft and its equipment*

(ii) *Take-off weight, landing weight, location of the center of gravity, and weight distribution*

(Omitted)

(2) *A pilot in command shall, in the case of confirming the matters listed under item (i) of the preceding paragraph, conduct the inspection of aircraft logbook and other records on maintenance services, inspection of the exterior of aircraft and ground trial run of engines, and other elemental inspection of aircraft.*

## 2.8.2 Importance of Confirmation and Influence on Flight Performance of Weight and the Position of the C.G.

(1) “Airplane operation textbook” supervised by the Civil Aviation Bureau (Japan Civil Aviation Promotion Foundation, March 31, 2009, p.56) has the following descriptions:

*“A training plane should have a flight manual and a flight manual has a weight and balance calculation sheet. For an actual flight, a calculation must be made, using these tables and it must be confirmed that all values are within a specified range for weight and balance and complies with specific conditions of said flight. Calculation procedure is to determine an empty weight, weights of passengers on board, weights of loads (goods, fuel and lubrication) and other weights, then calculate the moment indexes on each weight (kg × m or lb × inch). Judge total of these moments being within the range surrounded by allowable weight and balance envelop or not to decide. If flying with C.G. positioning outside of this range, it could result to cause serious risks.”*

(2) Regarding weight and *position* of the C.G., and stall, “Flight Dynamics 1: Propeller Plane” published by Japan Aeronautical Engineer Association (the 2<sup>nd</sup> version issued and revised on September 15, 2006) has the following descriptions:

(Excerpts)

### *Section 14 Weight and Position of the C.G.*

*Because allowable ranges for weight and position of the C.G. are strictly restricted from the viewpoint of airframe strength and maneuverability, and these are indicated as operating limitations on airworthiness, it is essential to confirm that these are within allowable ranges at all phases of flight condition at the flight planning stage.*

#### *14.4 Loading limitations*

*The limit can be exceeded depending on how the aircraft is loaded. In this case, to limit the weight and to keep the C.G. within the allowable range, reduce the weight*

*or relocate the load.*

*a. Weight limitations*

*It should be noted that a small aircraft fully occupied with passengers and with a fully loaded fuel can often exceed the maximum take-off weight limitations.*

*(Omitted)*

*c. Location of C.G. at the aft limit of the allowable range*

*An aircraft fully occupied with passengers can easily exceed not just the weight limitations but the aft limit of the allowable range. Therefore, measures must be taken to keep the C.G. within the allowable range such as by leaving one of the rear seats vacant or measuring the weight of all people who are boarding and assigning lighter passengers to the rear seats.*

*If the C.G. of an aircraft is close to the aft limit of the allowable range, stability and controllability of the aircraft can still be maintained through careful piloting. However, the fore portion of the aircraft becomes lighter than desired, causing such strong tendencies as unstable ground roll, excessive rotation rate during takeoff, reduced stability at low airspeeds, risk of stall and spin, and greater difficulty in recovering from spin.*

*(Omitted)*

*Important precautions regarding the loading of a small aircraft are summarized below.*

*(a) An aircraft with fully loaded fuel shall not fly with the seats fully occupied or the cargo weight limit reached.*

*(b) An aircraft with the seats fully occupied shall have restriction of fuel on board, resulting in shortening flight time and distance.*

*(c) The position of C.G. shall be within the allowable range throughout the flight including the fuel consumption during the flight.*

*(d) Throughout the flight, the pilot shall stay aware of the position of the C.G. and shall have a correct understanding of the difference of control characteristics when the position of the C.G. is closer to the fore or aft limit of the allowable range.*

## *Section 15 Types of Stalls and Maximum Flight Movement*

### *15.1 Types of Stalls*

*The following characteristics should be understood as common characteristics of stall: a stall occurs in nature when the angle of attack for wings exceeds the stall*



*angle, the aileron is the first to lose effectiveness among the three components of the main control system and the rudder is the last to lose effectiveness; when the engine power is higher, the stall speed become slower but changes in attitude and height at the time of entering a stall become larger; when the GC position is aft, it is easier to enter a stall and hard to recover.*

(Omitted)

*The stall speed is slower for a power-on stall at high power than for a power-off stall, but it is easier to enter a stall with excessive nose-up in order to gain a climbing angle during climbing at the stage of climbing right after a takeoff. If the engine power is decreased sharply or the engine fails suddenly at this stage, there is the risk of suddenly entering a “Complete Stall,” from which it is almost impossible to recover, or a spin.*

*When the position of the C.G. is close to the aft limit, the generation of pitch-down moment is small even though coming close to the stall speed and a delay in maneuvering at an initial stall results in the risk of developing a flat spin which is hard to recover from.*

*Flat spin is also called a “horizontal spin” and is a type of spin which results in a rapid loss of height while rotating and maintaining the horizontal position of the airframe. Because the spin causes a stall condition for a horizontal tail and vertical tail at the same time and the elevator and rudder loses the effectiveness completely, recovery by maneuvering is not possible. Special caution is required as it is easier to cause a spin when the position of the C.G. is aft or the engine on one side of a multiple engine aircraft has failed.*

## **2.9 Meteorological Information**

### **2.9.1 General Weather Forecasts**

The general weather forecast released by Forecast Department of Japan Meteorological Agency at 10:44 on July 26, 2015 (the accident day), was as follows:

A high pressure system centered in the sea south of Japan covers East Japan. The Kanto-Koushin region has clear weather in general. On the 26<sup>th</sup>, a high pressure system covers the area and it is clear in general, but there will be rain or thunderstorms in the afternoon along mountains due to the effects of a high rise in daytime temperature and moist air, depending on the area.

The Tokyo region is clear on the 26<sup>th</sup> and will be cloudy at night.

## 2.9.2 Aeronautical Weather Observation at the Airport

### (1) METAR observations

Aeronautical weather observation for aerodrome routine meteorological report and aeronautical special meteorological report of the Airport were as follows:

10:00 Wind direction VRB, Wind velocity 1 kt, Visibility 15 km,  
Cloud: Amount 1/8, Type: Cumulus, Cloud base: 3,000 ft,  
Temperature 33°C, Dew point 22°C  
Altimeter setting (QNH) 29.86 inHg

11:00 Wind direction VRB, Wind velocity 2 kt, Visibility 15 km,  
Cloud: Amount 1/8, Type: Cumulus, Cloud base: 3,000 ft,  
Temperature 34°C, Dew point 22°C,  
Altimeter setting (QNH) 29.84 inHg

11:03 Wind direction VRB, Wind velocity 3 kt, Visibility 15 km,  
Cloud: Amount 1/8, Type: Cumulus, Cloud base: 3,000 ft,  
Temperature 34°C, Dew point 21°C,  
Altimeter setting (QNH) 29.84 inHg

### (2) Observations of wind direction and wind velocity at the time of takeoff

The meteorological information system of the Airport automatically records the instantaneous wind velocity and instantaneous wind direction every 3 seconds. From 10:57:12, when the Aircraft started the takeoff roll from near the threshold of Runway 17, to 10:58:09, immediately after the accident, the recorded instantaneous wind direction was 139° to 243° and the recorded instantaneous wind velocity was 0 to 1 kt. (See Attachment 4 Wind Data at the Time Relating to the Accident)

## 2.9.3 Temperature on the Runway

The temperature on the runway at the time of accident was not observed.

At around 14:00, August 11, 2015, the observation value of temperature on the runway of the airport was as follows:

At the centerline of the runway near A2 Taxiway (the estimated lift-off point of the Aircraft): 38.1 °C (approximately 1.5m above the ground)

In addition, the observation values according to the METAR were as follows:

14:00 Wind direction: 010°, Wind velocity: 5 kt,  
Cloud amount: 1/8 – 2/8, Type: Cumulus, Cloud base: 3,000 ft,  
Temperature: 34°C

## 2.10 Aerodrome Information

The aerodrome is located at approximately 22km to the west from Tokyo Station. Most of the ground is within Chofu City and a part extends over Mitaka City and Fuchu City.

Athletic fields and parks surround the Airport, but the area enclosing these have much housing. The official name is Tokyo Metropolitan Chofu Airport, and Tokyo Metropolitan government establishes and administers the management of the Airport.

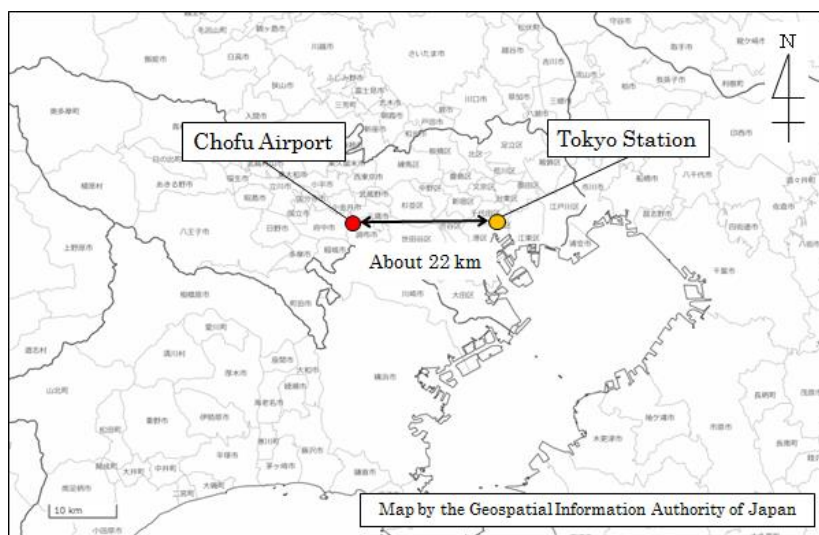

Figure 2.10-1 Location of the Airport

The Airport is at an altitude 139 ft at reference point, 800 m in length and 30 m in width, the runway magnetic direction is 170.20°/350.20°, and both ends of the runway have overrun areas, which are 60 m in length and 30 m in width. Regarding the lightings and markings related to the runway and the overrun areas, Visual Approach Slope Indicator System and Runway End Identifier Lights are installed.

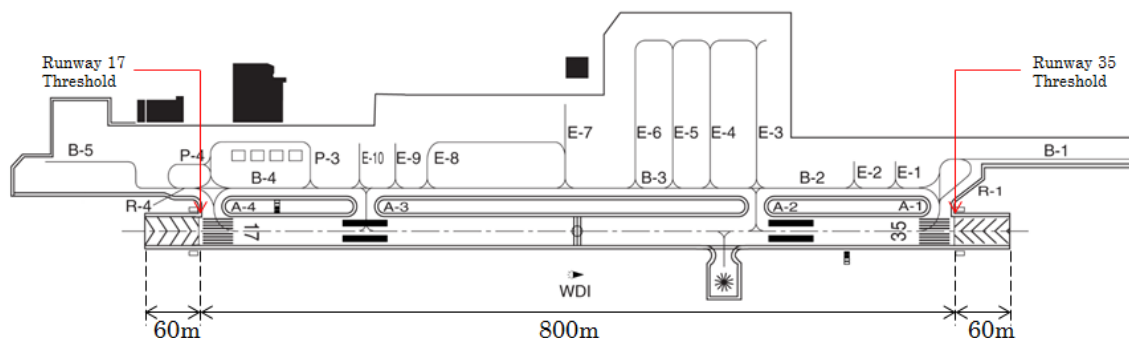

Figure 2.10-2 Site Plan of the Airport

### (1) History of the Airport

- March 1973: Return of the entire Airport area from the US Army
- March 1979: Commencement of a regular air service between Chofu and Niijima-island

December 1984:	Commencement of a regular air service between Chofu and Oshima-island
July 1992:	Transferring the management of the Airport from Civil Aviation Bureau to Tokyo Metropolitan Government
	Commencement of a regular air service between Chofu and Kozushima-island
December 25, 1998:	Government's permission to allow Tokyo Metropolitan Government to establish an aerodrome
March 31, 2001:	Started the service of an official airport (metropolitan airport for commuters air service)
April 1, 2006:	Commencement of aeronautical information service by Tokyo Metropolitan Government
April 2, 2013:	Started the service of a new passenger terminal
June 18, 2013:	Introduction of IFR to a remote island air routes
April 2, 2014:	Commencement of a regular air service between Chofu and Miyakejima-island

(2) Operation of the aerodrome

The aerodrome provider and administrator (Tokyo Metropolitan Government) set forth the Safety Codes for Tokyo Metropolitan Chofu Airport (Safety edition) (2009-KoToCho-43) (hereinafter referred to as "Safety Codes") based on Article 47-2 of the Civil Aeronautics Act and the Tokyo Metropolitan Airport Regulations (1962 Regulations 53) in order to administrate and manage the facilities of the Airport, properly and safely.

In order to secure the safety of the Airport and to preserve the living environment of the area, the aerodrome provider and administrator (Tokyo Metropolitan Government) set the operating procedures of the Airport, rules on entry to the Airport restricted area, the action plan at the time of an emergency, and the procedures concerning obstacle management around the Airport based on Safety Codes along with providing restrictions on operation hours, number of departure and arrival, and flight purpose in line with the Tokyo Metropolitan Airport Regulations and the operational guidelines based thereon.

(3) Situation surrounding the aerodrome

In order to ensure the safety of aircraft for departure and arrival, it is restricted to install, plant, or leave any structures, plants or any other objects which protrude above the approach surface, transitional surface or horizontal surface (hereinafter referred to as “restricted surfaces”), and the aerodrome provider and administrator (Tokyo Metropolitan Government) supervises to prohibit any objects protruding above the restricted surfaces from being installed through checking upon granting building certifications,

conducting patrols, inspection and others as needed.

There are no objects taller than the restricted surfaces of the Airport.

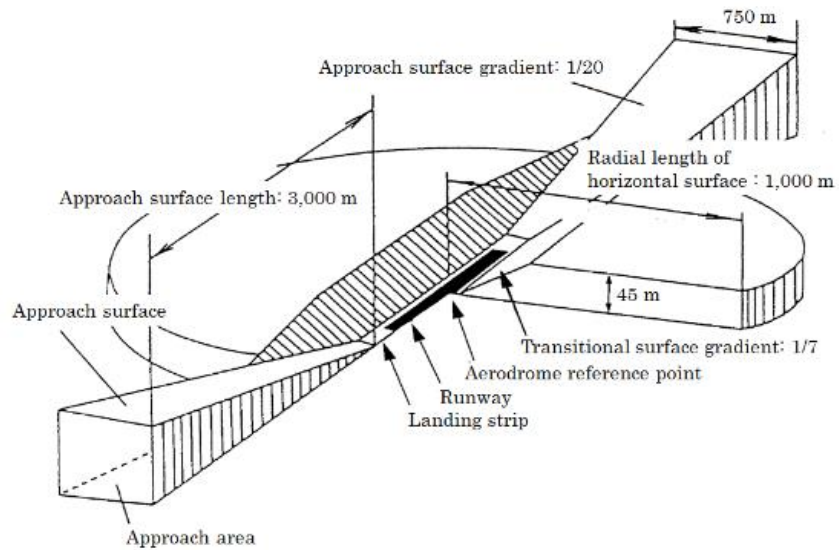

Figure 2.10-3 Restricted Surfaces Applied to the Airport

## 2.11 Details of Damage

### (1) Fuselage

The pilot seat and the cabin were lost to fire without the original shapes left. The aft part of the fuselage had damage but it kept its original shape there was little damage to the empennage.

### (2) Wings

The left wing was broken from the part connected to the fuselage and was lost to fire without the original shape left. The right wing nearly kept its original shape, but the damage by fire and the impact was severe.

Regarding the aileron, the left side was burnt completely and the right side kept its original shape but the damage by fire and the impact was severe.

The left side flap was completely lost to fire, the right side flap kept its original shape but the damage by fire and the impact was severe. The positional relation between the front edge of the flap and the flap-truck weight reduction hole of the Aircraft corresponded to be at 10° of the flap.

The flap actuator was positioned at 0° of the flap.

### (3) Engine

The engine nearly kept its original shape, but most of the non-metal parts were burnt.

Regarding turbochargers, the centrifugal compressor of the left turbocharger was melted, but the right turbocharger kept its original shape.

The engine accessories kept their original shapes, but the damage by fire and the impact was severe.

### (4) Propeller

One blade was broken and burnt, the tip of the other one was bent backward and burnt. Propeller governor remained mounted on the engine, but the tip was damaged.

### (5) Landing gears

The left landing gear was detached from the airframe but other landing gears were found as being retracted. All landing gears were damaged and burnt.



Photo 2.11 Leading Edge of Flap and Flap Truck

## **2.12 Medical Information**

According to the result of the legal autopsy carried out by the Tokyo Metropolitan Police Department on June 26, 2015, the following were found:

- (1) The captain tested negative for alcohol and drugs.
- (2) Cause of death for the captain, Passenger D and the resident of House D were death by fire.

## **2.13 Information on Fire, and Fire-fighting and Rescue Operations**

Based on the report provided by Chofu Fire Department, the following were found:

### **2.13.1 Information of Fire and Fire-fighting Operation**

On the day of the accident, at around 11:02, Chofu Fire Department received a call for firefighters from a resident near the accident site, saying that he/she looked outside because of a vehicle crashing sound and saw flames rising. Ambulances and fire engines arrived at the site at 11:08 and started the fire-fighting operation at 11:09. The fire was extinguished at 18:56 (total fire extinguishment confirmed). Because of this fire, a total of 102 fire engines and ambulance cars were dispatched.

### **2.13.2 Information on Rescue Operation**

Passengers A, B, and C, who escaped from the Aircraft, were evacuated to the front of the house located about 30 m from the site. Neighboring residents were pouring water over these three as a first aid. After the arrival of firefighters of Chofu Fire Department on the site, they were transported to hospitals by ambulance. The firefighters, while fighting the fire, rescued two survivors in the vicinity of the cabin of the Aircraft around 11:24 to 27, and found one survivor near the courtyard on the first floor of House D, and transported them by ambulance from the site.

The three persons carried out were the captain, Passenger D and the resident of House D, all of whom were confirmed dead at hospital. Adding to these, two residents of Houses C and D suffered injuries.

## **2.14 Descriptions in Flight Manual of the Aircraft**

Descriptions in PILOT'S OPERATING HANDBOOK AND FAA APPROVED AIRPLANE FLIGHT MANUAL of the Aircraft include the followings:

### **2.14.1 SECTION 2 LIMITATIONS (Excerpts)**

#### **2.7 POWER PLANT LIMITATIONS**

<i>(d) Engine Operating Limits</i>		
<i>(1) Maximum Engine Speed</i>		<i>2500 RPM</i>
<i>(2) Maximum Oil Temperature</i>		<i>245 °F</i>
<i>(3) Maximum Cylinder Head Temperature</i>		<i>500 °F</i>
<i>(4) Maximum Turbine Inlet Temperature</i>		<i>1750 °F</i>
<i>(5) Maximum Manifold Pressure</i>		
<i>(inches of mercury)</i>		
<i>To 20,600 feet</i>		<i>42</i>
<i>20,600 to 25,000 feet</i>		<i>42 - 1.6 per</i>
		<i>1000 foot increase</i>
<i>(6) Minimum Manifold Pressure (IN. HG.)</i>		
<i>Above 23,000 feet</i>		<i>23</i>
<i>(7) Minimum Propeller Speed (RPM)</i>		
<i>Above 23,000 feet</i>		<i>2400</i>
<i>(j) Propeller Diameter (inches)</i>		
<i>Minimum</i>		<i>79</i>
<i>Maximum</i>		<i>80</i>
<i>(k) Blade Angle Limits</i>		
<i>Low Pitch Stop</i>		<i>17.6° +/- 0.2°</i>
<i>High Pitch Stop</i>		<i>40.5° +/- 0.5°</i>

### *2.13 WEIGHT LIMITS*

<i>(a) Maximum Ramp Weight</i>	<i>4318 LB</i>
<i>(b) Maximum Takeoff Weight</i>	<i>4300 LB</i>
<i>(c) Maximum Landing Weight</i>	<i>4100 LB</i>
<i>(d) Maximum Zero Fuel Weight</i>	<i>4100 LB</i>

#### *NOTE*

*Refer to Section 5 (Performance) for maximum weight as limited by performance.*



*2.15 CENTER OF GRAVITY LIMITS*

<i>Weight</i>	<i>Forward Limit</i>	<i>Rearward Limit</i>
<i>Pounds</i>	<i>Inches Aft of Datum</i>	<i>Inches Aft of Datum</i>
<i>4300</i>	<i>143.3</i>	<i>147.1</i>
<i>4100</i>	<i>139.1</i>	<i>147.1</i>
<i>4000</i>	<i>137.0</i>	<i>146.5</i>
<i>2450 (and less)</i>	<i>130.7</i>	<i>137.6</i>
<i>2400</i>		<i>137.3</i>

*NOTE*

*Straight line variation between points given.  
The datum used is 100.0 inches ahead of the  
forward pressure bulkhead.  
It is the responsibility of the airplane owner and  
the pilot to ensure that the airplane is properly  
loaded. See Section 6 (Weight and Balance) for  
proper loading instructions.*

6.9 WEIGHT AND BALANCE DETERMINATION FOR FLIGHT

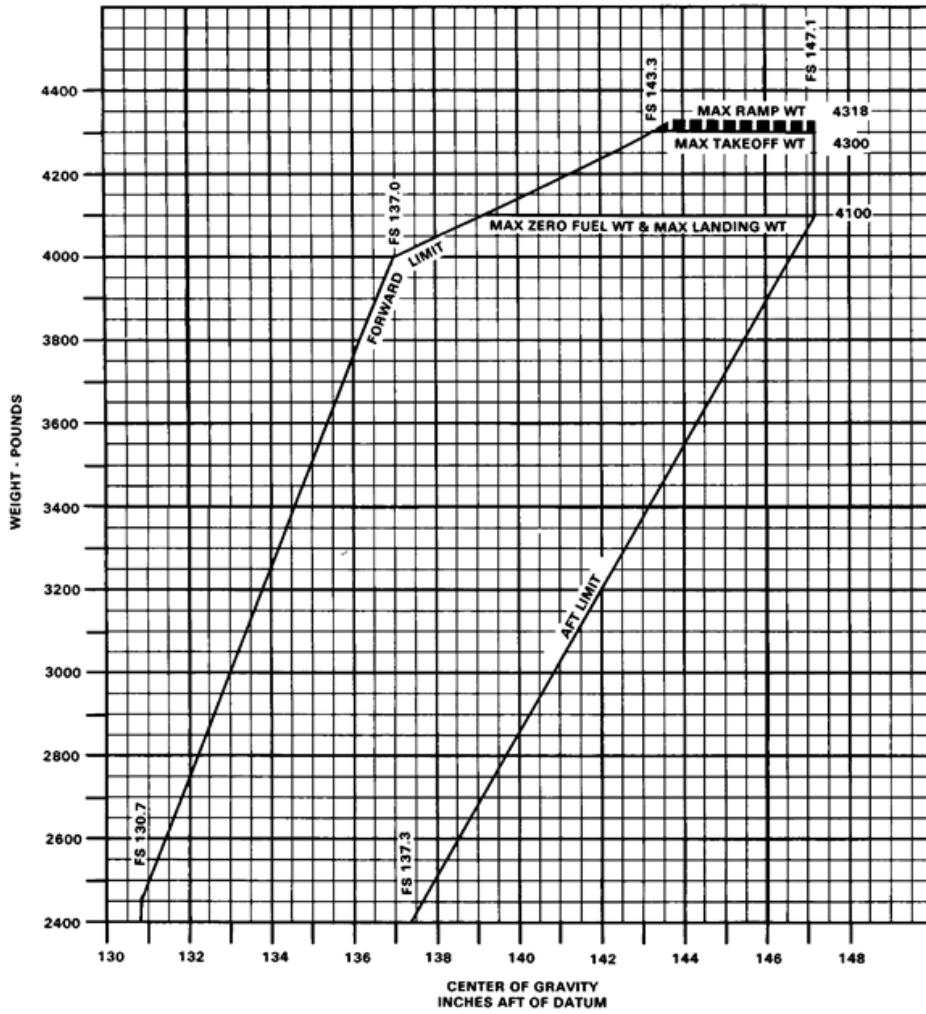

C.G. RANGE AND WEIGHT GRAPH

Figure 6-15

2.29 AIR CONDITIONING SYSTEM LIMITATIONS

AIR COND/BLWR switch in OFF or BLWR position for takeoffs and landings.

NOTE

REC BLWR switch may be in HIGH or LOW position.

2.33 *MAXIMUM SEATING CONFIGURATION*

*The maximum seating capacity is 6 (six) persons.*

2.14.2 *SECTION 3 EMERGENCY PROCEDURES (Excerpts)*

3.3c. *ENGINE POWER LOSS DURING TAKEOFF (3.9)*

*If sufficient runway remains for a normal landing, leave gear down and land straight ahead.*

*If area ahead is rough, or if it is necessary to clear obstructions:*

*Landing Gear Selector ..... UP*  
*Mixture ..... IDLE CUT-OFF*  
*Emergency (EMERG) Fuel Pump ..... OFF*  
*Fuel Selector ..... OFF*  
*Battery Master (after gear retraction)..... OFF*

*If sufficient altitude has been gained to attempt a restart:*

*Maintain Safe Airspeed.*

*Emergency (EMERG) Fuel Pump..... Check ON*  
*Fuel Selector .....SWITCH to tank containing fuel*  
*Mixture .....FULL RICH*  
*Induction Air ..... ALTERNATE*

*CAUTION*

*If normal engine operation and fuel flow are not reestablished, the emergency (EMERG) fuel pump should be turned OFF. The lack of a fuel flow indication could indicate a leak in the fuel system. If fuel system leak is verified, switch fuel selector to OFF.*

*If power is not regained:*

*Prepare for power off landing.*

3.9 *ENGINE POWER LOSS DURING TAKEOFF (3.3c)*

*The proper action to be taken if loss of power occurs during takeoff will depend*

on the circumstances of the particular situation.

If sufficient runway remains to complete a normal landing, leave the landing gear down and land straight ahead.

If the area ahead is rough, or if it is necessary to clear obstructions, move the landing gear selector switch to the UP position and prepare for a gear up landing. If time permits, move mixture control to idle cut-off, turn OFF the emergency (EMERG) fuel pump, move the fuel selector to OFF and, after the landing gear is retracted, turn battery master switch OFF.

If sufficient altitude has been gained to attempt a restart, maintain a safe airspeed, turn the emergency (EMERG) fuel pump ON, and switch the fuel selector to another tank containing fuel. Ensure the mixture is full RICH and move the induction air lever to the ALTERNATE position.

If engine failure was caused by fuel exhaustion, power will not be regained after switching fuel tanks until the empty fuel lines are filled. This may require up to ten seconds.

If power is not regained, proceed with Power Off Landing procedure (refer to paragraph 3.13).

### 2.14.3 SECTION 4 NORMAL PROCEDURES (Excerpts)

#### 4.3 AIRSPEEDS FOR SAFE OPERATIONS

The following airspeeds are those which are significant to the safe operation of the airplane. These figures are for standard airplanes flown at gross weight under standard conditions at sea level.

Performance for a specific airplane may vary from published figures depending upon the equipment installed, the condition of the engine, airplane and equipment, atmospheric conditions and piloting technique.

(a) Best Rate of Climb Speed.....	110 KIAS
(b) Best Angle of Climb Speed.....	81 KIAS
(c) Turbulent Air Operating Speed (See Subsection 2.1) .....	133 KIAS
(d) Landing Final Approach Speed (Full Flaps).....	77 KIAS
(e) Maximum Demonstrated Crosswind Velocity .....	17 KTS
(f) Maximum Flaps Extended Speed 10°.....	165 KIAS



4.19 GROUND CHECK (4.5f)

Set the parking brake. The magnetos should be checked at 2000 rpm with the propeller control set at full INCREASE. Drop off on either magneto should not exceed 175 rpm and the difference between the magnetos should not exceed 50 rpm. Operation on one magneto should not exceed 10 seconds. Conduct a preflight check of the ice protection systems for proper operation.

Check the suction gauge; the indicator should read 4.8 to 5.2 in. Hg at 2000 rpm. Check that both red flow buttons are pulled in.

Check the voltmeter and ammeters for proper voltage and alternator outputs. Check oil temperature and oil pressure. The temperature may be low for some time if the engine is being run for the first time of the day.

The propeller control should be moved through its complete range to check for proper operation and then placed in full INCREASE rpm for takeoff. Do not allow a drop of more than 500 rpm during this check. In cold weather, the propeller control should be cycled from high to low rpm at least three times before takeoff to make sure that warm engine oil has circulated.

Check that the fuel flow gauge is functioning, then retard the throttle. Check the annunciator panel lights with the press-to-test button.

Drain the manifold pressure line by running the engine at 1000 rpm and depressing the drain valve, located on the left side of the control pedestal under the instrument panel, for 5 seconds. Do not depress the valve when the manifold pressure exceeds 25 inches Hg.

4.5g Before Takeoff Checklist (4.21)

BEFORE TAKEOFF (21.)

Battery Master Switch .....ON  
Alternators .....ON - CHECK AMMETERS  
Pressurization Controls .....SET  
Flight Instruments .....CHECK  
Fuel Selector .....PROPER TANK  
Emergency (EMERG) Fuel Pump .....ON

*Engine Gauges* ..... *CHECK*  
*Induction Air* ..... *PRIMARY*

**WARNING**

*If flight into icing conditions (in visible moisture below +5°C) is anticipated or encountered during climb, cruise or descent, activate the aircraft ice protection system, including the pitot heat, as described in supplement No. 6 - Ice Protection System.*

**NOTE**

*Prolonged operation of the stall warning vane heater in temperatures greater than 5°C will reduce the operational life of the stall warning vane.*

*Pitot heat*..... *AS REQUIRED*  
*Stall warning heat*..... *AS REQUIRED*  
*Wshld heat*..... *AS REQUIRED*  
*Prop heat*..... *AS REQUIRED*  
*Seat Backs*.....*ERECT*  
*Seats*.....*adjusted& locked in position*  
*Armrests* .....*STOWED*  
*Mixture* ..... *FULL RICH*  
*Propeller Control* ..... *FULL INCREASE*  
*Belts/Harness* .....*FASTENED/ADJUSTED*  
*Empty Seats* .....*SEAT BELTS SNUGLY FASTENED*  
*Flaps* .....*SET*  
*Trim* .....*SET*  
*Controls* .....*FREE*  
*Door* .....*LATCHED*  
*Air Conditioner* ..... *OFF*  
*Parking Brake* ..... *RELEASED*

4.21 *BEFORE TAKEOFF (4.5g)*

*Ensure that the battery master and alternator switches are ON. Check that the cabin pressurization controls are properly set. Check and set all of the flight instruments as required. Check the fuel selector to make sure it is on the proper tank. Ensure emergency (EMERG) fuel pump is ON. Check all engine gauges. The induction air should be in the PRIMARY position.*

*Turn pitot, stall warning, windshield, and propeller heat ON if necessary.*

*Seats should be adjusted and locked in position. All seat backs should be erect and armrests stowed.*

*The mixture control should be set to full RICH and propeller control should be set to full INCREASE. Seat belts and shoulder harnesses should be fastened. Fasten the seat belts snugly around the empty seats.*

*Set the flaps and trim. Ensure proper flight control movement and response. The door should be properly latched and the door ajar annunciator light out. The air conditioner must be OFF to ensure normal takeoff performance. Release the parking brake.*

4.5h *Takeoff Checklist (4.23)*

*NOTE*

*Takeoffs are normally made with full throttle. However, under some off standard conditions, the manifold pressure indication can exceed its indicated limit at full throttle. Limit manifold pressure to 42 in. Hg maximum. (See Section 7.)*

*NOTE*

*During landing gear operation, it is normal for the HYDRAULIC PUMP annunciator light to illuminate until full system pressure is restored.*



*NORMAL TECHNIQUE (23a)*

*Flaps.....0° to 10°*  
*Trim.....SET*  
*Power.....SET TO MAXIMUM*  
*Liftoff..... 80-85 KIAS*  
*Climb Speed..... 90-95 KIAS*  
*Landing Gear (when straight ahead landing on runway not possible)..... UP*  
*Flaps.....RETRACT*

*0° FLAP TAKEOFF PERFORMANCE (4.23b)*

*Flaps..... 0°*  
*Trim.....SET*  
*Brakes.....APPLY*  
*Power.....SET TO MAXIMUM*  
*Brakes..... RELEASE*  
*Liftoff..... 78 KIAS*  
*Obstacle Clearance Speed..... 91 KIAS*  
*Landing Gear..... UP*

*SHORT FIELD TAKEOFF PERFORMANCE (23c.)*

*NOTE*

*Gear warning will sound when the landing gear is retracted with the flaps extended more than 10°.*

*Flaps..... 20°*  
*Trim.....SET*  
*Brakes.....APPLY*  
*Power.....SET TO MAXIMUM*  
*Brakes..... RELEASE*  
*Liftoff..... 69 KIAS*  
*Obstacle Clearance Speed..... 80 KIAS*  
*Landing Gear ..... UP*  
*Flaps..... RETRACT as speed builds thru 90 KIAS*

4.23 TAKEOFF (see charts in Section 5) (4.5h)

NOTE

*Takeoffs are normally made with full throttle. However, under some off standard conditions, the manifold pressure indication can exceed its indicated limit at full throttle. Limit manifold pressure to 42 in. Hg maximum. (See Section 7.)*

NOTE

*During landing gear operation, it is normal for the HYDRAULIC PUMP annunciator light to illuminate until full system pressure is restored.*

*Takeoffs are normally made with flaps 0° to 10°. For short field takeoffs or takeoffs affected by soft runway conditions or obstacles, total distance can be reduced appreciably by lowering the flaps to 20°.*

4.23a Normal Technique (4.5h)

*When the available runway length is well in excess of that required and obstacle clearance is no factor, the normal takeoff technique may be used. The flaps should be in the 0° to 10° position and the pitch trim set slightly aft of neutral. Align the airplane with the runway, apply full power, and accelerate to 80-85 KIAS.*

*Apply back pressure to the control wheel to lift off at 80-85 KIAS, then control pitch attitude as required to attain the desired climb speed of 90-95 KIAS. Retract the landing gear when a straight-ahead landing on the runway is no longer possible. Retract the flaps.*

4.23b 0° Flaps Takeoff Performance (4.5h)

*Retract the flaps in accordance with the Takeoff Ground Roll, 0° Flaps and Takeoff Distance Over 50 Ft. Obstacle, 0° Flaps charts in Section 5. Set maximum power before brake release and accelerate the airplane to 78 KIAS for liftoff. After liftoff, adjust the airplane attitude as required to achieve the obstacle clearance speed of 91 KIAS passing through 50 feet of altitude. Once immediate obstacles are*

*cleared, retract the landing gear and establish the desired enroute climb configuration and speed.*

*4.23c Short Field Takeoff Performance (4.5h)*

*NOTE*

*Gear warning will sound when the landing gear is retracted with the flaps extended more than 10°.*

*For departure from short runways or runways with adjacent obstructions, a short field takeoff technique with flaps set at 20° should be used in accordance with the Takeoff Ground Roll, 20° Flaps and Takeoff Distance Over 50 Ft. Obstacle, 20° Flaps charts. Maximum power is established before brake release and the airplane is accelerated to 69 KIAS for liftoff. After liftoff, control the airplane attitude to accelerate to 80 KIAS passing through the 50-foot obstacle height. Once clear of the obstacle, retract the landing gear and accelerate through 90 KIAS while retracting the flaps. Then establish the desired enroute climb configuration and speed.*

*4.5i Climb Checklist*

*MAXIMUM CONTINUOUS POWER CLIMB (4.25a)*

<i>Mixture.....</i>	<i>FULL RICH</i>
<i>Propeller Speed.....</i>	<i>2500 RPM</i>
<i>Manifold Pressure.....</i>	<i>MAXIMUM CONTINUOUS POWER</i>
<i>Cylinder Head Temperature (CHT).....</i>	<i>500°F MAX</i>
<i>Turbine Inlet Temperature (TIT).....</i>	<i>1750°F MAX</i>
<i>Oil Temperature.....</i>	<i>245°F MAX</i>
<i>Best Angle of Climb (short duration only).....</i>	<i>81 KIAS</i>
<i>Best Rate of Climb.....</i>	<i>110 KIAS</i>
<i>Pressurization Controls.....</i>	<i>SET</i>
<i>Emergency (EMERG) Fuel Pump.....</i>	<i>OFF at safe altitude</i>

*NOTE*

*For maximum engine life it is recommended to transition to Cruise Climb once a safe altitude is attained.*

*4.41 STALLS*

*The stall characteristics of the Malibu are conventional. An approaching stall is indicated by a stall warning horn which is activated between five and ten knots above stall speed. Mild airframe buffeting and pitching may also precede the stall.*

*The gross weight stalling speed with power off, landing gear extended, and full flaps is 58 KIAS. With the landing gear retracted and flaps up, this speed is increased to 69 KIAS. Loss of altitude during stalls can be as great as 700 feet, depending on configuration and power.*

*NOTE*

*The stall warning system is inoperative with the battery and alternator switches OFF.*

*During preflight, the stall warning system should be checked by turning the battery switch on and pressing the stall warning test switch to determine if the horn is actuated.*

*2.14.4 SECTION 5 PERFORMANCE (Excerpts)*

*5.3 INTRODUCTION - PERFORMANCE AND FLIGHT PLANNING*

*The performance information presented in this section is based on measured Flight Test Data corrected to I.C.A.O. standard day conditions and analytically expanded for the various parameters of weight, altitude, temperatures, etc.*

*(Omitted)*

*An aircraft to have appropriate service following the procedure shown in the performance table will recreate the performance.*

*(Omitted)*

*To obtain the performance shown in the performance table, do not forget to follow the procedure written in the figure/table.*

**WARNING**

*Performance information derived by extrapolation beyond the limits shown on the charts should not be used for flight planning purposes*

**5.5 FLIGHT PLANNING EXAMPLE**

**(a) Aircraft Loading**

*The first step in planning the flight is to calculate the airplane weight and center of gravity by utilizing the information provided by Section 6 (Weigh and Balance) of this handbook.*

*(Omitted)*

*Make use of the Weight and Balance Loading Form (Figure 6-11) and the C.G. Range and Weight graph (Figure 6-15) to determine the total weight of the airplane and the center of gravity position.*

*(Omitted)*

**(b) Takeoff and Landing**

*(Omitted)*

*Apply the departure airport conditions and takeoff weight to the appropriate "Takeoff Ground Roll and Takeoff Distance (Figures 5-13, 5-15 5-17 and 5-19)" to determine the length of runway necessary for the takeoff and/or obstacle clearance.*

*(Omitted)*

*The conditions and calculation for flight plan are shown as follows: The takeoff and landing distances required for the flight have fallen below the available runway lengths.*

	<i>Departure airport</i>	<i>Designated airport</i>
<i>(1) pressure altitude</i>	<i>1000 ft</i>	<i>1000 ft</i>
<i>(2) temperature</i>	<i>25°C</i>	<i>25°C</i>
<i>(3) wind component</i>	<i>15 kts</i>	<i>10 kts</i>
<i>(4) length of runway</i>	<i>3400 ft</i>	<i>5000 ft</i>
<i>(5) required takeoff distance and landing distance</i>	<i>2230 ft</i>	<i>1830 ft</i>

## 2.14. 5 SECTION 6 WEIGHT AND BALANCE (Excerpts)

### 6.1 GENERAL

*In order to achieve the performance and flying characteristics which are designed into the airplane, it must be flown with the weight and center of gravity (C.G.) position within the approved operating range (envelope). Although the airplane offers flexibility of loading, it cannot be flown with the maximum number of adult passengers, full fuel tanks and maximum baggage. With the flexibility comes responsibility. The pilot must ensure that the airplane is loaded within the loading envelope before he makes a takeoff.*

*Misloading carries consequences for any aircraft. An overloaded airplane will not take off, climb or cruise as well as a properly loaded one.*

*The heavier the airplane is loaded, the less climb performance it will have.*

*Center of gravity is a determining factor in flight characteristics. If the C.G. is too far forward in any airplane, it may be difficult to rotate for takeoff or landing. If the C.G. is too far aft, the airplane may rotate prematurely on takeoff or tend to nose-up during climb. Longitudinal stability will be reduced. This can lead to inadvertent stalls and even spins; and spin recovery becomes more difficult as the center of gravity moves aft of the approved limit.*

*A properly loaded airplane, however, will perform as intended. Before the airplane is licensed, a basic empty weight and C.G. location is computed (basic empty weight consists of the standard empty weight of the airplane plus the optional equipment). Using the basic empty weight and C.G. location, the pilot can determine the weight and C.G. position for the loaded airplane by computing the total weight and moment and then determining whether they are within the approved envelope.*

*The basic empty weight and C.G. location are recorded in the Weight and Balance Data Form and the Weight and Balance Record (Attachment 2 "Weight and Balance Data Form"). The current values should always be used. Whenever new equipment is added or any modification work is done, the mechanic responsible for the work is required to compute a new basic empty weight and C.G. position and to write these in the Aircraft Log Book and the Weight and Balance Record (Attachment 2 "Weight and Balance Data Form"). The owner should make sure that it is done.*

*A weight and balance calculation is necessary in determining how much fuel or baggage can be boarded so as to keep within allowable limits. Check calculations prior to adding fuel to insure against improper loading.*

*The following pages are forms used in weighing an airplane in production and in computing basic empty weight, C.G. position, and useful load. Note that the useful load includes usable fuel, baggage, cargo and passengers. Following this is the method for computing takeoff weight and C.G*

#### **6.7 GENERAL LOADING RECOMMENDATIONS**

*For all airplane configurations, it is the responsibility of the pilot in command to make sure that the airplane always remains within the allowable weight vs. center of gravity while in flight.*

*The following general loading recommendation is intended only as a guide. The charts, graphs, instructions and plotter should be checked to assure that the airplane is within the allowable weight vs. center of gravity envelope.*

*(a) Pilot Only*

*Load rear baggage compartment first.*

*(b) 2 Occupants - Pilot and passenger in front*

*Load rear baggage compartment first. Without aft baggage, fuel load may be limited by forward envelope for some combinations of optional equipment.*

*(c) 3 Occupants - 2 in front, 1 in rear*

*Baggage in nose may be limited by forward envelope.*

*(d) 4 Occupants - 2 in front, 2 in rear*

*Fuel may be limited for some combinations of optional equipment.*

*(e) 5 Occupants - 2 in front, 1 in middle, 2 in rear*

*Investigation is required to determine optimum baggage load.*

*(f) 6 Occupants - 2 in front, 2 in middle, 2 in rear*

*With six occupants fuel and/or baggage may be limited by envelope.*

*Load forward baggage compartment first.*

*NOTE*

*With takeoff loadings falling near the aft limit, it is important to check anticipated landing loadings since fuel burn could result in a final loading outside of the approved envelope.*

*Always load the fuel equally between the right and left tanks.*



## 2.15 Descriptions from the Maintenance Manual and Other Documents for PA-46-350P

### 2.15.1 TIO-510-AE2A Operator's Manual by the Engine Manufacturer

The following descriptions are included in TIO-510-AE2A Operator's Manual by the engine manufacturer:

(Excerpts)

*With propeller in minimum pitch angle, set the engine to produce 50-65% power as indicated by the manifold pressure gage. Mixture control should be in the full rich position. At these settings, the ignition system and spark plugs must work harder because of the greater pressure within the cylinders. Therefore, any weakness in the ignition system will be more apparent. Mag checks at low power settings will only indicate fuel-air distribution quality.*

(Excerpts)

*Correct power approximately 1% for each 10°F variation in air temperature from standard altitude temperature. Add correction for temperature below standard; subtract correction for temperature above standard.*

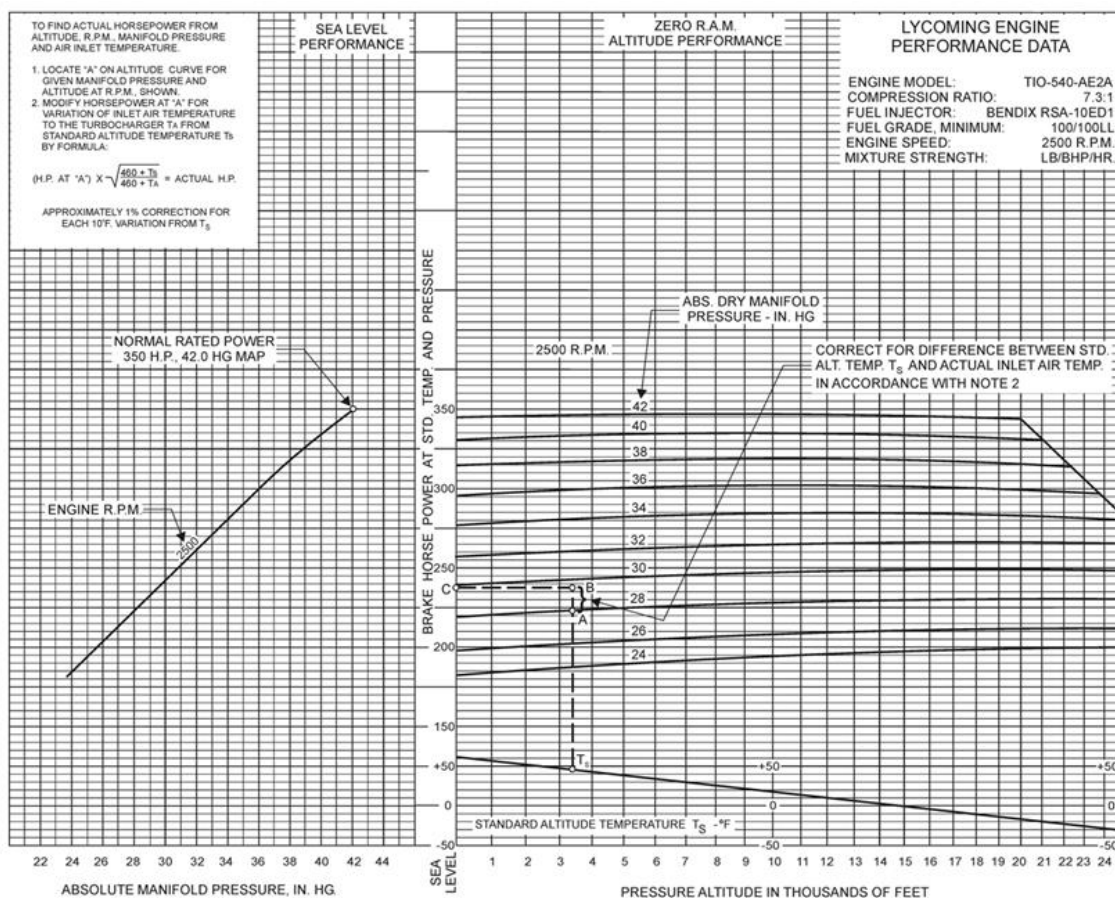

Figure 3-4 Sea Level/Altitude Performance Curve

### 2.15.2 Propeller Owner's Manual (Manual No. 115N) by the Propeller Manufacturer

According to the Propeller Owner's Manual (Manual No. 115N) by the Propeller Manufacturer, adjusting the low pitch stop, not the propeller governor, in the checking of the static RPM may cause a change to the blade angle at the low pitch stop and also a change to rpm at that position.

(Excerpts)

- (1) *Set the brakes and chock the aircraft or tie aircraft down.*
  - (2) *Back the governor Maximum RPM Stop out one turn.*
  - (3) *Start the engine.*
  - (4) *Advance the propeller control lever to Max (max RPM), then retard the control lever one inch (25.4 mm)*
  - (5) *SLOWLY advance the throttle to maximum manifold pressure.*
  - (6) *Slowly advance the propeller control lever until the engine speed stabilize.*
    - (a) *If engine speed stabilized at the maximum power static RPM specified by the TC or STC holder, then the low pitch stop is set correctly.*
    - (b) *If engine speed stabilizes above or below the rated RPM, the low pitch stop may require adjustment. Refer to the Maintenance Practices Section of this manual.*
- (61-00-15)

Furthermore, the manual includes the following warnings.

(Excerpts)

**WARNING:** *SIGNIFICANT ADJUSTMENT OF THE LOW PITCH STOP TO ACHIEVE THE SPECIFIED STATIC PRM MAY MASK AN ENGINE POWER PROBLEM.*

*Refer to the following applicable procedure for accomplishing and adjustment to the low pitch angle:*

(Omitted)

*Turning the low pitch stop screw one revolution equals 0.042 inch (1.06 mm) of linear travel, and results in approximately 1.4 degree blade angle change. This blade angle change results in an RPM increase/decrease of approximately 200 RPM.*

## 2.16 Tests and Verifications Information

The teardown inspection of the engine, propeller, magnetos and air-conditioner implemented to ascertain the conditions of the Aircraft at the time of the accident is

outlined as follows:

(See Attachment 6 Teardown Inspection of Engine, Propeller and Others)

#### 2.16.1 Teardown Inspection of the Engine

Regarding the engine of the Aircraft, a teardown inspection was carried out at a facility of the engine manufacturer from January 12 to 13, 2016. The engine manufacturer conducted the teardown inspection of the engine and the engine accessories, and the propeller manufacturer did the teardown inspection of the turbochargers. The whole of the engine showed the damage by the crash and the fire after the crash. There was nothing found that would have preclude the engine from making power prior to the crash.

As the result of the teardown inspection, no possibilities to lead to any malfunction at the time of the crash were confirmed in the engine, the engine accessories and the turbochargers.

#### 2.16.2 Teardown Inspection of the Propeller

Regarding the propeller and the propeller governor, the propeller manufacturer conducted the teardown inspection at the same time as the engine teardown inspection. The propeller was found to be set at low-pitch angle or within that vicinity. One of the blades had the scratch mark on the blade cord direction on the tip of the camber side, and it means that the blade was rotating before the crash. The other propeller blade was almost completely burnt down in the post-crash fire.

As the result of the teardown inspection, no discrepancy were noted that would have prevented propeller operation prior to the crash including the propeller governor.

#### 2.16.3 Teardown Inspection of the Magnetos

In order to investigate the ignition system of the engine, the teardown inspection of the two magnetos as the major parts of the system was conducted on August 2, 2016. The visual checks to the inside of the magnetos showed severe damage on both magnetos due to the post-crash fire. Especially, the non-metal parts were lost to fire, suffered severe damage and were charred. Due to these conditions, functional inspections could not be carried out.

#### 2.16.4 Teardown Inspection of the Air Conditioner

Regarding the operating status of the air-conditioning at the time of the takeoff, the teardown inspection was carried out at the air-conditioning manufacturer on May

9, 2016. It was not possible to determine whether the air-conditioner was operating or not based on the residue status and the heated status due to the fire of the machine oil of the refrigerator.

## 2.16.5 Verification of the Flight Route based on Images

### 2.16.5.1 The obtained visual materials

On the accident date, the flight situation was recorded in the multiple visual images taken around Chofu Airport. The locations of the shooting of these visual materials are indicated in Figure 2.16.5.1 and the visual materials are listed in Table 2.16.5.1.



Figure 2.16.5.1 Filming Locations

Table 2.16.5.1 List of Visual Materials

Filming location	Type of visual images	acronym
Observation deck located at the Terminal	Camcorder: Handheld	OBS
Baseball field E2 at Chofu Kichiatochi Sports Park	Camcorder: Fixed	E2
Softball field C at Osawa Sports Park	Camcorder: Fixed	SC
Softball field D at Osawa Sports Park	Camcorder: Fixed	SD

Surveillance camera at Runway 35 Threshold	Fixed: Only visuals	R35
Municipal Nishi-no-machi Soccer Field	Camcorder: Handheld	NS
Mainly in the cabin of the Aircraft	Still images with GPS data	SP

Hereinafter, use these acronyms to refer to the visual materials.

(1) Visual images of OBS

According to the visual images of OBS, the situation during the takeoff roll of the Aircraft is as shown in Figure 2.16.5.1 (1).

Time	The situation of the aircraft
10:57:35	
10:57:36	
10:57:37	
10:57:38	

Figure 2.16.5.1 (1) The Aircraft at the Takeoff Roll (OBS)

(2) Visual images of R35

According to the visual images of R35, the situation during the climbing of the Aircraft is as shown in Photo 2.16.5.1 (2), as a sequential photo.



Photo 2.16.5.1 (2) The Aircraft during the Climb after Takeoff (R35)

(3) Visual images of SC

According to the visual images of SC, the situation during the climbing of the Aircraft is as shown in Photo 2.16.5.1 (3), as a sequential photo.



Photo 2.16.5.1 (3) -1 The Aircraft during the Flight (SC)



Photo 2.16.5.1 (3)-2 Condition of Black Smoke (SC)

(4) Visual images of SD

According to the visual images of SD, the situation during the climbing of the Aircraft is as shown in Photo 2.16.5.1 (4), as a sequential photo.



Photo 2.16.5.1 (4) The Aircraft during the Flight (SD)

2.16.5.2 Speed during the takeoff roll

The history of the speed during the takeoff roll was obtained from the images of OBS, SP and E2. Because the shooting positions of these images were identified, the time and the ground speed were calculated based on the comparison with the objects on the ground seen in the images. The true air speed at no wind was first calculated based on the ground speed obtained from the images and then the calibrated air speed was estimated based on the calculated true air speed on the premise of the temperature being 34°C and the atmospheric pressure being 29.84 inHg. The speed during the flight was estimated by the same method. This report, except as otherwise noted, expresses the calibrated air speed as the speed. The obtained speed is shown in Figure 2.16.5.2.

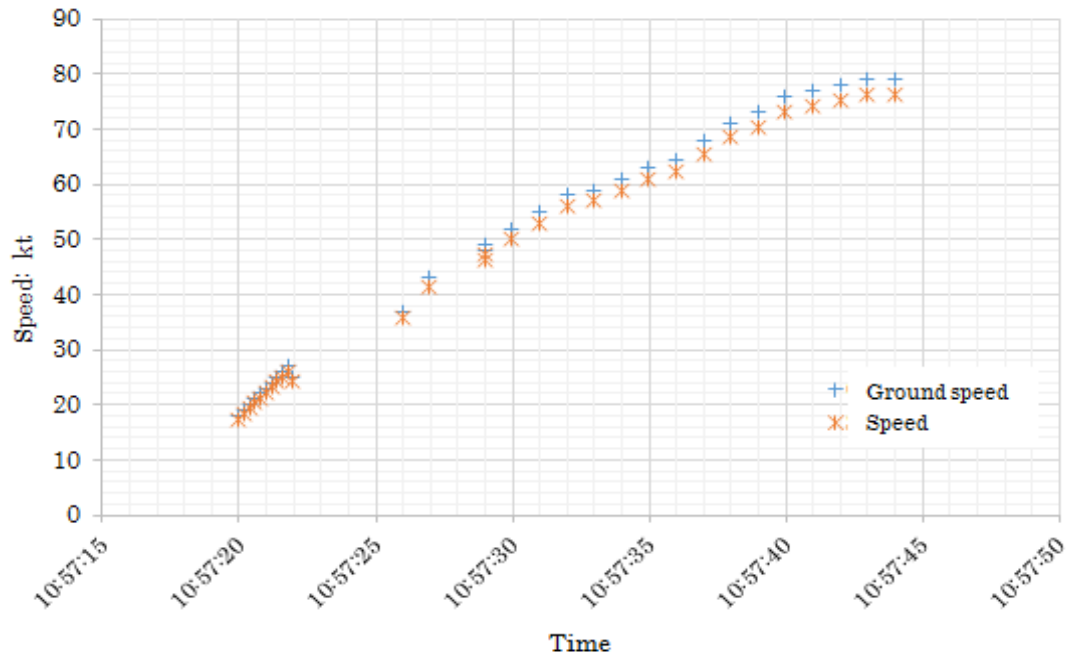

Figure 2.16.5.2 Estimated Ground Speed and Speed at the Time of Takeoff Roll

### 2.16.5.3 The changes of speed and height after the takeoff

The angle of views, the lens distortions, the shooting directions and other elements were measured based on the surveying from the shooting locations. The north-south flight route was estimated based on the R35 images, and the position and the height per time were estimated based on the images of SC and SD. The times of the SC and SD images were synchronized after adding the sound propagation delay caused by the distances between the crash site and the shooting locations onto the time when the crash sound was recorded. Because the SD and R35 images contained images recorded right after the takeoff, the synchronization was based on the estimated position. The estimated speed from the SC and SD images are shown in Figure 2.16.5.3-1 and the estimated heights are shown in Figure 2.16.5.3-2. The estimated speeds are vibrational, but this is due to the fluctuation of the reference point of the airframe because the images of the Aircraft are blurred and small. The speeds (the ground speed based on the smartphone GPS) recorded in the photos taken in the cabin of the Aircraft are also shown in Figure 2.16.5.3-1.

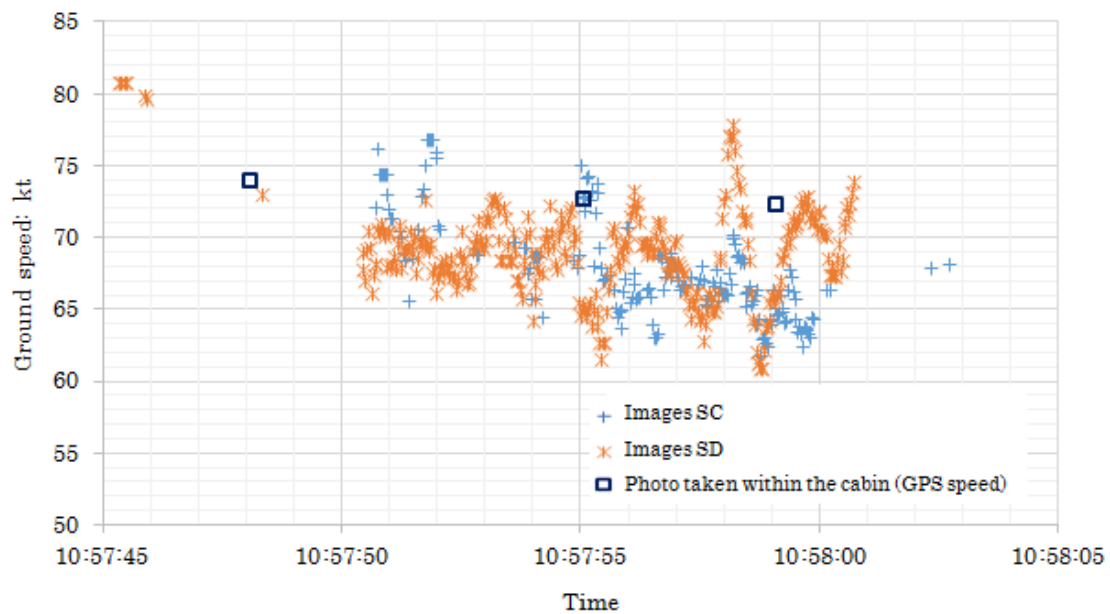

Figure 2.16.5.3-1 Changes of the Ground Speed after Takeoff



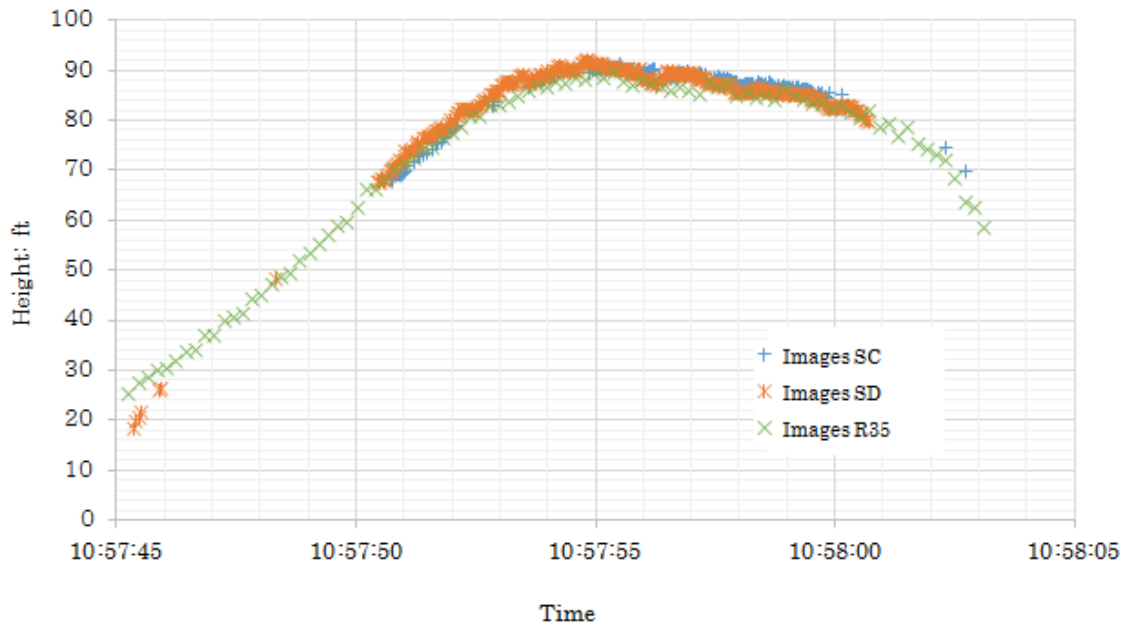

Figure 2.16.5.3-2 Changes of the Height after Takeoff

Integrating the results of these analyses mentioned above, the speed, height and pitch angle 2.16of the Aircraft at the accident day were reconstructed against the time are shown in Figure 2.16.5.3-3. The reconstructed speed and height against the distances are shown in Figure 2.16.5.3-4.

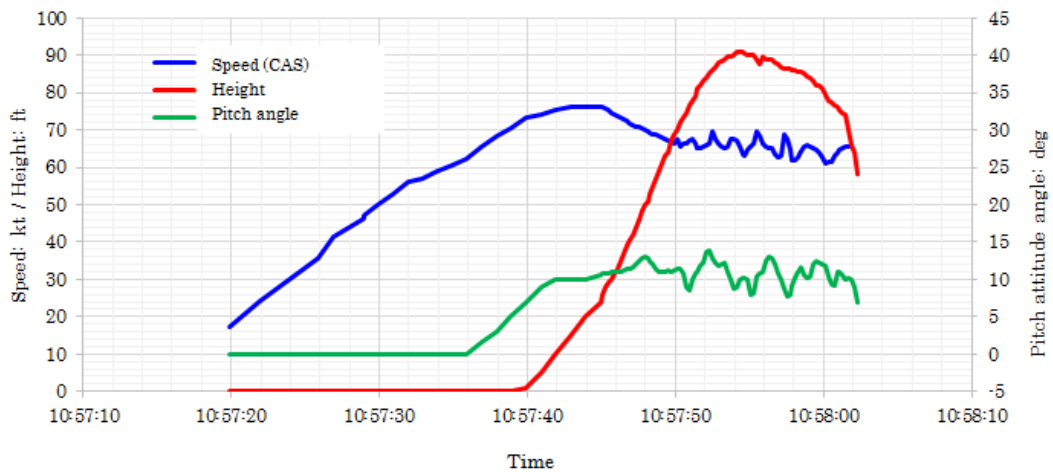

Figure 2.16.5.3-3 Reconstructed Speed (CAS), Height and Pitch Attitude

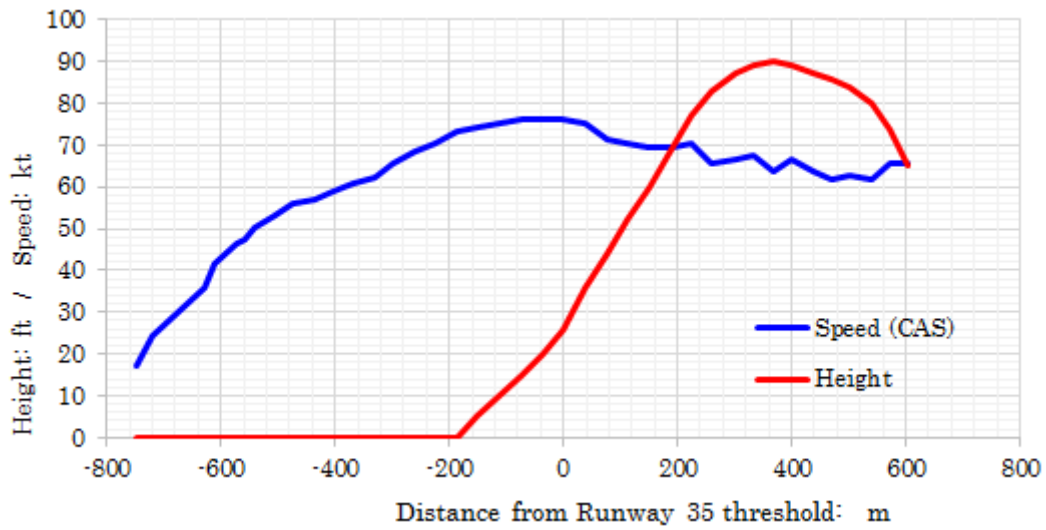

Figure 2.16.5.3-4 Reconstructed Speed (CAS) and Height

#### 2.16.5.4 Estimated flight route

The estimated flight route is shown in Figure 2.16.5.4, together with the outside photos taken in the cabin of the Aircraft with the time stamped on the photos.

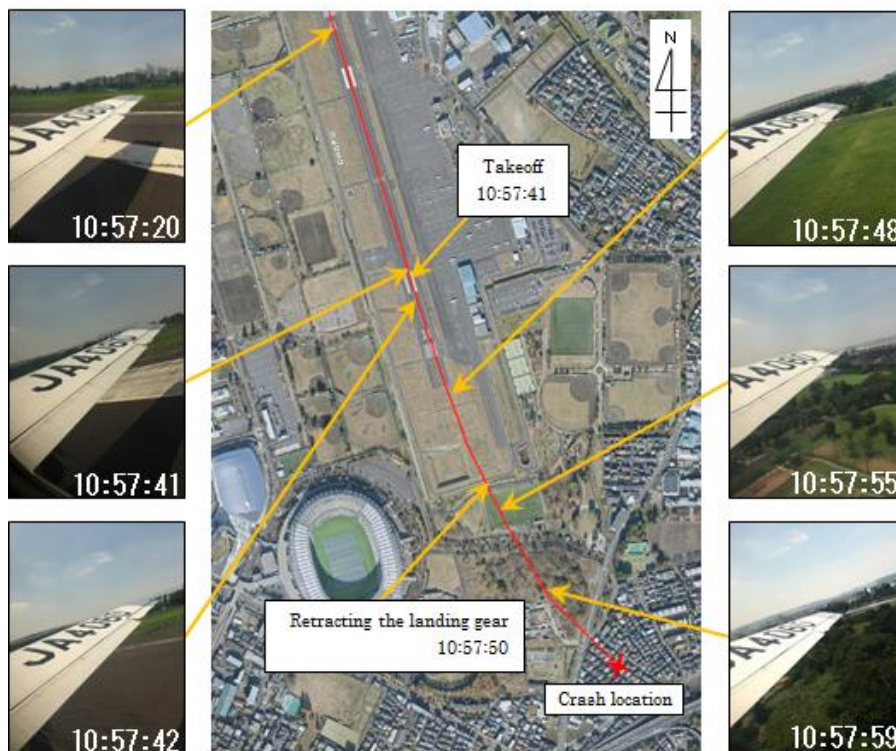

Figure 2.16.5.4 Estimated Flight Route

(See Attachment 1 Photo Taken in the Cabin of the Aircraft (Right wing, flap and others))

### 2.16.5.5 Sound analysis during the before-takeoff check

The sound of the before-takeoff check was recorded in the E2 images. Frequencies of these were analyzed using Sonic Visualizer\*<sup>3</sup>, and the peak frequencies are shown in Figure 2.16.5.5. The changes of the sound were matched with the sound changes that are generated at the time of the check procedures defined in the flight manual.

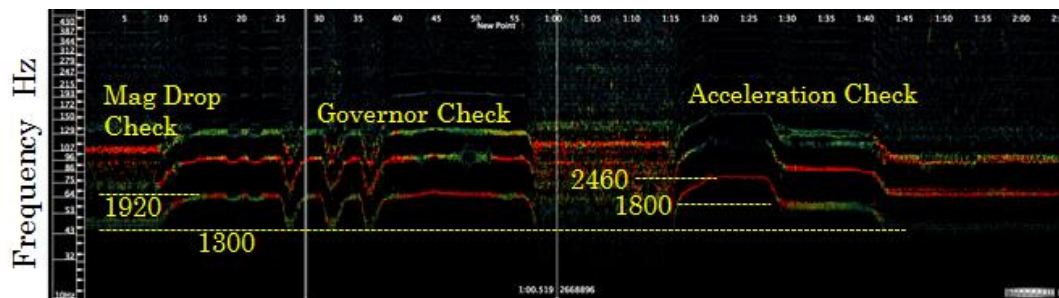

Figure 2.16.5.5 Sound during the Before-takeoff Check

### 2.16.5.6 Sound analysis during the flight

Sound during the flight were recorded in multiple images. Analyzing of these with Sonic Visualizer, the sound of the propeller and the sound of the engine were identified and the frequencies could be obtained. As an example, Figure 2.16.5.6 shows the sound recorded in the SD images. The frequency of the propeller sound was approximately 82 Hz. Because the propeller of the Aircraft has two blades, the rpm was calculated as approximately 2,460 rpm and there were no significant fluctuations observed. Moreover, no sound indicating any anomaly of the engine or other parts was observed.

The sound during the flight contained noises, reflected and other sounds, and this sound analysis did not take into account noise, reflected sound and the Doppler effects by movement of the Aircraft.

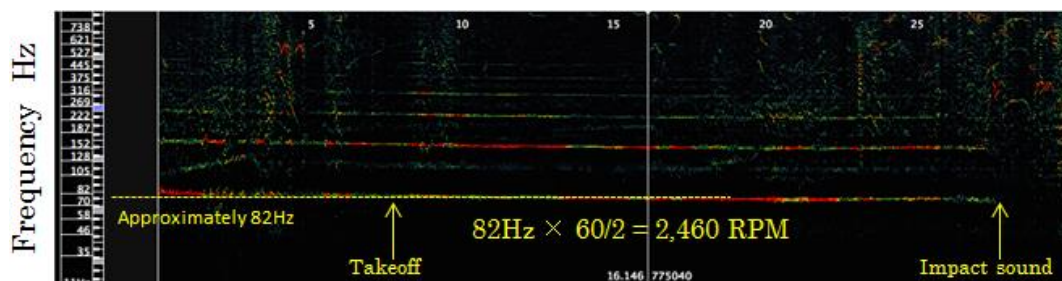

Figure 2.16.5.6 Sound during the Flight 1

\*<sup>3</sup> Sound Analysis: Chris Cannam, Christian Landone, and Mark Sandler, Sonic Visualizer: An Open Source Application for Viewing, Analyzing, and Annotating Music Audio Files, in Proceedings of the ACM Multimedia 2010 International Conference.

2.16.5.7 Readings of the instrument panel in the images taken in the cabin of the Aircraft

(1) Information from manifold pressure meter and fuel flow meter

The parts of the manifold pressure meter and fuel flow meter could be seen in the images taken in the cabin of the Aircraft. The enlarged images are shown in Figure 2.16.5.7(1).

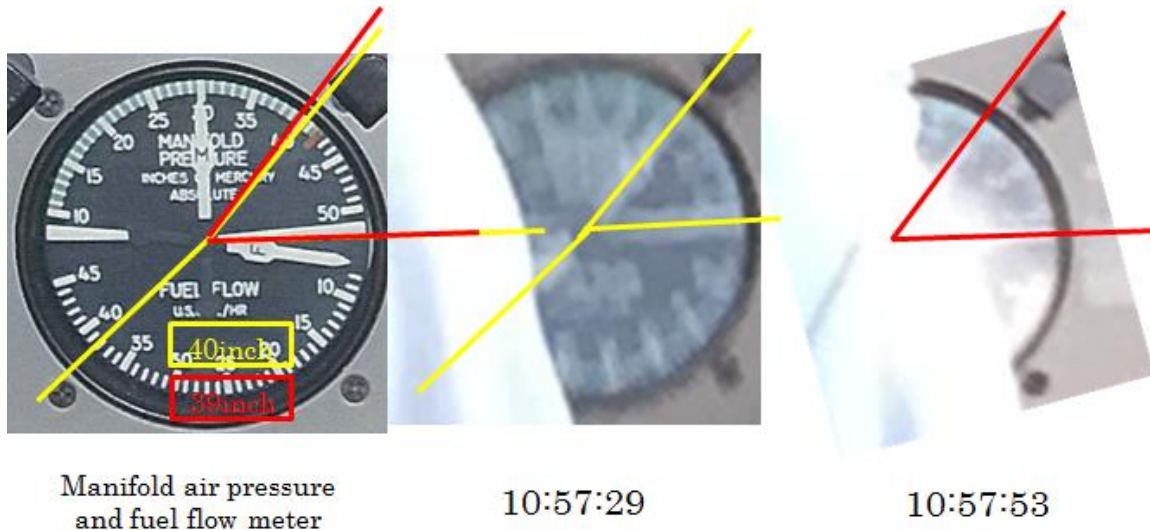

Figure 2.16.5.7 (1) Manifold Pressure and Fuel Flow Meter Taken in the Cabin of the Aircraft

Based on the readings of these meters, the manifold pressure was approximately 40 inHg right after the start of the takeoff roll (10:57:29) and was approximately 39 inHg while retracting the landing gear after the takeoff (10:57:53).

(2) TIT gauge information



Figure 2.16.5.7 (2) TIT Gauge Taken in the Cabin of the Aircraft

The TIT (Turbine Inlet Temp) value could also be read in the same images that show the manifold pressure meter and fuel flow meter as mentioned in (1). The enlarged images are shown in Figure 2.16.4.7 (2).

Base on the readings of these, the TIT was approximately 980°F during the takeoff roll (10:57:29) and was 1,010°F while retracting the landing gear after the takeoff (10:57:53).

TIT is the temperature at the inlet of the turbocharger, which corresponds to the exhaust temperature of the engine. The range from 1,200 to 1,750°F is the normal operating range of the Aircraft indicated as a green arc on the TIT meter. The flight manual has a description of a maximum value of 1,750°F as the operating limit, but there is no setting for a minimum value. Upon a flight test of other aircraft of the same type, TIT was approximately 1,400°F at the maximum power.

(3) Landing gear warning light

At In the images at 10:57:29 as described in (1) and (2) above, the landing gear warning light, which shows that the landing gear is being retracted, did not illuminate, but the images at 10:57:53 show the landing gear warning light illuminated.



Figure 2.16.5.7 (3) Status of Landing Gear Warning Light(10:57:53)

(See Attachment 2 Photos Taken in the Cabin of the Aircraft (Instrument Panel)

#### 2.16.6 Analysis of the Past Flight

On July 22, 2015, the flight of the Aircraft was recorded by the camera installed within the aerodrome. This flight was the last flight before the accident. From the images, performance and flight control mainly at the time of takeoff roll was analyzed. The flight record shows that the captain was piloting the Aircraft.

As shown in Photo 2.16.6, only the scene of passing the threshold of the runway and climbing gradually was recorded, and based on this scene, the speed and height at the time of passing through the threshold of the runway was calculated. Estimated takeoff weight based on loaded fuel and the number of the persons on board obtained from the submitted notification of the airport use, the meteorological data (outside temperature, wind) and others are shown in Table 2.16.6-1

The position to start the takeoff roll of this flight is unknown, but if the starting point is assumed to be about 10 m from the threshold of Runway 17, the threshold of Runway 35 is the point about 790m from the starting point. Therefore, according to the flight manual, the Aircraft should pass the threshold of Runway 35 at a height of approximately 50 ft with a speed of slightly below 91 kt. However, based on the images, the height and the speed were estimated to be 95 ft and 79 kt.



Photo 2.16.6 Images at the time of Takeoff Climbing on the Past Flight of the Aircraft  
(July 22, 2015)

Table 2.16.6-1 Specific Setting of the Flight on July 22, 2015 and Estimated Conditions

Estimated Takeoff Weight	1876 kg
Estimated Takeoff Time	14:30
Wind	14:00 210 degrees, 15 to 18 kt 15:00 210 degrees, 15 kt
Outside Temperature	14:00 33 °C 15:00 32 °C
Head Wind Component at 14:30	9 kt
Takeoff Ground Roll Distance	580 m
Passing Obstacle 50 ft distance	820 m

Table 2.16.6-2 Result of the Analysis of the Images Taken on July 22, 2015

Estimated height at the time of passing the threshold	95 ft
Estimated distance from point of starting the takeoff roll to the threshold	790 m
Estimated speed at the time of passing the threshold	79 kt

## 2.17 Information concerning the Operating and Maintenance Condition of the Aircraft

According to the materials from the company which contracted for the maintenance and administration of the Aircraft by the owner, the operating status and others of the Aircraft was as follows:

(1) Annual flight time: according to the airworthiness inspection records, flight time of the Aircraft over the last four years are as follows:

May 1, 2014 to May 1, 2015: 52 hours 23 minutes

May 2, 2013 to May 1, 2014: 32 hours 09 minutes

March 28, 2012 to May 2, 2013: 73 hours 29 minutes

February 10, 2011 to March 28, 2012: 106 hours 51 minutes

(2) Destinations of the flight: based on the restored flight records, which were damaged due to the fire after the crash, the main destinations are as follows:

2015: Chofu local, Okadama, Fukushima, Shizuoka, Kagoshima

2014: Chofu local, Okadama, Fukushima, Shizuoka

2013: Chofu local, Sapporo, Sado, Oshima, Yao, Kouchi, Amami

2012: Chofu local, Okadama, Fukushima, Sado, Oshima, Oki

## 2.18 Additional Information

### 2.18.1 Takeoff Ground Roll Distance and Takeoff Distance in Calculation

From the performance table (Attachment 3-1 to 3-4) of POH/AFM, the result of calculating the Takeoff Ground Roll Distance\*<sup>4</sup> and Takeoff Distance\*<sup>5</sup> are shown as follows. For the calculation, the temperature is set at 34 °C as same as that at the accident time, no wind, and the takeoff weight at 1,950 kg which is the maximum takeoff weight.

(1) 0° flaps Takeoff

The Takeoff Ground Roll Distance: Approximately 2,230 ft (approximately 680 m)

The Takeoff Distance: Approximately 3,200 ft (approximately 976 m)

(2) Short Field Takeoff (at 20° flap)

The Takeoff Ground Roll Distance: Approximately 1,730 ft (approximately 527 m)

The Takeoff Distance: Approximately 2,700 ft (approximately 823 m)

Based on Performance Table, it is possible to calculate a takeoff distance and a takeoff ground roll distance to a takeoff weight up to the maximum takeoff weight. However, if the weight exceeded the maximum takeoff weight, it is not possible to calculate these distances. Moreover, even if it is assumed that it was flying at the maximum takeoff weight, the takeoff ground roll distance based on the flight manual of the Aircraft is shorter than the runway length of the airport (800 m), but the takeoff distance was exceeding it.

According to the aircraft manufacturer, one should use the takeoff performance table for 0° flap, following the 0° flap takeoff procedures, because the takeoff performance using 10° flap is not different from the performance in the case of using 0° flap.

### 2.18.2 Regulations concerning Takeoff Weight

Pursuant to the Provision of Paragraph 3 of Article 10 of the Civil Aeronautics Act “Airworthiness certification shall describe the categories of aircraft use and aircraft operating limitations”, and pursuant to the provision of Paragraph 2 of Article 11 of the Civil Aeronautics Act “No person may operate an aircraft beyond the categories of its use or operating limitations as designated in the airworthiness certificate”. In addition, pursuant to the provision of Paragraph 2 of Article 12-3 of Ordinance for Enforcement of the Civil Aeronautics Act, aircraft operating limits shall be matters of limitations of

---

\*<sup>4</sup> “Takeoff Ground Roll Distance” means a horizontal distance from the standing point to start a takeoff to the takeoff point.

\*<sup>5</sup> “Takeoff Distance” means a horizontal distance required to take-off and climb to a specified height (50 ft for Category N) above the take-off surface



aircraft, under the airworthiness examination guidelines (Ku-Ken No.381, enacted on October 20, 1966) for aircraft of Aeroplane Normal N (hereinafter referred to as “Category N”) as airworthiness categories which is corresponding to the accident aircraft, maximum weight shall be matters of the limitations in flight manual. As described in 2.14.1(2), maximum takeoff weight is described in flight manual of the Aircraft as limitations.

As described in 2.6.1, the airworthiness category of the Aircraft fell under Category N, and most privately owned airplanes flying over Japan fell under this category. This airworthiness category means “an aircraft with a maximum certified takeoff weight of 5,700 kg or less that is suited for normal flight (turns which do not exceed 60 degrees in bank angle and stall (except a whip stall)) according to Annex 1 of the Ordinance for Enforcement of the Civil Aeronautics Act “Standards regarding structures and performance to ensure the safety of aircraft and components” (hereinafter referred to as the “Aircraft Standards”).

Most airplanes using the Airport fall under Category N, but the airworthiness category of the aircraft used by air carriers who operate the regular service to and from remote islands fall under Aeroplane Transport C (hereinafter referred to as “Category C”). According to the Aircraft Standards, Category C means “multiple engine airplane with a maximum takeoff weight of 8,618 kg or less that is suited for operations for air transport services (limited to aircraft with 19 or less seats except that for a pilot).

Regarding takeoff performance of Category N in the airworthiness design standards (hereinafter referred to as the “Airworthiness Standards”), which set the requirements to show the compliance of the Aircraft Standards, it is required to set a Takeoff Distance and describe it as performance data in a flight manual.

On the other hand, Category C is required to determine the acceleration-stop distance, \*<sup>6</sup> takeoff path\*<sup>7</sup> and takeoff distance / takeoff roll distance as takeoff performances and stipulate them, except takeoff path, as performance information in the flight manual. Moreover, it is required that the flight manual of the category shall contain the description of the maximum takeoff weight determined by applied with acceleration-stop distance, takeoff distance, takeoff roll distance and the like, which is determined depending on the runway length in use.

Moreover, as described in 2.8.1, the provision of Article 73-2 of the Civil Aeronautics Law and Paragraph 1 of Article 164-14 of the Ordinance for Enforcement

---

\*<sup>6</sup> “Acceleration-stop distance” is the whole distance from a standing start point to the point where the aircraft rejects a take-off and comes to full stop.

\*<sup>7</sup> “Take-off path” extends from a standing start point to a point at a height where the transition from the take-off configuration to the enroute configuration must be completed.

of the Civil Aeronautics Act obligate that the pilot in command shall be required to confirm that the aircraft has no problems for flight regarding Takeoff weight, landing weight, location of the C.G., and weight distribution.

In case of Aircrafts used for air transport services, air transport operators-are required to follow the Operation Manual which has obtained approval from the Minister of Land, Infrastructure, Transport and Tourism, however, in “Detailed Guideline of Examination of Operation Manuals (KuKoNo.78, enacted on January 28, 2000)”, a notice issued by the Director of Flight Operation Division, the Aviation Safety and Security Department of Civil Aviation Bureau, which serves as the criteria for granting approval of the manual prescribes that as the items for confirming takeoff weight as stipulated in Article 164-14 of the Ordinance for Enforcement of the Civil Aeronautics Act, which is required for preparing flight plans and determining whether or not to take off as provided for in Article 73-2 of the Civil Aeronautics Act.

### Chapter 3 Operation Manual Examination Standard (Part 2)

(an aircraft of maximum takeoff weight being 5,700 kg or less (except))

(Omitted)

#### 2. *Implementing method of a flight management*

##### 2-5 *Flight management standard*

*As criteria to plan and change a flight, the following matters shall be determined appropriately.*

##### *(1) Planning of Flight Plan and Decision whether to depart or not*

##### *f. Takeoff Weight, Landing Weight, C.G. position and Balance*

*(a) Takeoff weight and landing weight onto a dry runway which are amended and calculated based on height of airport to be used, surrounding obstacles, gradients of runway and others and weather condition shall be complied with the following conditions.*

*Furthermore, for the conditions of wet, snow and ice, calculate to include safety margins, appropriately. (If Flight Manual provides requirement, follow the requirement.)*

*a. Takeoff weight and landing weight shall not exceed the maximum weight as performance provided in Flight Manual.*

*b. Aircraft shall be the weight which requires takeoff distance to be less than effective length of runway or landing strip (hereinafter referred to as “the runway and others”).*

*c. to d* (Omitted)

(2) *The C.G. position shall be within an allowable range.*

The aircraft did not have any applicable Operation Manual since it was a private aircraft, however, as described in 2.14.1 and 2.14.4, Section 2 “Limitations” of the flight manual of the Aircraft has descriptions of “Note; See Section 5 “Performance” for operating limitations of a maximum weight” and the paragraph of Section 5; Performance has mentions with “To obtain the performance from Performance table, do not forget to follow the procedure written in the Figure (Omitted) and “*Apply the departure airport conditions and takeoff weight to the appropriate “Takeoff Ground Roll and Takeoff Distance (omitted)” to determine the length of runway necessary for the takeoff and/or obstacle clearance.*”

### 2.18.3 Statements concerning the Captain

(1) Statements of the instructor when the captain obtained a flight instructor certification

According to the instructor, the captain had a good sense of control as a pilot. Besides, the instructor remembers that the captain was honest, a good listener and was quick to understand. However, the instructor also felt that the captain seemed eager to obtain a flight instructor certification even though he did not have much flight experience. Moreover, during the training, the instructor thought that as the captain did not have enough experience as an air carrier pilot, he lacked the experience to make judgments on his own in piloting. As the nature of the flight instructor certification, how to teach is more important than the sense of piloting, and instructing trainees while flying is quite difficult. The captain seemed to have hard time in different situations to conduct training while controlling the flight from the unfamiliar right seat.

The captain was a type of pilot who complied with checklists and manuals. The instructor also stated that the captain surely must have prepared detailed flight plans.

(2) Statement of the person who has experience of flying the PA-46-350P

According to the person who has experience of flying the PA-46-350P, he saw the captain landing an aircraft at the airport on a windy day, a few days before the accident. He had conversations with the captain about his good piloting on such a day, but the person told that he himself would not fly in such bad weather conditions.

(3) Statement of the maintenance engineer who was a co-worker of the captain at his previous company

According to the maintenance engineer who was a co-worker of the captain at his previous company, he thought that the captain knew the weight and balance at the time of the accident, as the captain used to calculate the weight of the aircraft for each flight. On the other hand, he said that the captain was overconfident and might have thought he would be able to fly even an over-weight aircraft.

#### 2.18.4 Premature Nose-up at the Time of Takeoff

(1) “Airplane Flying Handbook” (FAA-H-8023, chapter 5 Takeoffs and Departure Climbs) issued by FAA includes the following descriptions (Excerpts):

*After rotation, the slightly nose-high pitch should be held until the airplane lifts off. Rudder control should be used to maintain until the airplane lifts off. Rudder control should be used to maintain the track of the airplane along the runway centerline until any required crab angle in level flight is established. Forcing it into the air by applying excessive back-elevator pressure would only result in an excessively high-pitch attitude and may delay the takeoff. As discussed 5 earlier, excessive and rapid changes in pitch attitude result in proportionate changes in the effects of torque, thus making the airplane more difficult to control.*

*Although the airplane can be forced into the air, this is considered an unsafe practice and should be avoided under normal circumstances. If the airplane is forced to leave the ground by using too much back-elevator pressure before adequate flying speed is attained, the wing’s AOA may become excessive, causing the airplane to settle back to the runway or even to stall.*

(Omitted)

*V<sub>x</sub> is the speed at which the airplane achieves the greatest gain in altitude for a given distance over the ground. It is usually slightly less than V<sub>y</sub>, which is the greatest gain in altitude per unit of time. The specific speeds to be used for a given airplane are stated in the FAA-approved AFM/POH. The pilot should be aware that, in some airplanes, a deviation of 5 knots from the recommended speed may result in a significant reduction in climb performance; therefore, the pilot must maintain precise control of the airspeed to ensure the maneuver is executed safely and successfully.*

(Omitted)

*The pilot must always remember that an attempt to pull the airplane off the ground prematurely, and to climb too steeply, may cause the airplane to settle back to the runway or make contact with obstacles. Even if the airplane remains airborne,*

*until the pilot reaches VX, the initial climb will remain flat, which diminishes the pilot's ability to successfully perform the climb or clear obstacles.*

*The objective is to rotate to the appropriate pitch attitude at (or near) VX. The pilot should be aware that some airplanes have a natural tendency to lift off well before reaching VX. In these airplanes, it may be necessary to allow the airplane to lift-off in ground effect and then reduce pitch attitude to level until the airplane accelerates to VX with the wheels just clear of the runway surface.*

(2) “Airplane Operation Textbook” supervised by the Civil Aviation Bureau (Japan Civil Aviation Promotion Foundation, March 31, 2009, p90) has following descriptions;

*“Keeping the takeoff attitude established during the takeoff roll, lift the airplane smoothly. If you force to takeoff by adding an excess back pressure before the aircraft reaches the lift-off speed, it might result in high nose-up attitude to reduce the speed and could result in a stall. The stall at the takeoff causes serious effects to the airframe and human life.”*

#### 2.18.5 Flying on the “Backside”

For an aircraft in level flight at a constant speed, as the speed is slower, drag (air resistance) becomes lower. However, the drag becomes higher below the speed ( $V_x$ ) at which the ratio between lift and drag becomes the maximum. Because thrust corresponds to drag, the thrust needs to be increased as the speed decreases in order to maintain level flight below  $V_x$ , that is, the engine power must be increased. The high speed side of  $V_x$  is called “the front side” and the low speed side is called “the backside”.

During the flight on the front side, pitching up the nose from the level flight while keeping engine power constant causes a decrease of the speed and the aircraft starts to climb. This means that a part of the excess engine power due to the decrease of the speed was directed to cause climbing.

On the other hand, if a similar maneuver is carried out during the flight on the backside, the aircraft descends at the same time as the speed is decreased. This is because the power becomes insufficient to maintain a level flight due to the decreased speed. This kind of characteristics is sometimes called “the backside characteristics”.

In pilot training, the subject called “slow flight” is intended to have trainees obtain the maneuvering sense during the flight on the backside. However, if a speed is decreased unintentionally to the level entering into the backside, pitching up to climb may result in rapid loss of speed and height. In order to escape from the backside, it is necessary to lower the nose and increase the speed, but in order to avoid losing the height, it is also necessary to increase the power at the same time.

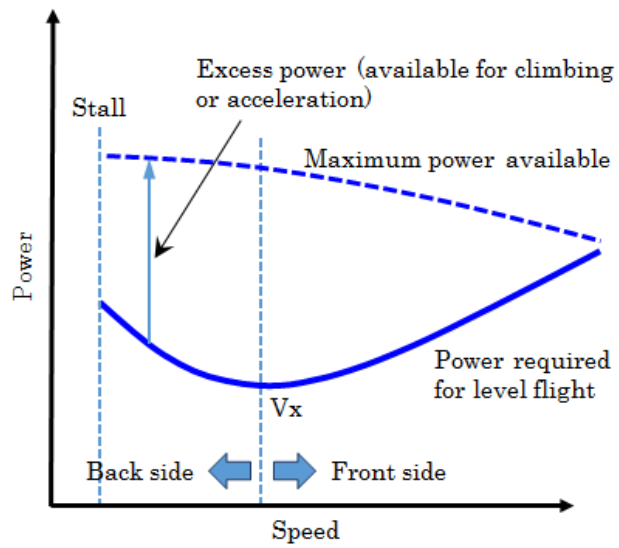

Figure 2.18.5 Speed and Thrust at Backside

## 2.18.6 Safety Measures upon Landing and Takeoff of Aircraft at the Airport Facilities

Airport facilities must be constructed based on the provision of Article 79 of the Ordinance for Enforcement of the Civil Aeronautics Act (hereinafter referred to as the “construction standards”). The Civil Aviation Bureau provides matters for determining the position, forms, strength and others required for facilities from the perspective of securing functionalities, safety, economy and others when designing airport facilities, and also prepares a manual of the standards for constructing airport facilities (hereinafter referred to as the “manual of the construction standards”) as an explanatory document concerning the construction standards with the aim of achieving the efficiency and improvement in the facility design and construction.

### (1) Overrun areas

According to the manual of construction standards, a runway is defined as a rectangular part provided for departure and arrival of aircraft and overrun areas are stipulated as facilities provided on both ends of the runway in preparation for the case where aircraft fails to stop within the runway or other cases.

### (2) International standards and current status in Japan regarding runway end safety areas

In order to mitigate the damage to the aircraft in the event of “Overrun”, which means that an aircraft stops after passing the end of the runway upon landing or taking off, or “Undershoot”, which means that an aircraft lands before the runway, runway end safety areas need to be established at both ends of the landing strip, including overrun areas, based on Annex 14 to the Convention on International Civil Aviation (hereinafter referred to as “the Convention”).

At most airports in Japan, 40 m-long runway end safety areas have been secured. The provisions of Annex 14, which were in a form of a recommendation, were revised in 1999 and became the Standard, which requires extension of the length of runway end safety areas to 90 m for runways of 1,200 m or more in length or instrument landing runways. \*8

Therefore, the Civil Aviation Bureau revised the manual of construction standards in April 2013 requiring the improvement of runway end safety areas based on Annex 14, in principle. Regarding airports where the length and width of runway

---

\*8 “Instrument landing runway” is a runway for landing of aircraft using guidance (a flight completely depending on instruments in measuring attitude, altitude, location and course of the aircraft). Instrument approach is carried out completely depending on instruments such as NDB, VOR, DME, RNAV, ILS and others, and has two types: precision approach and non-precision approach.

end safety areas are not secured, the Bureau decided to evaluate the current status concerning the factors that may lead to accidents and an extent of the damage in the event of an accident, and take measures such as introducing an arresting system\*<sup>9</sup> and securing runway end safe areas, if the effects of those factors are evaluated to be significant.

(3) Overrun areas and runway end safety areas at the Airport

The Airport has the overrun areas of 60 m in length and 30 m in width on both ends of the runway based on the manual of the construction standards. The strength of the pavement at the overrun areas is weaker than that on the runway.

According to the manual of construction standards revised in April 2013, runway end safety areas that are 90 m or more in length (or preferably 120 m or more, if possible) and 60 m in width with 5% or less gradient in vertical and horizontal directions are required to be installed at the end of the overrun areas at an airport for instrument landing even if it has an 800 m-long runway. According to the aerodrome provider and administrator (Tokyo Metropolitan Government), the land for runway end safety areas was reserved as of the time of the accident, but the current status evaluation (interim) as runway end safety areas was incomplete. The current status evaluation was completed in March 2017 and it was concluded that if the land corresponding to runway end safety areas is maintained and operated, there will only be little damage to the aircraft in the event of an accident and no factor leading to occurrence of an accident is found.

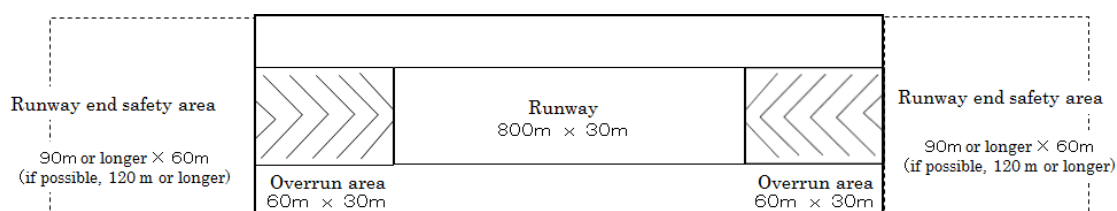

Figure 2.18.6-1 Runway, Overrun Area and Runway End Safety Area of the Airport

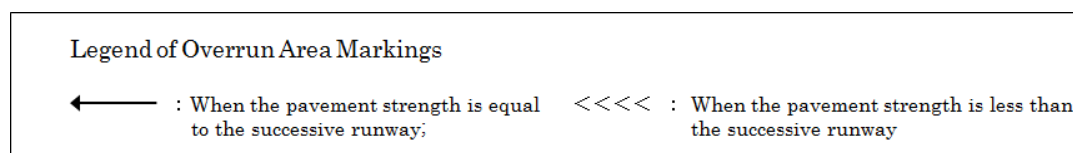

Figure2.18.6-2 Legend of Overrun area markings

\*<sup>9</sup> “Arresting system” means a mechanism to reduce the speed of an overrunning aircraft and mitigate damage thereto. It is an alternative measure when the length or width of a runway end safety area cannot be secured. However, the arresting system is a countermeasure for overrun, not for undershoot.



(4) Measures to make maximum use of a runway length

In Japan, there are cases where entrance taxiways are connected to extensions of runway as seen in Osaka International Airport and others, and enable a maximum use of runway length in comparison to typical airports where entrance taxiways are vertically connected to runway thresholds.

a Case of a airport to Connect Entrance Taxiways to Extensions of Runway

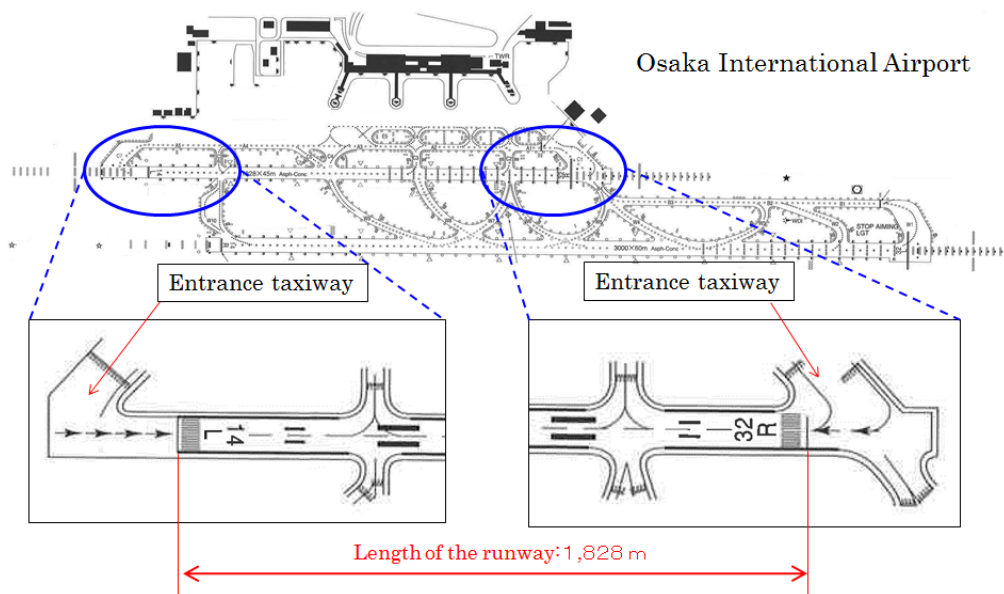

Figure 2.18.6-3 Case of Osaka International Airport

b Case of a General Airport to Connect Entrance Taxiways vertically to runway thresholds

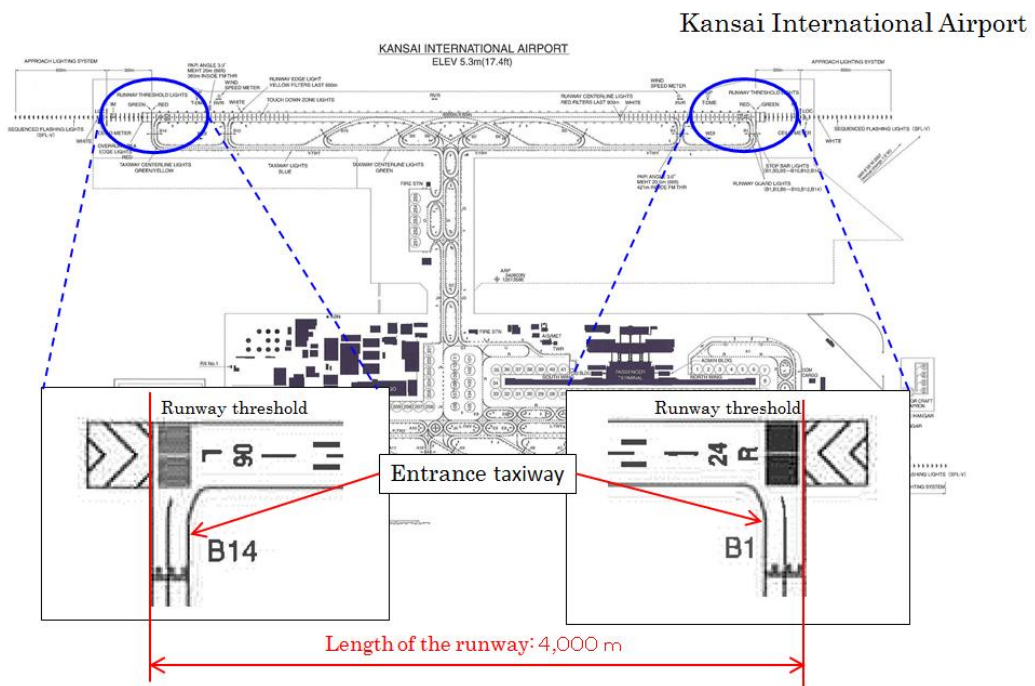

Figure 2.18.6-4 Case of Kansai International Airport

#### 2.18.7 Status of the Maintenance Management of the Aircraft

According to the person in charge at the company which had provided the service to maintenance and management of the Aircraft, he checked the records of the maintenance work whenever a maintenance engineer provides maintenance services. As far as the company found during checks on the Airplane on the ground, there were no anomalies. The company did not think that the Aircraft had conducted flights with malfunctions.

As for the engine power data, when the RPM and manifold pressure show correct values during a test flight, it is determined that there is no problem. Regarding TIT, if other data show correct values, it is tend to be judged as no problem. Regarding trouble shooting, the company told that they might make inquiries directly to the manufacturer or via an agent when they could not fix malfunctions, but they seldom closely examined the data obtained through test flights. They were not aware of low values of TIT gauge as there were no reports about it from the maintenance engineer.

#### 2.18.8 Status of Implementation of the Airworthiness Directive

The contents and the implementation status of the Airworthiness Directive regarding TIT gauge corresponding to the Aircraft were described as follows:

As the purpose to prevent malfunction leading to a loss of aircraft control because a generator damaged due to inappropriate calibration of TIT gauge indicating system and probe defects, the Airworthiness Directive TCD-5111-2000 (hereinafter referred to as “the TCD”) was issued on 2000, which was fully revised to the Airworthiness Directive TCD TCD-5111-2011 (hereinafter referred to as “the revised TCD”). Implementing status of the revised TCD on April 25, 2014 at the total flight time of 2,208 hours and 38 minutes of the Aircraft, the probe was replaced. According to the maintenance records following the TCD and the revised TCD, the probe was inspected for three times and the probe was replaced for six times. In addition, the TCD and the revised TCD were issued by the Civil Aviation Bureau based on the relevant AD 2011-06-10 and AD 99-15-04 R1, incorporated with the Aircraft Manufacturer’s Service Bulletin No.995 and the latest revision to it.

#### 2.18.9 International Standards, Oversea Regulations and Reference Cases

(1) Standards and Recommended Practices of Parts II (International General Aviation – Aeroplanes) of Annex 6 to the Convention on International Civil Aviation

The Standards and Recommended Practices of Parts II (International General Aviation – Aeroplanes) of Annex 6 to the Convention on International Civil Aviation

have the following requirement as international standard regarding the confirmation by the pilot-in-command before departure.

*2.3.1.3 The pilot-in-command shall determine that aeroplane performance will permit the take-off and departure to be carried out safely.*

(2) Regulations set forth by the Federal Aviation Administration of United States of America

The Federal Aviation Regulations have the following requirements regarding the confirmation by pilot in command before departure:

*91.103 Preflight action*

*Each pilot in command shall, before beginning a flight, become familiar with all available information concerning that flight. This information must include-*

(Omitted)

*b) For any flight, runway lengths at airports of intended use, and the following takeoff and landing distance information:*

*For Civil Aircraft for which an approved Airplane or Rotorcraft flight manual containing takeoff and landing distance data is required, the takeoff and landing distance data is required, the takeoff and landing distance data contained therein;*

(3) Regulations of the Civil Aviation Authority (United Kingdom)

The Air Navigation Order 2009 of United Kingdom stipulates the following requirements: regarding the confirmation by pilot in command before departure:

*PART 10*

*Duties of commander*

(Omitted)

*Commander to be satisfied that flight can be safely completed*

*87. The commander of a flying machine must, before take-off, take all reasonable steps so as to be satisfied that it is capable of safely taking off, reaching and maintaining a safe height and making a safe landing at the place of intended destination having regard to –*

*(a) the performance of the flying machine in the conditions to be expected on the intended flight; and*

*(b) any obstruction at the places of departure and intended destination and on the intended route.*

In addition, “SAFETYSENSE LEAFLET 7c AEROPLANE PERFORMANCE”

January 2013 issued by the Civil Aviation Authority concerning small aeroplane performance has the following descriptions (abstract):

(a) *Introduction*

*The pilot in command has a legal obligation under EU Part-NCO and Article 87 of the Air Navigation Order 2009, which require the pilot to check that the aeroplane will have adequate performance for the proposed flight.*

(b) *TAKEOFF-POINTS TO NOTE*

*a Decision point: You should work out the runway point at which you can stop the aeroplane in the event of engine or other malfunctions, e.g. low engine rpm, loss of airspeed, lack of acceleration or dragging brakes. Do NOT mentally programme yourself in a GO-mode to the exclusion of all else.*

*b Use of available length: Make use of the full length of the runway; there is no point in turning a good length runway into a short one by doing an 'intersection' takeoff.*

(4) Report\*<sup>10</sup> issued by the Australian Transport Safety Bureau (hereinafter referred to as the ATSB)

According to the report issued by the ATSB, among events that occurred from January 1, 2000 to January 1, 2010, and are reported to the ATSB, 242 cases were partial power loss of small aeroplanes after takeoff (including 9 death cases) and 75 cases were engine malfunction after takeoff (no death case).

Major contents of "Avoidable Accidents No.3 Managing partial power loss after takeoff in single-engine aircraft" are outlined as below.

*This ATSB booklet aims to increase awareness among flying instructors and pilots of the issues relating to partial power loss after takeoff in single-engine aircraft.*

*Most fatal and serious injury accidents resulting from partial power loss after takeoff are avoidable. This booklet will show that you can prevent or significantly minimise the risk of bodily harm following a partial or complete engine power loss after takeoff by using the strategies below:*

*a Pre-flight decision making and planning for emergencies and abnormal situations for the particular aerodrome*

*b producing a thorough pre-flight and engine ground run to reduce the risk of a partial power loss occurring*

*c taking positive action and maintaining aircraft control either when*

---

\*<sup>10</sup> Details of the report concerning "managing partial power loss after take-off in single-engine aircraft" issued, studied and investigated by the Australian Transport Safety Bureau are publicized on the ATSB website (<http://www.atsb.gov.au>).

*turning back to the aerodrome or conducting a forced landing until on the ground, while being aware of flare energy and aircraft stall speeds.*

*Examples of the causes of engine power loss include, but are not limited to:*

- a mechanical discontinuities within the engine*
- b restricted fuel or air flow or limited combustion in the engine, often due to fuel starvation, exhaustion or spark plug fouling*
- c mechanical blockage in the engine setting controls, such as a stuck or severed throttle cable.*

*A partial engine power loss presents a more complex scenario to the pilot than a complete engine power loss. Pilots have been trained to deal with a complete power loss scenario with a set of basic check and procedures before first solo flight. (Omitted) in a partial power loss, pilots are faced with making a difficult decision whether to continue flight or to conduct an immediate forced landing.*

*By extending already established procedures dealing with total power loss to a partial engine power loss scenario, this report will present the different options to consider during your pre-flight planning.*

- a pre-flight planning (which focuses on preparing for loss of power)*
- b avoiding a partial power loss after takeoff*
  - operations on the ground (preventing loss of power)*
  - the pre-takeoff self-briefing*
  - on takeoff checks and rejecting the takeoff.*
- c managing a partial power loss after takeoff (planning considerations and maintaining control)*
  - forced or precautionary landing (on or beyond the air field)*
  - turning back towards the departure aerodrome.*

#### *Summary*

- (a) Pre-flight checks prevent partial power loss*

*ATSB occurrence statistics indicate that many partial power losses could have been prevented by thorough pre-flight checks. Some conditions reported as causing partial power loss after takeoff are fuel starvation, spark plug fouling, carburetor icing and pre-ignition conditions. In many cases, these conditions may have been identified throughout the pre-takeoff and on-takeoff check*

*phases of the flight sequence.*

*(b) Pre-flight planning and pre-takeoff briefings*

*Even if a partial power loss does occur after takeoff, considering actions to take following a partial power loss after takeoff during the process of planning and the pre-flight safety brief gives pilots a much better chance of maintaining control of the aircraft, and helps the pilot respond immediately and stay ahead of the aircraft. Considerations include planning for rejecting a takeoff, landing immediately within the aerodrome, landing beyond the aerodrome, and conducting a turnback towards the aerodrome.*

*(c) Stay in control*

*If nothing else, maintain glidespeed and plan a maximum bank angle against your personal minimums, which you will not exceed if a turnback is an option. Be prepared to re-assess the situation throughout any maneuver.*

(5) Leaflets by the Civil Aviation Authority of New Zealand (hereinafter referred to as the “CAA”)

According to the materials of the CAA, during the time from January 1, 1995 to December 31, 2012, the CAA received reports of 59 cases of partial power loss (including 3 deaths and 12 persons with serious injuries). Among these, a little over 30% occurred during the time of taking off and climbing. Categorizing the causes of occurrences, mechanical malfunction was 55%, piloting 11%, icing 9%, fuel related 6% and other causes or unknown 19%.

Major contents of the VECTOR May/June 2013 Partial Power issued by the CAA are outlined as follows, indicating the countermeasures against engine power loss:

*(a) Preflight Planning*

*By considering the many factors involved in the takeoff, such as wind strength and direction, runway direction, terrain and obstacles, and landing options on and off the airfield, you will reduce the mental workload required to handle a loss of power. This can also help you with decision making under stress or a high workload in an emergency.*

*Getting this plan together before you leave, will give you the confidence to carry out timely and positive actions if required.*

*(b) Preflight Checks and Inspection*

*The preflight inspection is a vital action for any flight and can reduce the likelihood of a partial power loss occurring after takeoff.*

(Omitted)

*Ensure the engine starts easily and runs smoothly, and allow an*

*adequate warm-up time.*

*Conducting a thorough engine run-up is an important step.*

*Testing fuel flow from the selected tank (fullest or takeoff tank), checking for correct operation of the carburetor heat control, and checking and comparing individual magnetos for a specified RPM drop range is vital. Engine oil temperature and pressures, fuel pressure and other engine or systems gauge indications should be within accepted aircraft operating limitations.*

*Allow plenty of time to conduct the engine run-up check to help show any abnormalities with both the engine and fuel system, and never attempt to take off when the engine continues to misfire or is running rough.*

*(c) Fuel*

*Fuel starvation, exhaustion, or contamination, also rate highly as causes of partial power often leading to total power loss.*

*(Omitted)*

*(d) Induction Icing*

*(Omitted)*

*(e) Pre-flight Self-briefing*

*All single-engine aircraft pilots, just like multi-engine aircraft pilots, should 'self-brief' before each and every takeoff. It helps you keep ahead of the aircraft, and keep control.*

*This brief is generally conducted once all engine and systems checks are complete, just prior to the holding point for takeoff. It serves as a reminder of your planned actions in the event of an emergency.*

*Here is an example of a self-brief:*

*a Engine failure before rotation point, I will abort the takeoff, close the throttle, and stop on the remaining runway.*

*b Engine failure after rotate, runway remaining, I will lower the nose, close the throttle, land in the remaining runway available.*

*c Engine failure in initial climb, I will lower the nose, close the throttle, select the best option, and execute trouble checks if time permits.*

*On the takeoff run, we wisely choose to use the full length of the runway available, and on application of full power we check the static RPM to confirm engine performance.*

*With the brakes off we check the acceleration of the aircraft, and the performance of the engine for any signs of power loss and/or rough running.*

*After rotation and in the initial climb, any partial engine power loss that*



*degrades performance to the extent that you cannot maintain height can be treated as a complete engine failure with a potentially extended glide distance.*

*At this point, you might hear your instructor reminding you to, “lower the nose to the gliding attitude, maintain speed, carry out trouble checks if you have time, and fly the aircraft to a landing.”*

(Omitted)

*At a reasonable height, and with power that is sufficient to maintain height, a turn back to the recently departed runway may be an option, but it has a number of considerations attached. The overriding thought is that the engine could fail at any time.*

*Accidents occur when control is lost, especially when the pilot attempts to turn back to the runway at low level and low speed, or does not maintain control in the glide.*

#### 2.18.10 Actions Taken by the Civil Aviation Bureau (Japan) after the Accident

The Civil Aviation Bureau took following measures after the occurrence of the accident.

Monday, July 27, 2015:

The Civil Aviation Bureau published a notice to the operators of small aircrafts requesting them to take every possible measure of operation for reliable implementation of checking and maintenance and to comply with regulations and procedures.

Wednesday, August 26 to Thursday, August 27, 2015:

In order to confirm the implementation status of the notice issued on July 27, officers of the Civil Aviation Bureau conducted a temporary safety audit targeting nine operators based in Chofu City.

Friday, August 28, 2015:

The aerodrome provider and administrator (Tokyo Metropolitan Government) and the Civil Aviation Bureau established a conference regarding aircraft safety at Chofu Airport and held meetings. It was decided that information regarding the result of the safety audit and the studies of safety actions should be shared and safety measures should be discussed and carried out in full cooperation.

Tuesday, September 1 and Wednesday, September 2, 2015:

Officers of the Civil Aviation Bureau confirmed the status of the Airport after resuming of commercial flight operation.

Thursday, November 26, 2016

Officers of the Civil Aviation Bureau held seminars to promote safety in maintenance work for small aircrafts at Yao Airport. Following this, seminars were also held in Chofu, Sendai, Nagoya, Tokyo and other places.

#### 2.18.11 Actions Taken by the Aerodrome Provider and Administrator (Tokyo Metropolitan Government) after the Accident

(1) On Tuesday, August 18, 2015, the aerodrome provider and administrator (Tokyo Metropolitan Government) held a briefing targeting nearby residents and provided information of the Aircraft, and explained the developments leading to the accident, the actions it has taken as the aerodrome provider and administrator and the future actions, as described below:

##### 1) Immediate response

a. Regarding commercial aircraft, the operation will be resumed after a safety check to confirm the safety of the aircraft to be conducted by maintenance engineers with a national qualification, and after a special safety seminar to be provided by lecturers from outside.

Similar safety checks will also be implemented once every 3 months this fiscal year, and after the resuming the operation, a safety seminar will be implemented periodically.

b. Taking special consideration of the fact that it was a privately owned aircraft that caused the accident, owners are continuously requested to refrain from flying their privately owned aircraft until the cause of the accident is cleared and safety measures are put in place.

##### 2) Future actions

Learning a lesson from the accident, the aerodrome provider and administrator will take further safety actions to prevent reoccurrences, while listening to the opinions of local citizens.

a. Verify whether the use of aircraft at the Airport has been appropriate, or not

b. Promote discussions between local cities and the aerodrome provider and administrator (Tokyo Metropolitan Government) regarding the strengthening of safety actions and further improvement of the administrative management of the Airport.

(2) The aerodrome provider and administrator (Tokyo Metropolitan Government) held briefing sessions targeting nearby residents on June 16 (Thursday), 17 (Friday),

and 20 (Monday), 2016 and explained future actions to be implemented as follows.

- 1) A captain, a maintenance engineer, an operation administrator and others are to be obliged to participate in safety seminars. At the same time, the captain of a privately owned aircraft will be required to thoroughly carry out a pre-departure check and make a report to the administration office. Mechanical engineers working at the Airport will be obliged to participate in lectures targeting engineers held by the national government, and checking and maintenance of aircraft must be implemented by those engineers.
- 2) In order to enhance the system of responsibility in the event of an accident or other emergency, it will be required to appoint a person in charge of emergency response for each privately owned aircraft. Persons thus appointed should hold liaison conferences regularly and bear obligation to provide compensation and apology to victims quickly in the event of an accident. Besides, owners of privately owned aircrafts will be obliged to purchase aircraft third party liability insurance. Moreover, the aerodrome provider and administrator (Tokyo Metropolitan Government) will establish a consultation counter to meticulously deal with requests and consultations from victims, and when relief measures are not taken promptly, the aerodrome provider and administrator (Tokyo Metropolitan Government) will responsibly provide aid to victims promptly such as by securing temporary housing or removing damaged houses.
- 3) In order to ensure reasonableness of flights of privately owned aircraft, efforts will be continued to thoroughly disseminate the fact that sightseeing flights are not allowed under the agreements, concluded with the nearby local cities and other new measures to prevent sightseeing flights will also be taken. If any sightseeing flight is found by the privately owned aircraft, the aircraft will not be allowed to use the Airport.
- 4) The Tokyo Metropolitan Government has worked to promote the positive moving out of privately owned aircraft from the Airport based on the agreement concluded with the nearby local cities in 1997; however, seriously considering requests of three local cities and the regional conference of three municipalities around the Airport asking for the elimination of privately owned aircraft from the Airport, the Metropolitan Government will endeavor to reduce the number of privately owned aircraft to the extent possible. For this purpose, the Metropolitan Government will carry out in-detail investigation on the actual status of privately owned aircraft at the Airport and places to relocate them, and promote concrete actions therefor.

5) Excluding the minimal operations of privately owned aircraft for the purpose of taking an airworthiness inspection defined by laws and regulations or keeping one's piloting skill, the Metropolitan Government will continue to request owners to refrain from flying their privately owned aircraft. Upon the first flight, an examinee of a specific pilot competency assessment will be on board to confirm the competence of the pilot.

### **3. ANALYSIS**

#### **3.1 Qualifications of Personnel**

The Captain held both a valid airman competence certificate and a valid aviation medical certificate.

#### **3.2 Airworthiness Certificate of the Aircraft**

The Aircraft had a valid airworthiness certificate and had been maintained and inspected as prescribed.

#### **3.3 Takeoff Weight and Balance of the Aircraft**

As described in 2.6.4, it is highly probable that when the accident occurred, the weight of the Aircraft is estimated to have been approximately 2,008 kg (approximately 4,427.5 lb) and that the Aircraft was heavier approximately 58 kg than the maximum takeoff weight, which was 1,950 kg. Moreover, it is highly probable that the position of the C.G. was +146.0 to +146.5 in. aft of the reference line, and it was close to the aft limit at the time of the maximum takeoff weight.

The takeoff weight and the position of the C.G. were analyzed as below.

##### **3.3.1 Confirmation of Weight and the position of C.G. before Departure**

As described in 2.8.1, the pilot in command was required to confirm the takeoff weight and the position of the C.G. before departure pursuant to the provisions of Article 73-2 of the Civil Aeronautics Act, and Article 164-14 of the Ordinance for Enforcement of the Civil Aeronautics Act.

As described in 2.6.4, the documents and other materials, which shows the captain calculated the weight and the position of the C.G. of the Aircraft before departure, have not been discovered. As described in 2.1.2 (2) and (3), Passengers B and C stated that they were not asked about their weights by the Captain or Passenger

A before the flight.

Judging from the facts above, it is probable that the weight and the position of the C.G. of the Aircraft were not confirmed sufficiently by the Captain before departure.

### 3.3.2 The Captain's Recognition about Takeoff Weight

As described in 2.6.4 and as analyzed in 3.3, it is highly probable that the takeoff weight at the time of the accident exceeded the maximum takeoff weight.

In general, without accurate calculation, it is probable that pilots can estimate the weight of their accustomed aircraft from their experience and expect whether the weight will completely exceed or is likely to exceed the maximum takeoff weight based on the amount of remaining fuel, number of persons on board and other conditions.

As for the situation of the Aircraft weight when the accident occurred, as described in 2.6.4, it is highly probable that the weight of the loaded fuel was approximately 278 kg, approximately 83 % of the total fuel capacity (333 kg). The most recent flight of the Aircraft was also made by the Captain. Therefore, it is probable that he could estimate the fuel weight situation.

It was not possible to determine whether the Captain recognized the weight exceeding the maximum takeoff weight prior to the Accident flight because the Captain died, but it is somewhat likely that he had insufficient understanding of the risks of making flights under such situation and insufficient safety awareness of observing laws, regulations and provisions.

### 3.3.3 Effects of Weight and Balance of the Aircraft

As described in 2.8.2 and 2.14.4(1), if an aircraft exceeding its maximum takeoff weight engages in flight, the aircraft has reduced takeoff and climb performance and cannot take off, climb or cruise as usual.

When the position of the C.G. is close to the aft limit, in the state that nose up is easily to occur, the following effects will be occurred: excessive nose-up attitude at the time of takeoff and during climb, or decreased controllability, stability or flight performance during a low-speed flight which may lead to an unexpected stall. Therefore, it is necessary to maneuver and control aircraft carefully.

### 3.3.4 Deviation from Allowable Ranges for Weight and the Position of the C.G..

The deviation from allowable ranges for the weight and the position of the C.G. is the excess of operating limitations specified in airworthiness certificates. In addition, as described in 3.3.3, the deviation causes takeoff performance or climb performance

to decrease, and controllability, stability or flight performance to decrease, which may lead to a stall during low-speed flight. Therefore flights must never be made under such conditions.

In this accident, it is highly probable that the excess of the Aircraft weight deteriorated the takeoff and climb performance of the Aircraft, and in the state that nose-up was easily to occur because of the position of the C.G. close to the aft limit was leading to the excessive nose-up attitude at the time of takeoff and climb, and decreased controllability, stability and flight performance during a low-speed flight, which brought the Aircraft to a condition easy to stall. It is highly probable that these were the factors that led the Aircraft to take off at low speed, have the excessive nose-up attitude, and enter stall.

The flight manual described in 2.14.5 shows the importance of the weight and the position of the C.G. to be within allowable ranges. The flight manual also describes that calculation of the weight and the position of the C.G. of aircraft are required in order to keep them within allowable ranges and determine allowable loading capacity of fuel or baggage. The flight manual further states that calculation results have to be inspected prior to refueling in order to prevent inadequate loading status. When planning flights, captains must accurately identify the weight of persons, baggage on board and fuel, calculate the weight and the position of the C.G. based on these factors by using calculation documents or other materials, and be sure to confirm that the weight and the position of the C.G. are within allowable ranges. When deviations from allowable ranges occur, captains are required to restrict persons and baggage to be boarded or reduce the amount of fuel so that maintain the weight and the baggage of the C.G. are maintained within allowable ranges before making flights.

In addition, it is probable that in some cases, it may be practically difficult to reduce the amount of fuel once loaded. Therefore the amount of fuel to be loaded should be carefully examined when there is a possibility that the weight of the aircraft is likely to exceed the maximum takeoff weight or the weight restricted from the airplane performance.

### **3.4 Flight of the Aircraft at the Time of the Accident**

The flight route estimated from the flight history described in 2.1.1 and images and other materials described in 2.16.5 was analyzed.

### 3.4.1 Configuration of the Aircraft and Weather Conditions at the Time of the Accident

#### (1) At the Time of Starting a Takeoff Roll

Judging from the statements of Passenger A described in 2.1.2 (1), it is probable that the Aircraft underwent standing takeoff for which the pilot stopped the Aircraft once on the runway, increased engine rotation sufficiently, and started a takeoff roll.

#### (2) Flaps of the Aircraft

Judging from the photos (such as the right wing) shown in Attachments 1-1 and 1-2, which were taken from inside the Aircraft, it is highly probable that the flap setting were 10°.

#### (3) Landing Gear of the Aircraft

As described in 2.16.5.7 (3), the photo taken from inside the Aircraft at 10:57:53 shows that the landing gear warning was lit. As described in 2.7.2 (1), judging from the fact that the landing gear warning is lit when retractable landing gear is being retracted, it is highly probable that the gear of the Aircraft was being retracted at 10:57:53.

#### (4) Weather Conditions

From the aeronautical weather observations for Chofu Airport described in 2.9.2, it is highly probable that temperature was 34°C.

As for the wind situation, judging from the aeronautical observation values for Chofu Airport described in 2.9.2 (1) and the wind data around the time of the accident as described in 2.9.2 (2) and Attachment 4, it is highly probable that it was not a tail wind condition which affected the flight performance of the Aircraft. In addition, judging from the black smoke rose almost vertically as shown on Photo 2.16.5.1 (3)-2, it is highly probable that the wind velocity was almost zero.

### 3.4.2 Comparison of Flight profiles of the Aircraft between at the Time of the Accident and based on flight manual

A comparison is made concerning the flight profiles of the Aircraft between at the time of the accident as described in 2.1.1 and 2.16.5 and based on the flight manual for the Aircraft as described in 2.14. The flight profile based on the flight manual is computed by using the 0° flap takeoff procedures and the short field takeoff procedures as described in 2.14.3 (4) and the takeoff roll distances and the takeoff distances for each takeoff procedure as stated in 2.18.1. The computation is made on the assumption that temperature is 34°C and takeoff weight is the maximum takeoff weight. The comparison of height and speed for these factors is shown on Figure 3.4.2.

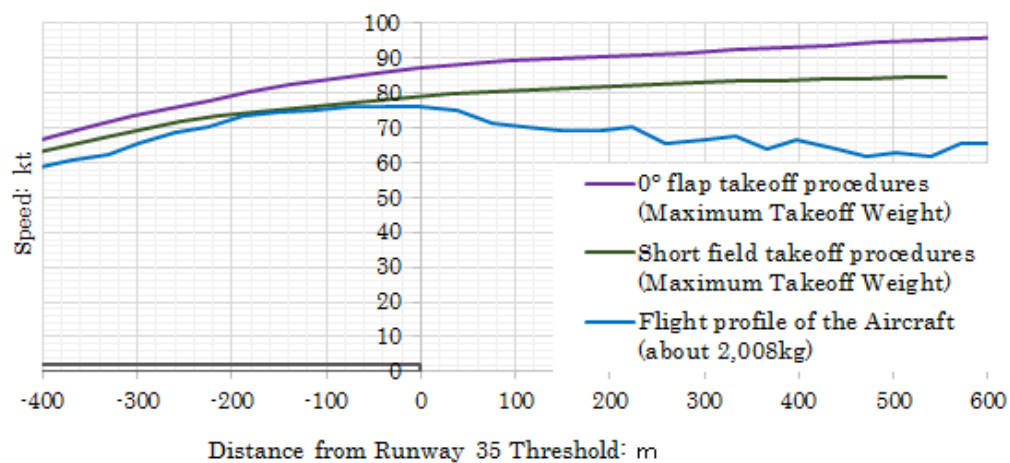
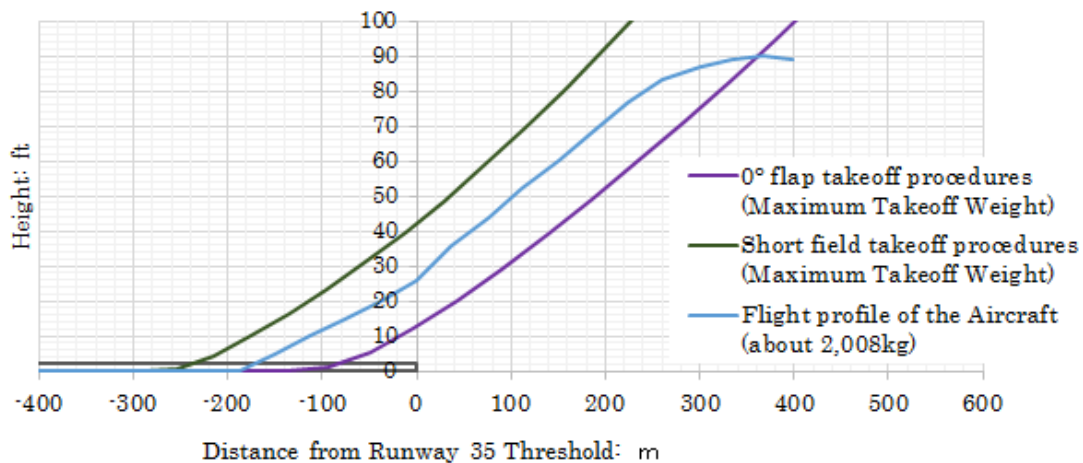

Figure 3.4.2 Comparison of Flight Profile of the Aircraft between at the time of the accident and based on flight manual

### 3.4.3 Takeoff Roll and Takeoff (10:57:13-10:57:41)

The takeoff point of the Aircraft at the time of the accident was approximately 630 m from the Runway 17 threshold as described in 2.1.1. On the other hand, on the assumption that the Aircraft started the takeoff roll at about 10 m from the Runway 17 threshold, from the descriptions stated in 2.18.1, the takeoff point is approximately 537 m from the Runway 17 threshold at the time of the short field takeoff and the maximum takeoff weight, and is approximately 690 m at the time of the 0° flap takeoff.

The flight manual described in 2.14.3 (4) specifies that the lift-off speed is 69 kt for the short field takeoff procedure and is 78 kt for the 0° flap takeoff procedure. It is highly probable that the takeoff speed<sup>\*11</sup> at the time of the accident was approximately 73 kt.

\*11 “Take-off speed” means the speed at which all wheels lift.



Figure 3.4.2 shows increases in speed when the Aircraft had the takeoff roll. It shows that an increase in speed was lower than that for the short field takeoff where flaps are set at 20°. It is somewhat likely that the reason for this is that the takeoff weight of the Aircraft exceeded the maximum takeoff weight as described in 2.6.4; the pitch angle fluctuated up and down at the center of the runway after starting the takeoff roll as described in 2.1.1; and drag increased because the nose wheels lifted at 500 m from the Runway 17 threshold at a speed of approximately 65 kt.

As for the reason why the nose wheels lifted at a speed of approximately 65 kt, judging from the facts that the speed at that time was lower than the lift-off speed determined for the short field takeoff and the pitch angle fluctuated up and down at the center of the runway, it is somewhat likely that the position of the C.G. was near the aft limit as described in 3.3.4.

#### 3.4.4 Speed at the Time of Takeoff

As described in 2.1.1, the Aircraft took off at 10:57:41 at the 630 m point of the runway (remaining distance: 170 m). As described in 3.4.1 (1), judging from the descriptions that the Aircraft stopped on the runway once and then started the takeoff roll, the flaps at that time were set at 10° and the takeoff speed was 73 kt, it is probable that the Captain performed the takeoff procedure at intermediate speed between the lift-off speed of 78 kt for the 0° flap takeoff procedure and the lift-off speed of 69 kt for the short field takeoff procedure as described in 2.14.3(4), performed the short field takeoff procedure at 10° flap takeoff procedure; or he selected the 0° flap takeoff procedure but reacted and took off because the Aircraft was approaching the runway threshold.

#### 3.4.5 State of Climbing just after Takeoff (10:57:42-10:57:54)

As shown in Figure 3.4.2, the climb angle just after takeoff during the flight of the accident was almost the same as those for the short field takeoff and the 0° flap takeoff.

As for the speed at that time, if the climb just after takeoff follows the short field takeoff procedures, the Aircraft is expected to reach 80 kt before flying over 50 ft obstacles, then retract gears and accelerate up to 90 kt while raising flaps. If the climb follows the 0° flap takeoff procedures, the Aircraft is expected to reach 91 kt before flying over 50 ft obstacles.

Figures 2.16.5.3-1 and 2.16.5.3-2 show that the rate of climb was about 500 fpm from just after takeoff to climbing to 80 ft, meaning that the speed was reduced by 5-

10 kt while climbing to 80 ft. The maximum speed after takeoff was approximately 76 kt. The speed was reduced to nearly 70 kt when reaching 80 ft.

It is somewhat likely that in the state that nose-up is easily to occur, because the position of the C.G. was close to the aft limit, the Captain prioritized climbing than speed, or the Captain was too late to recognize the decreased speed because, based on his flight experience with the Aircraft, he thought that it was possible to accelerate and climb even under such climbing situation. However, it was not possible to determine why such flight was continued with the speed decreased because the Captain died.

It is somewhat likely that under the situation just after takeoff, if the Captain prioritized responding to the decreased speed and made the nose down, the speed might not have reduced with decreasing the rate of climb and the flight could have been continued. However, as shown in Figure 2.16.5.3-3, it is probable that the captain continued to climb with excessive nose-up attitude, which decreased the speed, causing the Aircraft to go into the backside flight described in 2.18.5 and reduced the speed at which it was difficult to continue the flight.

#### 3.4.6 Risks of Takeoff Slower than Lift-off Speed

The flaps for the Aircraft were set at 10° at the time of the accident. As described in 2.18.1, there are no differences in takeoff performance between 0° and 10° flaps. In this case, it is probable that the Aircraft must have accelerated up to the lift-off speed determined in the 0° flap takeoff procedure before takeoff.

The lift-off speed for the 0° flap takeoff procedure is determined to be 78 kt. However, the Aircraft took off at approximately 73 kt, a speed lower than that lift-off speed. The Airplane Flying Handbook described in 2.18.4 states that an attempt to take off at low speed and climb too steeply may cause aircraft to settle back to the runway or make contact with obstacles. It is somewhat likely that during the takeoff and climb, it took off slower than lift-off speed and climbed with excessive nose-up attitude in such a way as to decrease the speed, and thereby the Captain could not accelerate sufficiently to reach necessary climb speed. It is probable that these were the factors for the subsequent decrease in height and the crash.

There is a high possibility that changing procedures prescribed in the flight manual based on pilots' own judgments affect operation safety. Such change should never be made.

When it is difficult to accelerate up to the lift-off speed specified for selected takeoff procedure, takeoff must be aborted without hesitation.

### 3.4.7 Situation following climb immediately after Takeoff (10:57:55-10:58:00)

As described in 2.1.1, after reaching height approximately 90 ft, the Aircraft was flying for about five seconds while descending gradually.

It is probable that continuing the climb with excessive nose-up attitude in such a way as to decrease the speed, caused the Aircraft to get into the backside flight and repeated up and down motion of the nose occurred. It is probable that the Aircraft decreased the speed and was about to fall into power-on stall<sup>\*12</sup> condition.

### 3.4.8 Situation from Height Reduction to Crash (from 10:58:00)

As described in 2.1.1, the Aircraft rolled to the left at 10:58:00 and then descended while gliding further to the left. It is probable that the speed just before the Aircraft began to roll was approximately 62 kt. For estimated weight and 10° flaps, the Stall Speed for this model is approximately 66 kt and the power-on stall (at 75 % of maximum power) is calculated to be approximately 62 kt. Judging from these, it is probable that the Aircraft could barely fly until around 10:58:00, but stalled and lost height after that.

Further on that, it is probable that the Aircraft slightly regained speed as the rate of descent increased and it came into shallow descent again just before crash.

As for the fact that the Aircraft veered to the left, it is probable that controlling the Aircraft was difficult as a result that the Aircraft failed to climb and lost speed and that it became unable to completely correct the characteristics of reciprocating single-engine aircraft, which trend to veer to the left, with rudder or other operations.

Judging from the damage situations of the houses A, B, C and D and the situation of the Aircraft after the crash described in 2.4.2, it is highly probable that, just before the crash, the Aircraft made contact with the television antenna of house A and then collided with the roof of house B. After that, the Aircraft crashed onto house D, with its airframe turned upside down, without making contact with house C. From this conditions, it is probable that the Aircraft took a nose-up attitude when it made contact with the television antenna of house A and house B. Judging from the breakage situation of the roof of house B and the damage situation of the body described in 2.11 (1), it is probable that the bottom side of the body crashed onto house B. It is probable that the Aircraft bounded by the impact from the crash, took a forward turn movement with a slight right twist during the bound, crossed over house C and crashed with the airframe upside down.

---

\*12 "Power-on stall" means a loss of speed at high power output.

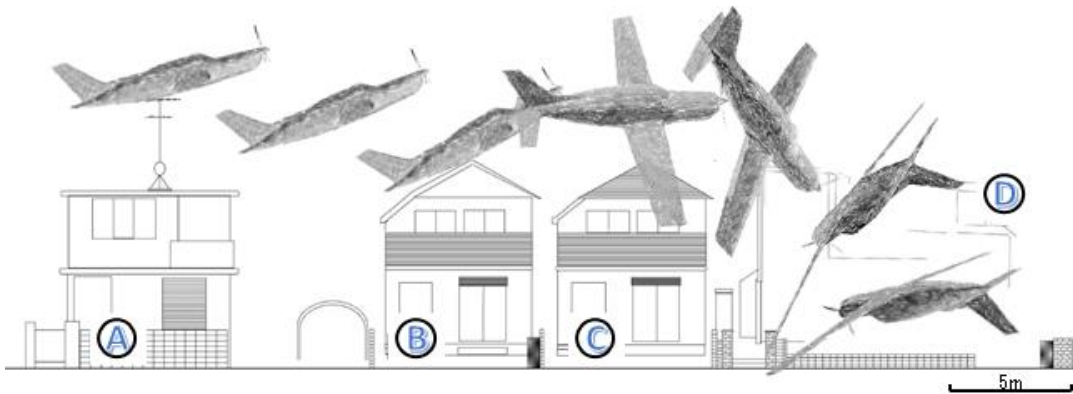

Figure 3.4.8 Estimated Aircraft Movement at the Time of Crash

### **3.5 Analysis based on Mathematical Model**

The flight status of the Aircraft at the time of the accident was reproduced by calculations based on airplane characteristics data (mathematical model) analysis, and was compared with the flight profile of the Aircraft at the time of the accident estimated from images described in 2.1.1 and 2.16.5.

#### **3.5.1 Conditions at the Time of the Accident**

To analyze the flight status of the Aircraft at the time of the accident, when conducting a simulation based on the developed mathematical model, the situation of the Aircraft and the wind conditions at the time of the accident were assumed as below:

##### **(1) Engine Power at Takeoff**

As described in Figure 2.16.5.7-1, the manifold pressure was approximately 39 to 40 inHg from the takeoff roll to after takeoff. Therefore, it was assumed that manifold pressure was 39 inHg as the value which has a big influence on the engine power.

The temperature was assumed to be 34°C as described in 3.4.1 (4). In addition, because the temperature on the runway was 38.1°C when the aviation meteorological observation value was 34°C as described in 2.9.3, the temperature on the runway was assumed to be 38°C at the time of the accident.

The engine power calculated from the performance chart described in 2.15.1 by using these estimated values was 310 HP (89 % of 350 HP, the maximum rated power of the same engine, hereinafter the same applies), and this value was assumed to be the engine power of the Aircraft.

##### **(2) Flap Position**

Because it is highly probable that the flap position was 10° as described in 3.4.1 (2), the flap position was assumed to be 10°.

##### **(3) Wind Conditions**

It is highly probable that the wind at the time of the accident did not affect the flight performance of the Aircraft and that there was almost no wind as described in 3.4.1 (4). Therefore, it was assumed that there was no wind.

### 3.5.2 Mathematical Model of the Aircraft

The mathematical model of the Aircraft was developed to conduct analysis by simulation. The flap position was set  $10^\circ$  as described in preceding paragraphs. The aerodynamic coefficients with landing gears are retracted that was used for simulation is shown in Figure 3.5.2. Parameters other than the aerodynamic coefficient indicated in Figure 3.5.2 are shown in Table 3.5.2. The aerodynamic coefficient and parameters shown in Figure 3.5.2 and Table 3.5.2 were calculated based on the information provided by the manufacturer of the Aircraft and results of the flight test using the type of aircraft.

The airplane characteristics data was developed by reflecting the results obtained from the flight test using the type of aircraft based on the data provided by the manufacturer of the Aircraft and is consistent with the performance value calculated by the performance chart of the

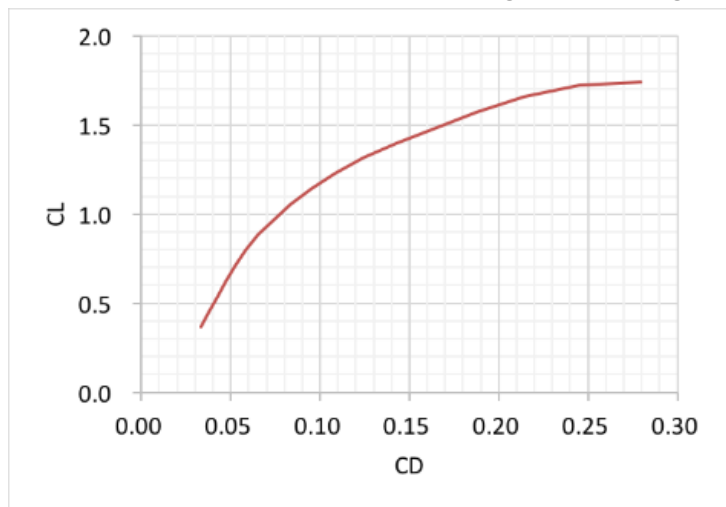

Figure 3.5.2 Relationship Diagram between Lift Coefficient and Drag coefficient

flight manual under the same conditions. However, the obtained airplane characteristics data does not completely match that of the Aircraft as that there can be certain differences among individual aircraft.

Besides, the obtained results do not completely reproduce the flight status of the Aircraft as the attitude and speed in the flight of the Aircraft estimated from images described in 2.1.1 and 2.16.5 contain errors (mainly variation in values).

Table 3.5.2 Mathematical Model and Calculation Elements

Parameter	Numerical Value
Coefficient of rolling friction	0.045
Increment of drag coefficient by extending landing gears	0.023
Profile drag component of drag coefficient	0.025
Ground effect <sup>*13</sup>	Induced drag: decreased by 50 % at 0 ft in height decreased by 0 % at 25 ft in height
Aircraft mass	2,008 kg
Atmospheric density	1.14
Wing area	16.3 m <sup>2</sup>

### 3.5.3 Comparison at Takeoff Ground Rolls

The Aircraft stopped on the runway and started the Takeoff Ground Roll after raising the engine RPM sufficiently as described in 3.4.1. As it is highly probable that the flap position was set to be 10° as described in 3.5.1, it was compared with the takeoff procedure at the 0° flap position during the takeoff ground roll. The test using the type of aircraft verified that there was very little difference between 0° and 10° flap positions in accelerating performance when applying the same procedure.

The heights and speeds of the Aircraft at the time of the accident and based on the 0° flap takeoff procedure by simulation are shown in Figure 3.5.3.

---

\*13 “Ground effect” is the phenomenon that induced drag is reduced and the rate of the change of the lift coefficient against the change of the attack angle increases as the situation of air flow around wings change due to the influence of the ground when an aircraft is flying just close to the ground. Normally, when the flight attitude is less than about the wing span, ground effect is thought to be observed. In this case, as the lift drag ratio increases due to decreasing induced drag, the required thrust or the required horsepower for the flight is small when the weight of the aircraft is the same.

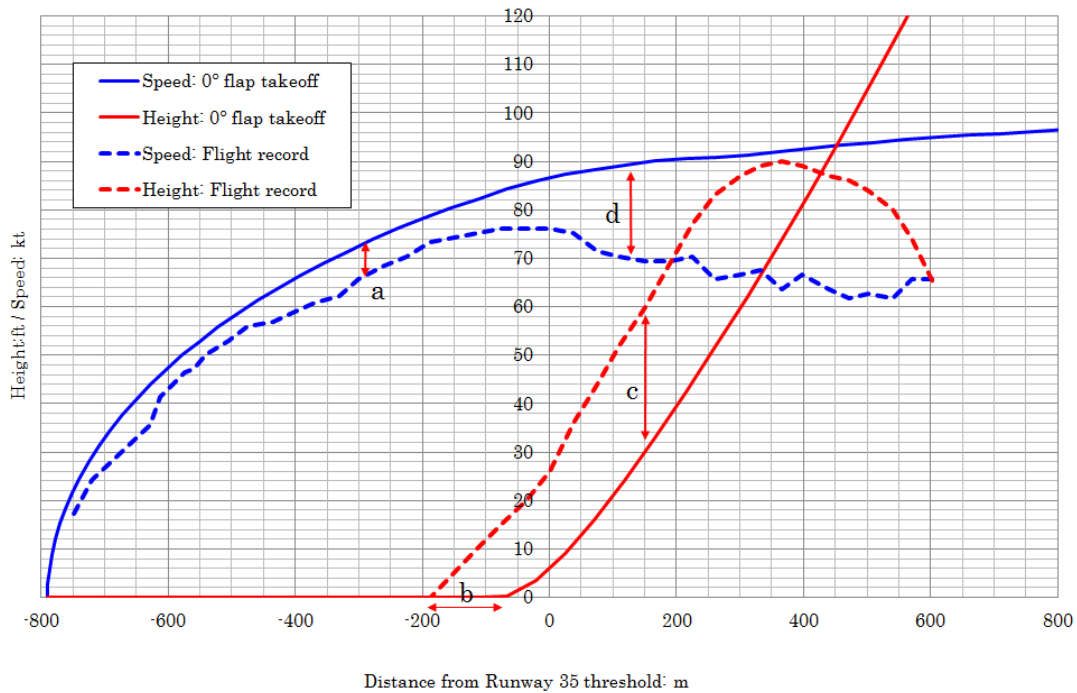

Figure 3.5.3 Comparison at the Takeoff Ground Rolls (0° Flap Takeoff and the Takeoff of the Aircraft)

The flight of the Aircraft has noticeable differences as compared with the profile of the 0° flap takeoff in the following two points:

- Slower acceleration at the takeoff ground roll (two-way arrow a in Figure 3.5.3)
- Earlier take-off (lower take-off speed) (two-way arrow b in Figure 3.5.3)

Based on the Takeoff Ground Roll distance of the 0° flap takeoff calculated from the performance chart of the flight manual described in 2.18.1 and comparison between the lift-off speed at the 0° flap takeoff of the flight manual and the flight profile of the Aircraft at the time of the accident described in 2.14.3, the thrust and engine power during the Takeoff Ground Roll were estimated.

The Takeoff Ground Roll Distance at the 0° flap takeoff is the distance from where start of takeoff to where the main landing gear completely floats when the nose of the Aircraft begins to rise at 78 kt; the speed at takeoff is 80.5 kt. Based on the estimated flight profile at the time of the accident, assuming the Aircraft continued to run to the point of 720 m where it is supposed to take off at the 0° flap takeoff, the speed at the point was estimated to be 75.2 kt. The average acceleration was calculated under the assumption that acceleration during the Takeoff Ground Roll was constant. Then, the calculated average acceleration was converted to thrust and power. These



values are shown in Figure 3.5.3.

Table 3.5.3 Estimation of Engine Power during the Takeoff Roll

State	Distance: 720 m Speed at arrival (kt)	Average acceleration (m/s <sup>2</sup> )	Converted to thrust (%)	Converted to power (%)
0° flap takeoff	80.5	1.19	100	96
Takeoff of the Aircraft	75.2	1.04	87	78

It is found that the average acceleration at the takeoff of the Aircraft was 87 % of the value at the 0° flap takeoff. Assuming this difference of the acceleration is caused by decrease in thrust, the engine power was calculated to be 78 % (275 HP) based on the performance chart of propellers.

#### 3.5.4 Simulation at Takeoff and Climb

A simulation of the takeoff and climb of the Aircraft was conducted to match the climb path by using the mathematical model of the Aircraft. In this simulation, the engine power and flap setting of the Aircraft at the time of the accident assumed in 3.5.1 were used. In addition, the simulation was conducted under the assumption that landing gear began to be retracted when the height exceeded 60 ft.

The simulation results when controlling an aircraft to match the climb path of the Aircraft are shown in Figure 3.5.4.

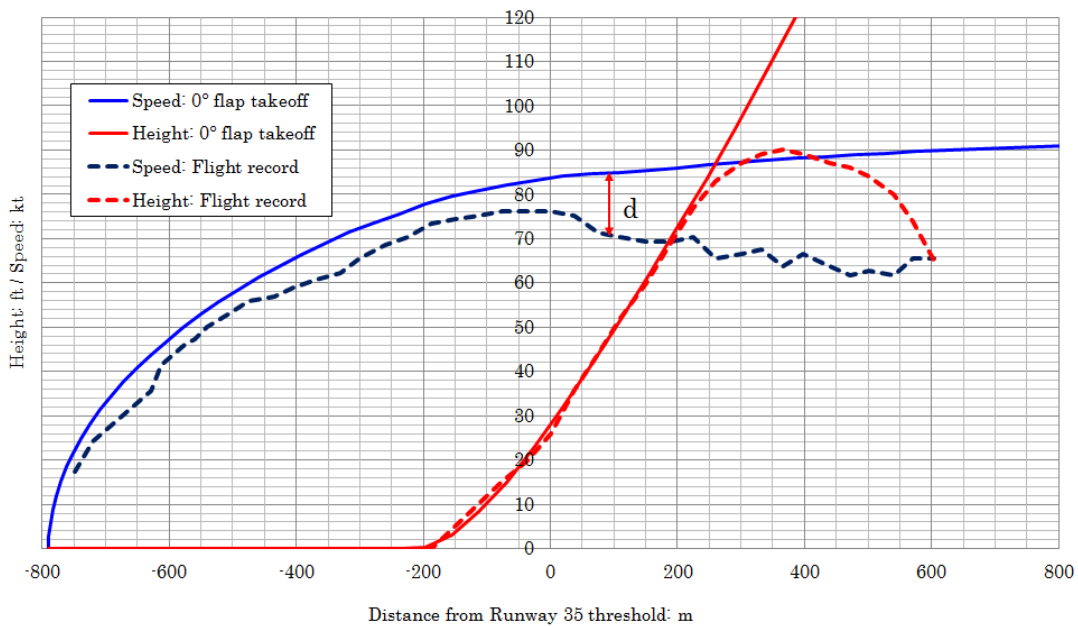

Figure 3.5.4 Comparison with the Simulation When Matching the Climb Path

As shown in these two figures, the flight of the Aircraft has noticeable differences at the takeoff climb path as compared with that of the simulation in the following two points:

- Larger climb angle (two-way arrow c in Figure 3.5.3)
- Decelerating during climb (two-way arrow d in Figures 3.5.3 and 3.5.4)

On the other hand, the results of the simulation show that an aircraft will not decelerate and is supposed to accelerate to climb after the height exceeds approximately 90 ft even if it retraces the same climb path of the Aircraft at the time of the accident at the engine power assumed in 3.5.1 as shown in Figure 3.5.4.

The Aircraft took off at 10: 57: 41 and continued to climb for approximately 10 seconds. The climb rate during this time was 400 to 450 fpm and 3.0° to 3.5° when converted to path angles. In addition, the speed decelerated by five to 10 kt in approximately 10 seconds.

The climb performance of the Aircraft with the landing gears extended at 10° flap and a speed of 70 kt was calculated from the aerodynamic coefficient and propeller performance chart of the type of aircraft, and the resulting values are shown in Figure 3.5.4. No ground effects were taken into consideration in this calculation.

Table 3.5.4: Estimation of Engine Power after Takeoff

Power (HP)	Climbing performance (fpm)	Converted to path angles (°)
335	590	4.6
310	520	4.0
280	420	3.3
220	190	1.4

The flight path angle of the Aircraft during climb is nearly the same as the climb performance at 280 HP. However, it is probable that the average power during climb was lower than that as the Aircraft was decelerating during this time.

### 3.5.5 Flight during Shallow Descent

The Aircraft was further decelerating as it was gradually descending from 10:57:55 to 10:58:00. Video images showed that the pitch angles repeatedly changed as described in 2.1.1. In addition, it is highly probable that pitch angles repeatedly changed within the range of a few degrees considering the relationship between the height and speed at this time described in 2.16.5.3. The speed during this time was 65 to 70 kt, and it is probable that the Aircraft was flying backside described in 2.18.5.

The results of calculations of engine power which is required for the Aircraft to perform horizontal flight with the landing gear up are shown in Figure 3.5.5. It is somewhat likely that there are errors of about 0.02 in drag coefficient and about 20 HP in power as accurate data on drag was not obtained in particular, 65 kt and 70 kt are near stalling speed.

Table 3.5.5 Engine Power Required for Horizontal Flight

Speed (kt)	Power (HP)
65	190 (54 %)
70	160 (46 %)
75	135 (39 %)
80	125 (36 %)

It is somewhat likely that the power of the Aircraft which could not maintain horizontal flight at the speed of 65 to 70 kt was 190 HP or less as described in Table 3.5.5. It is somewhat likely that large errors will occur in calculations that assume

balanced steady state because the movement of the Aircraft was highly non-steady especially during this phase.

The analysis based on the mathematical model in 3.5.3, 3.5.4, and this section showed that the flight of the Aircraft (acceleration at takeoff, climb path, climb performance, and speed during climb) could be reproduced, assuming there was a decrease in engine power. Therefore, it is somewhat likely that the engine power of the Aircraft at the time of the accident decreased.

### **3.6 Analysis on Engine Power of the Aircraft**

As analysis using the mathematical model described in 3.5 showed the probability of decreased engine output of the Aircraft, factors that are likely to give influence on engine power were analyzed.

Factors that decrease engine power include flying operation, environmental influence such as outside air temperature, and engine malfunction.

#### **3.6.1 Decreased Engine Power due to Flying Operation**

Influence of flying operation that leads to decreased engine power includes throttle operation and the use of the air conditioner.

##### **(1) Influence of Throttle Operation**

As described in 2.16.5.7, the manifold pressure of the Aircraft during the takeoff roll and takeoff climb was approximately 39 to 40 inHg according to the manifold pressure gauge in the image taken within the Aircraft. As mentioned in 3.5.1 (1), it is assumed that the engine power at this time was 310 HP (89 %). The engine power is approximately 331 HP if manifold pressure is 42 inHg under the same condition. Therefore, it is probable that engine power decreased by approximately six percent because of low manifold pressure.

For throttle operation at the start of the takeoff roll, some pilots may set manifold pressure slightly low in order to prevent overboost by the rise of manifold pressure when the aircraft speed increases.

The manifold pressure of the Aircraft was approximately 39 to 40 inHg. It was not possible to determine whether this manifold pressure of approximately 39 to 40 inHg was set by the throttle operation of the Captain or caused by other factors since the captain was dead.

##### **(2) Influence of the Use of Air Conditioner**

According to the statements of the Passengers described in 2.1.2, it is highly probable that the air conditioner was operated after the engine start. If the checklist

of the flight manual was observed, the air conditioner might turned off before takeoff. On the other hand there is some possibilities that the air conditioner was continuously used during takeoff.

As described in Attachment 6, the teardown inspection of the air conditioner, the use of an air conditioner decreases engine power by approximately one percent, and the result of the teardown inspection showed that it was not possible to determine the influence since the use of the air conditioner during takeoff was not able to be identified based on the adhesion situation and the heat situation of the refrigerant oil the Aircraft crashed upside down and was influenced by the subsequent fire.

### 3.6.2 Influence of Outside Air Temperature

According to the aeronautical weather observations described in 2.9.2, the temperature at Chofu Airport around the time of the accident was 34°C. In addition, as described in 2.9.3, it is probable that the outside air temperature over the runway was approximately 38°C when observed temperature was 34°C. As described in 2.15.1, when the outside air temperature is high, the performance of engine deteriorates. Compared to the case of the standard atmosphere (15°C), it is highly probable that engine power decreased by approximately 3.4 % and approximately 4 % when the outside air temperature was 34°C and 38°C, respectively.

As previously mentioned, when the outside air temperature is high, engine power decreases. The influence of outside air temperature has been reflected in the performance table of the flight manual shown in Attachment 3-1 to 3-4; therefore, by checking this, it is possible to confirm the influence of outside air temperature on flight in advance. The analysis described in 3.5 also included the influence of outside air temperature.

### 3.6.3 Possibility of Decreased Engine Power Due to Other Factors

Based on the failure mode (malfunction) resulting in engine malfunction, the situation of the Aircraft at the accident, and the subsequent investigation result, the possibility of the occurrences of engine power decrease was verified.

Table 3.6.3 shows failure modes resulting in engine malfunction in relation to this accident, and instruments possibly indicating abnormal values when each failure mode occurs or items for which abnormality will be found by the conducted tests and others are marked with ○.

Table3.6.3 Failure Mode Resulting in Engine Malfunction

	Failure mode/instruments indicating abnormal values	Manifold pressure	Fuel flow	Engine RPM	Sound	Vibration	Exhaust gas color	Teardown inspection
Fuel system	Obstruction (from pump to regulator)		○					
	Obstruction (from regulator to distributor)		○					
	Obstruction (from distributor to nozzle)							○
	Obstruction (nozzle)							○
	Failure of engine driven fuel pump		○					
	Contamination of water			○	○	○		
	Contamination of foreign matters							
	Improper fuel/air ratio	○	○					
	Operation of the mixture lever by the pilot		○					
	Injector maladjustment							
Combustion	Detonation						○	○
Induction system	Turbocharger malfunction	○						
	Throttle operation by pilot	○	○					
	Obstruction/break of induction pipe (between valve and distributor)	○						○
	Obstruction/break of induction pipe (between distributor and cylinder)							○
	Failure of induction valve							
	Cam failure							

Oil pressure	Decrease of oil pressure								○
Exhaust system	Break of exhaust pipe								○
Ignition system	Plug non-ignition (wet fouling, wear)								○
	Magneto malfunction								
Other	Failure of piston rod and other mechanical parts								○

(1) Malfunction of Fuel System

Figure 2.16.5.7 (1) shows that the value of the fuel flow indicator at the start of the takeoff roll was normal, and as a result of the engine teardown inspection after the accident described in 2.16.1, there was no obstruction in the fuel flow divider. Besides, as described in 2.16.5.6, the results of sound analysis during the flight of the Aircraft revealed that engine rotation was approximately 2,500 rpm, which was the maximum rating. Based on these facts, it is probable that possibility of malfunction of the fuel system was low.

(2) Malfunction of Combustion

As a result of engine teardown inspection after the accident described in 2.16.1, the piston had no sign of early combustion, and evidence of normal combustion was found on the piston head. Therefore, it is highly probable that detonation did not occur.

(3) Malfunction of Induction System

In the case of malfunction of the induction system, it is probable that the manifold pressure gauge indicates abnormal values. However, based on Figure 2.16.5.7 (1), the value of the manifold pressure gauge during the takeoff roll, after takeoff and during gear up indicated 39 to 40 (the maximum value is 42 in), and it is probable that this value cannot be identified as the value in the case of clear

malfunction of the induction system.

(4) Malfunction of Oil Pressure and Exhaust System

With regard to malfunction of oil pressure and the exhaust system, pre-flight check (engine run-up) and engine teardown inspection found no sign of malfunction in any failure mode. Therefore, it is probable that the possibility of the occurrence of these malfunction is low.

(5) Malfunction of Ignition System

With regard to malfunction of the spark plug, checkup before flight and engine teardown inspection found no abnormality, and therefore, it is probable that the possibility of the occurrence of spark plug malfunction is low.

Besides, with regard to malfunction of the magneto, the results of engine teardown inspection after the accident described in 2.16.1 and magneto teardown inspection described in 2.16.3 revealed severe heat damage due to the fire after the accident. Therefore, it was not possible to determine the possibility of occurrence of malfunction.

(6) Other Malfunction

The result of teardown inspection did not reveal any mechanical malfunction related to the power transmission system including the piston rods.

#### 3.6.4 Verification Result of Engine Power

According to the analysis based on the mathematical model described in 3.5, it is somewhat likely that the engine power of the Aircraft decreased.

The engine of the Aircraft was not in the state where evidence or signs showing malfunction of the engine were able to be found due to damage from the impact of crash and the subsequent fire, or there is a possibility that evidence and signs themselves disappeared, however, from the analysis of investigation results related to the engine described in the preceding paragraphs, it was not possible to obtain any results clearly showing the occurrence of engine malfunction; hence, it was not possible to determine that engine power decreased due to factors other than high outside air temperature and low manifold pressure.

#### 3.6.5 Relation between Decrease of Engine Power and RPM

As describe in 3.5, analysis based on the mathematical model showed a possible decrease of engine power. If engine power decreases, as described in 2.7.2 (5), the propeller pitch angle does not become shallower than the minimum value restricted by low pitch stop despite the decrease of engine power, which leads to decrease in



engine RPM itself . The decrease in engine RPM is indicated by the RPM indicator on the instrument panel and is obvious by the change of engine sound, and therefore pilots are able to easily recognize it.

Sound analysis described in 2.16.5.6 revealed that the engine RPM of the Aircraft was maintained at approximately 2,460 rpm until the crash. It is probable that there was no possibility of occurrence of decreased engine power under the situation where engine RPM did not decrease. However, if the low pitch stop setting was lower (shallower) than the specified value, it is somewhat likely that engine RPM did not decrease despite the decrease of engine power.

As described in 2.15.2, Propeller Owner's Manual of propeller manufacturer warns that adjustment of low pitch stop setting to lower value may hide any trouble of engine power. If low pitch stop of the Aircraft was set at a value lower than the specified value, it is somewhat likely that the Captain would not have been able to recognize any decrease of engine power.

The teardown inspection of the engine, propeller and other parts described in Attachment 6 revealed that there was a mark of the propeller pitch angle being 13° to 14° at the time of the crash on the preload plate. Besides, verification of high pitch stop and low pitch stop after the teardown inspection described in Attachment 6 showed that the set value of low pitch stop was likely to be approximately 15°.

However, as shown in the propeller teardown inspection report described in Attachment 6, in the record of overhaul immediately before the said propeller was installed in the Aircraft (the year of 2005), low pitch stop was set at the specified value of 17.6°, as described in 2.6.3 (3), there was no record of adjustment of low pitch stop setting in the subsequent maintenance record, and propeller teardown inspection reports state that “*Although pre-load plate impact marks appeared to be below the low pitch stop setting of 17.6°, they were likely caused by the impact forces and moments forcibly twisting the blades beyond/lower than the low pitch stop setting.*” Therefore, it was not possible to determine whether low pitch stop setting was lower (shallower) than the specified value.

### 3.6.6 Constant Decrease of Value Indicated on TIT Indicator

According to the records of flight tests in the past associated with periodical maintenance work of the Aircraft (Attachment 5), the values indicated on the TIT indicator had been lower than the normal operating range since 2012.

As described in 2.18. 8, the TCD and the revised TCD related to the malfunction to degrade accuracy in values indicated on the TIT indicator was issued applicable to

the TIT probe of the type of aircraft. Besides, the maintenance record of the Aircraft included the record of maintenance work in accordance with the TCD and the revised TCD but did not include the record of corrective work of low values indicated on the TIT indicator at the flight test associated with periodical maintenance work. Therefore, it is probable that the relevant corrective work was not implemented.

Consequently, it is somewhat likely that a full understanding of reasons for and the background to the technical information of manufacturers and others was not reflected in maintenance work and that flight test records after periodical maintenance were not utilized in maintenance work to the full extent.

### **3.7 Preparation for Partial Power Loss of an Engine**

As described in 2.18. 9, for partial power loss of an engine of single-engine aircraft, in foreign countries, especially Australia and New Zealand, the information related to preventive measures and operational reaction for the partial power loss of an engine at takeoff and immediately after takeoff is collected and the results of analyses of the collected information are summarized and published.

The preventive measures and operational reaction for the partial power loss of an engine are summarized as follows;

(Preventive measures)

- (1) Pre-flight planning
- (2) Preflight check and inspection
- (3) Preflight self-briefing
- (4) Training

(Operational action for the partial power loss of an engine)

- (1) Continue flight operation as far as possible for successful landing
- (2) Decide about whether to return to the departure airport

It is probable that safety for flight of small private aircraft can be further improved by positively preparing for an engine failure at takeoff and considering such measures in advance.

### **3.8 Response of the Civil Aviation Bureau of the Ministry of Land, Infrastructure, Transport and Tourism**

The Civil Aviation Bureau of the Ministry of Land, Infrastructure, Transport and Tourism as the safety actions to prevent reoccurrence of this accident , has implemented concrete measures including rechecking of confirmation procedure regarding takeoff

weight and the like before departure for operators of small aircrafts to enforce the thoroughness to observe the laws and ordinances, procedures, has issued the Reminder document to request reports the measures, and has conducted aviation safety seminars where it has planned thorough confirmation before departure by pilot in command. In addition, the Civil Aviation Bureau has strengthened the safety audit for air careers based in Chofu Airport and the educational activities for operators of small aircrafts through the meetings of operators of the Airport, and has enhanced the cooperative relationship with the provider and administrator of airports at/from which small aircrafts arrive/depart (including the provider and administrator of Chofu Airport (Tokyo Metropolitan Government)) through exchange of opinions and information.

It is desirable for the Civil Aviation Bureau to enhance the relationship with the provider and administrator of Chofu Airport (Tokyo Metropolitan Government) through continued exchange of opinions and information, to comprehend progress made in preventive measures by the administrator, and to give advice and guidance for the administrator to ensure effort for preventive measures on a timely basis.

### **3.9 Response of the Provider and Administrator of Chofu Airport (Tokyo Metropolitan Government)**

In an explanation meeting with local residents held on June 2016, the provider and administrator of Chofu Airport (Tokyo Metropolitan Government) explained the safety actions taken after the accident, as follows; thorough confirmation before departure by pilot in command; participation of maintenance engineers of Chofu Airport in workshops for maintenance engineers organized by the national government; mandatory participation of captains, maintenance engineers and aircraft dispatchers in aviation safety seminars to further increase safety awareness; holding of regular meetings for strengthening the system of responsibility during an emergency by checking which organization is responsible at the time of and after an accident, along with the provider and administrator of Chofu Airport (Tokyo Metropolitan Government) plannings concerning a variety of support to provide rapid relief for injured parties, such as actively working on people responsible for dealing with accident aircraft during an emergency in liaison with relevant agencies, implementing a consultation service for injured parties that will respond carefully to their requests and consultations, and securing temporary homes for injured parties and taking responsibility for removal of damaged houses. It is desirable for the provider and administrator (Tokyo Metropolitan Government) to steadily implement these measures.

Moreover, the provider and administrator (Tokyo Metropolitan Government)

appropriately monitors Chofu Airport and the surrounding area to prevent the construction, planting and installation of tall buildings, plants and other structures that affect arrival and departure of aircraft in the area. Furthermore, Chofu Airport has received estimation results stating that, if the current runway end safety area is maintained and used, any damage caused by any aircraft accident can be kept to a minimum and there will be no cause for any accidents. It is probable that damage will be limited to a certain level, even if undershoot and overrun occur at Chofu Airport. Therefore, it is desirable for the provider and administrator of Chofu Airport (Tokyo Metropolitan Government) to notify the operators of information on the runway end safety area at Chofu Airport through AIP or other methods as quickly as possible.

### **3.10 Improvement of Safety**

In this accident, the small private Aircraft crashed into a residential area and caused injury to residents as well as damages to houses around Chofu Airport. In order to prevent from recurrence of this kind of accidents, measures for ensuring and improving operation safety of small private aircraft were considered, as below.

#### **3.10.1 Ensuring Safety of Small Private Aircraft**

It is somewhat likely that the Captain of the Aircraft took off without following the procedure prescribed in the flight manual described in 3.4.6 in excess of maximum takeoff weight and without compliance with requirements for performance prescribed in the flight manual. Compliance with the weight, speed and procedures prescribed in the flight manual is important for operation safety. If the weight and the position of the C.G. are not within the allowable range, the controllability, stability or flight performance of aircraft will be reduced, and flight safety cannot be ensured. In that case, flight must not be undertaken.

The Civil Aviation Bureau of MLIT needs to address the following items to ensure the safety of small private aircraft.

##### **(1) Confirmation before Departure by Pilot in Command**

As described in 2.6.4 and 2.18.1, the Aircraft did not satisfy the requirements for performance prescribed in the flight manual. that is, takeoff distance shall be runway length in use or less, along with exceeding the maximum takeoff weight at the time of the takeoff.

As described in 2.18.2, it is necessary for the captain at the confirmation before departure provided in Article 164-14 of Ordinance of the Civil Aeronautics Act and Article 73-3 of the Civil Aeronautics Act to confirm a fact that not only weight of an

aircraft is within maximum takeoff weight but also it satisfies the requirements for performance prescribed in the flight manual, however, it is probable that the understanding about the importance is not sufficiently instilled among captains of small private aircraft, differing from operators of air transport services who provide the Operation Manual following the Detailed Guideline of Examination of Operation Manuals..

Over the past five years, there have been two fatal accidents involving small private aircrafts affected by inappropriate weight and the position of the C.G. of the aircraft. In this accident, a small private aircraft caused an accident as it took off without satisfying the requirements for performance prescribed in the flight manual as well as exceeding the maximum takeoff weight.

Therefore, it is necessary to promote pilots of small private aircrafts to understand the importance to confirm that requirements for performance prescribed in the flight manual are satisfied, in addition to the importance to comply with maximum takeoff weight and limit for the position of the C.G., as confirmation before departure, at the occasions like specific pilot competency assessments and aviation safety seminars.

Moreover, to prevent confirmation errors made by the captain, and ensure safety flight, it is preferable to request persons with knowledge on aviation to double check the records confirmed by the captain as much as possible.

#### (2) Assumption of Decreased Flight Performance at Takeoff

Along with compliance with the speed and procedure prescribed in the flight manual, as for the actions to the situation of degraded flight performance leading to the situations where the flight could not be continued due to lack of acceleration or decrease in speed during takeoff, it is necessary to enforce instructions and trainings to pilots of small private aircraft to plan the actions in advance including to follow the emergency procedure prescribed in the flight manual and confirm these actions thorough self-briefing by a pilot himself at the time of preparation before departure.

### 3.10.2 Improvement of Safety at Airports

As described in 3.4.4, it is somewhat likely that the Aircraft took off as it was approaching the runway threshold.

As described in 2.18.6 (4), in Japan, there are cases where entrance taxiways are connected to extensions of runways as seen in Osaka International Airport and others, and enable a maximum use of runway length. In this manner, regarding making maximum use of runway length at takeoff, it will allow a pilot to have a margin

to make a decision during takeoff roll and contribute to improving safety, it is necessary to study and compile the cases of effective measures connecting entrance taxiways to runway thresholds in order to make maximum use of runway length and inform aerodrome providers and administrators of these case studies.

### 3.10.3 Measures for Increasing Safety in Small Private Aircraft Maintenance

As described in 2.18.6, the TCD and the revised TCD had been issued to the Aircraft to correct TIT probe failure, which decreased the accuracy of values indicated on the TIT indicator, and the maintenance records of the Aircraft showed that the required measures had been taken. However, this investigation found that the reading of the TIT indicator had been constantly low in the past flight test records.

For this reason, proper maintenance measures should have been applied to deal with the decreased values indicated on the TIT indicator, but it is probable that the measures were not taken. Therefore, it is somewhat likely that a full understanding of the reason for and the background to the technical information of the manufacturers and others was not reflected in maintenance work and that the flight test records after periodical maintenance were not utilized in maintenance work to the full extent.

It is necessary for small private aircraft to be securely maintained based on a proper understanding of technical information. Therefore, appropriate management of technical information and implementation of maintenance work based on the information is important to ensure aircraft safety.

## 4. CONCLUSION

### 4.1 Findings

#### (1) Takeoff Weight and Balance

When the accident occurred, it is highly probable that the weight of the Aircraft is estimated to have been approximately 2,008 kg and that the Aircraft was approximately 58 kg heavier than the maximum takeoff weight, which was 1,950 kg. Moreover, it is probable that the position of the C.G. was +146.0 to +146.5 in. aft of the reference line, and it was close to the aft limit at the time of the maximum takeoff weight. (3.3)\*<sup>14</sup>

It is probable that the weight and the position of the C.G. of the Aircraft were

---

\*14 The number at the end of each paragraph in this section (4. Conclusion) refers to a main subsection number of "3 Analysis" where a relevant description can be found.

not confirmed sufficiently by the Captain before departure. (3.3.1)

It is not possible to determine whether the Captain recognized the fact that the weight of the Aircraft exceeded the maximum takeoff weight before departure, it is somewhat likely that he had insufficient understanding of the risks of making flights under such situation and insufficient safety awareness of observing laws, regulations and provisions. (3.3.2)

If an aircraft exceeding its maximum takeoff weight engages in flight, the aircraft has reduced takeoff and climb performance. Besides, when the position of the C.G. is close to the aft limit, the condition will result in excessive nose-up attitude and decreased controllability, stability or flight performance during a low-speed flight, which may lead to an unexpected stall. (3.3.3)

In this accident, it is also highly probable that the excess of the Aircraft weight deteriorated the takeoff and climb performance, and in the state that the nose-up was easily to occur because the position of the C.G. close to the aft limit, was leading to the excessive nose-up attitude at the time of takeoff and climb, and decreased controllability, stability and flight performance during a low-speed flight, which brought the Aircraft to a condition easy to stall. It is highly probable that these were the factors that led the Aircraft to take off at low speed, have the excessive nose-up attitude, and enter stall.

When planning flights, captains must accurately identify the weight of persons, baggage on board and fuel, calculate the weight and the position of the C.G. based on these factors by using calculating documents or other materials, and be sure to confirm that the weight and the position of the C.G. are within allowable ranges. (3.3.4)

The amount of fuel to be loaded should be carefully examined when there is a possibility that the weight of the aircraft is likely to exceed the maximum takeoff weight or the weight restricted from the airplane performance. (3.3.4)

## (2) Flight of the Aircraft at the Time of the Accident

It is probable that the Aircraft underwent standing takeoff, and it is highly probable that the flap setting were 10°. It is highly probable that the temperature was 34°C and there was almost no wind. (3.4.1)

POH/AFM specifies that the lift-off speed is 78 kt for the 0° flap takeoff procedure, but it is highly probable that the takeoff speed at the time of the accident was approximately 73 kt.

As for the fact of the Aircraft showed the movement of lifting the nose gear wheel at 500 m point from the threshold of the runway 17 with speed of approximately 65 kt, it is somewhat likely that because the position of the C.G. was close to the aft limit.

(3.4.3)

With regard to takeoff at the speed of approximately 73 kt, it is somewhat likely that the Captain performed the takeoff procedure at intermediate speed between the lift-off speed of 78 kt for the 0° flap takeoff procedure and the lift-off speed of 69 kt for the short field takeoff procedure, performed the short field takeoff procedure with the 10° flap setting, or he selected the 0° flap takeoff procedure but reacted and took off because the Aircraft was approaching the runway threshold. (3.4.4)

As for the reasons why a climbing was continued with the speed decreased, it is somewhat likely that in the state that nose-up is easily to occur, because the position of the C.G. was close to the aft limit, the Captain prioritized climbing than speed, or the Captain was too late to recognize the decreased speed because, based on his flight experience with the Aircraft, he might have thought that it was possible to accelerate and climb even under such climbing situation. It is probable that the captain continued to climb with excessive nose-up attitude, which decreased the speed, causing the Aircraft to go into the backside flight and reduced the speed at which it was difficult to continue the flight. (3.4.5)

It is somewhat likely that the Aircraft took off slower than lift-off speed and climbed with excessive the nose-up attitude, which decreased the speed, and thereby the Captain could not accelerate sufficiently to reach necessary climb speed. It is probable that these were the factors for the subsequent decrease in height and the crash.

When it is difficult to accelerate up to the lift-off speed specified for selected takeoff procedures, takeoff must be aborted without hesitation. (3.4.6)

As for the situation following climb immediately after takeoff, it is probable that continuing the climb with excessive nose-up attitude in such a way as to decrease the speed, caused the Aircraft to get into the backside flight, and led it to be about to fell into power-on stall condition. (3.4.7)

It is probable that the Aircraft could barely fly until around 10:58:00, but stalled and lost height after that. It is probable that the Aircraft took a nose-up attitude when it crashed onto a house, bounded by the impact from the crash, took forward turn movement with a right twist during the bound, and crashed with the airframe upside down. (3.4.8)

(3) Analysis based on Mathematical Model

Simulations were conducted by taking account of temperature and manifold pressure at the time of the accident and by calculating engine power from the manual of the engine manufacturer. The results of the simulation showed that an aircraft will



not decelerate and is supposed to accelerate to climb after the height exceeds approximately 90 ft even if it retraces the same climbing route of the Aircraft at the time of the accident. (3.5.4)

Assuming there was a decrease in engine power before the Aircraft started shallow descent, acceleration at takeoff, climb path, climb performance, and speed during climb of the Aircraft was able to be reproduced. Therefore, it is somewhat likely that the engine power of the Aircraft at the time of the accident decreased. (3.5.5)

(4) Analysis on Engine Power of the Aircraft

Factors that decrease engine power include flying operation, environmental influence such as outside air temperature, and engine malfunction. (3.6)

From the analysis of investigation results related to the engine, it was not possible to obtain any results clearly showing the occurrence of engine malfunction, and it was not possible to determine that engine power decreased due to factors other than high outside air temperature and low manifold pressure. (3.6.4)

(5) Response of the Civil Aviation Bureau of the Ministry of Land, Infrastructure, Transport and Tourism

It is preferable for the Civil Aviation Bureau of the Ministry of Land, Infrastructure, Transport and Tourism to enhance the relationship with the provider and administrator of Chofu Airport (Tokyo Metropolitan Government) through continued exchange of opinions and information, to comprehend progress made in preventive measures by the administrator, and to give advice and guidance for the administrator to ensure effort for preventive measures on a timely basis. (3.8)

(6) Response of the Provider/Manager of Chofu Airport (Tokyo Metropolitan Government)

It is desirable for the provider and administrator of Chofu Airport (Tokyo Metropolitan Government) to steadily implement measures explained at the meeting with local residents on June 2016, and notify the operators of information on the runway end safety area at Chofu Airport through AIP or other methods as quickly as possible. (3.9)

(7) Improvement of Safety

It is necessary for the Civil Aviation Bureau of MLIT to promote pilots of small private aircraft to understand the importance to confirm that requirements for performance prescribed in the flight manual are satisfied, in addition to the importance to comply with maximum takeoff weight and limit for the position of the C.G., as confirmation before departure, at the occasions like specific pilot competency assessments and aviation safety seminars.

Furthermore, along with compliance with the speed and procedure prescribed in the flight manual, as for the actions to the situation of degraded flight performance leading to the situations where the flight could not be continued due to lack of acceleration or decrease in speed during takeoff, it is necessary to enforce instructions and trainings to pilots of small private aircraft to plan the actions in advance including to follow the emergency procedure prescribed in the flight manual and confirm these actions thorough self-briefing by a pilot himself at the time of preparation before departure. (3.10.1)

Regarding making maximum use of runway length at takeoff, it will allow a pilot to have a margin to make a decision during takeoff roll and contribute to improving safety, it is necessary to study and compile the cases of effective measures connecting entrance taxiways to runway thresholds in order to make maximum use of runway length and inform aerodrome providers and administrators of these case studies. (3.10.2)

## **4.2 Probable Causes**

It is highly probable that this accident occurred as the speed of the Aircraft decreased during takeoff and climb, which led the Aircraft to stall and crashed into a residential area near Chofu Airport.

It is highly probable that decreased speed was caused by the weight of the Aircraft exceeding the maximum takeoff weight, takeoff at low speed, and continued excessive nose-up attitude.

As for the fact that the Captain made the flight with the weight of the Aircraft exceeding the maximum takeoff weight, it is not possible to determine whether or not the Captain was aware of the weight of the Aircraft exceeded the maximum takeoff weight prior to the flight of the accident because the Captain is dead. However, it is somewhat likely that the Captain had insufficient understanding of the risks of making flights under such situation and safety awareness of observing relevant laws and regulations.

It is somewhat likely that taking off at low speed occurred because the Captain decided to take a procedure to take off at such a speed; or because the Captain reacted and took off due to the approach of the Aircraft to the runway threshold.

It is somewhat likely that excessive nose-up attitude was continued in the state that nose-up tended to occur because the position of the C.G. of the Aircraft was close to the aft limit, or the Captain maintained the nose-up attitude as he prioritized climbing over speed.

Adding to these factors, exceeding maximum takeoff weight, takeoff at low speed and continued excessive nose-up attitude, as the result of analysis using mathematical models, it is somewhat likely that the decreased speed was caused by the decreased engine power of the Aircraft; however, as there was no evidence of showing the engine malfunction, it was not possible to determine this.

## **5. SAFETY ACTIONS**

### **5.1 Safety Actions Taken after the Accident**

#### **5.1.1 Safety Actions Taken by the Civil Aviation Bureau of the Ministry of Land, Infrastructure, Transport and Tourism**

(1) Issuing the reminder document to small aircrafts operators

Immediately after the Accident, concrete measures including rechecking of confirmation procedures regarding takeoff weight and the like in order to enforce the thoroughness to observe the laws and the ordinance procedures were implemented, and the reminder document to request reports regarding the measures were issued.

(2) Thorough Implementation of Confirmation by Captains before Departure

It was decided to put more effort into training sessions to encourage captains to obtain weather information, prepare flight plans (include the confirmation of weight and balance of aircraft), obtain basic knowledge about engine test run and conduct accurate confirmation.

- a Lecturers are dispatched to training sessions for pilots, such as aviation safety seminars, to enhance the quality of these events. In addition, the staff of the Civil Aviation Bureau holds lectures to educate captains about the importance of thorough confirmation and preflight safety inspection. Adding to this, classes are held regarding the necessities to confirm takeoff weight, C.G. position and balance based on the flight manual at these seminars.
- b Leaflets (Include necessities to confirm takeoff weight, C.G. position and balance prior to a departure) are distributed to explain how to ensure the safety of small aircrafts to pilots who will take specific pilot competency assessment given by pilot competency examiners, in order to educate them about flight safety.

(3) Promoting to Conduct Accurate Maintenance by Private Aircraft Maintenance Engineer

At training sessions, the staff of the Civil Aviation Bureau informs and educates private aircraft maintenance engineer about the importance of complying with aircraft manuals, relevant laws and regulations, and of conducting proper maintenance.

(4) Purchase of Aviation Insurance Policy for Private Aircraft

Leaflets are distributed to pilots who will take specific pilot competency assessment given by pilot competence examiners, in order to encourage them to purchase an insurance policy. Adding to this, when private aircrafts use a temporary helipad and national airports, the coverage status of aircraft/pilots is confirmed prior to a flight under conditions of taking-out an aviation insurance (third party liability insurance) in order not to fly without appropriate insurances. And instruct to take the same measures at other airports than the ones managed by a national government.

(5) Provision of Information Services

In order to increase the use of existing flight information services for pilots in flight, materials describing the outline of “TCA advisory service” and “area/en-route information service (AEIA)” were prepared and distributed at training sessions for small aircrafts pilots.

(6) Appropriate Acquisition of Business License

Instructions to acquire a business license were reinforced, and the provision of educational information and information about license acquisition for businesses involving aircraft was enhanced.

- a Educational leaflets about the acquisition of a business license were provided to private aircraft pilots and aircraft owners via regional Civil Aviation Bureaus and industry associations.
- b Measures were taken to make it easier to acquire a business license using flow charts and application forms necessary in business license acquisition procedures.

(7) Deployment of Measures for Business Operators who Use Small Aircraft

Air carrier services and business operators who use small aircraft were also informed of measures (1) and (2) for private aircraft, even though they have clearly stipulated their procedures for confirmation before departure and aircraft maintenance in their operation and maintenance manuals.

(8) Reinforcement of Cooperation with Providers and administrators of Airports where Small Aircrafts Takeoff and Land

- (i) Regular Information Exchange with Airport Managers

- a It was decided that continued discussion with persons in charge of administration of the Chofu Airport associated with the provider and administrator of Chofu Airport (Tokyo Metropolitan Government) will be made.
- b It was decided that discussion with persons in charge of administration of all airport will be held at training sessions provided by the Aerodrome Support and Aeronautical Service every year.

(ii) Training Sessions for Airport Administrators

It was decided that training sessions will be provided (in FY2015) to persons in charge of airports administrated by local government or private organization (including public heliports) to deepen their knowledge about SMS (safety management system) in airports and improve airport safety.

(9) Organizing Operators of Small Aircrafts

It was decided to promote the organization of small aircrafts operators for each airport in order to facilitate communication and thorough implementation of safety measures.

- a Recommendation was made to implement safety information sharing with small aircrafts operators through the Airport Committee at the FY2015 airport manager training session.
- b Through relevant organizations, small aircrafts operators permanently stationed at airports and private aircraft groups were invited to positively participate in the Airport Committee meeting hosted by providers and administrators of airports.

(10) Promotion of measures to take new safety actions and initiatives to raise safety awareness

Civil Aviation Bureau of MLIT regularly holds “Safety Promotion Board relating to small aircrafts and the like” since 2016 and while taking account of opinions expressed by experts and relevant organizations at the board as carrying out investigations and studies relating to establishments of Safety Actions for small aircrafts, and promotes the initiatives to take new safety actions and to raise safety awareness.

5.1.2 Safety Actions Taken by the Provider and administrator of Chofu Airport (Tokyo Metropolitan Government)

- (1) Aiming at the dissemination of and education about safety measures, on January 20, 2016, a safety training session was held for business operators and private

aircraft operators based there (19 companies and 2 individuals). Lecturers were invited from the Civil Aviation Bureau of the Ministry of Land, Infrastructure, Transport and Tourism, air carrier services and the organization of private aircraft operators who were based at Chofu Airport. Participation in the session was on a voluntary basis.

(2) Safety inspection of aircraft was carried out for all 10 business operators who use aircraft for their business and are based at Chofu Airport. Inspection was conducted three times (from July (after the accident) to September 2015, from October to December 2015, and from January to March 2016).

## **5.2 Safety Actions Required by the Civil Aviation Bureau of the Ministry of Land, Infrastructure, Transport and Tourism**

(1) In this accident, small private aircraft crashed into a residential area and caused injury to residents as well as damages to houses, however it is highly probable that the aircraft was flying with exceeding the maximum takeoff weight and without satisfying the requirements for performance prescribed in the flight manual. Therefore, it is necessary to promote pilots of small private aircraft to understand the importance to confirm that requirements for performance prescribed in the flight manual are satisfied, in addition to the importance to comply with maximum takeoff weight and limit for the position of the C.G., as confirmation before departure based on the provision of Article 164-14 of Ordinance of the Civil Aeronautics Act, at the occasions like specific pilot competency assessments and aviation safety seminars.

Furthermore, along with compliance with the speed and procedure prescribed in the flight manual, as for the actions to the situation of degraded flight performance leading to the situations where the flight could not be continued due to lack of acceleration or decrease in speed during takeoff, it is necessary to enforce instructions and trainings to pilots of small private aircraft to plan the actions in advance including to follow the emergency procedure prescribed in the flight manual and confirm these actions thorough self-briefing by a pilot himself at the time of preparation before departure.

(2) As stated in 3.4.4, it is somewhat likely that the Aircraft took off as it was approaching the runway threshold. Regarding making maximum use of runway length at takeoff, it will allow a pilot to have a margin to make a decision during takeoff roll and contribute to improving safety, study and compile the cases of effective measures connecting entrance taxiways to runway thresholds in order to make maximum use of runway length and inform aerodrome providers and administrators of these case studies.

## 6. RECOMMENDATIONS

It is highly probable that this accident occurred as the speed of the Aircraft decreased during takeoff and climb, which led the Aircraft to stall and crashed into a residential area near Chofu Airport.

It is highly probable that decreased speed was caused by the weight of the Aircraft exceeding the maximum takeoff weight, takeoff at low speed, and continued excessive nose-up attitude.

As for the fact that the Captain made the flight with the weight of the Aircraft exceeding the maximum takeoff weight, it is not possible to determine whether or not the Captain was aware of the weight of the Aircraft exceeded the maximum takeoff weight prior to the flight of the accident because the Captain is dead. However, it is somewhat likely that the Captain had insufficient understanding of the risks of making flights under such situation and safety awareness of observing relevant laws and regulations.

It is somewhat likely that taking off at low speed occurred because the Captain decided to take a procedure to take off at such a speed; or because the Captain reacted and took off due to the approach of the Aircraft to the runway threshold.

It is somewhat likely that excessive nose-up attitude was continued in the state that nose-up tended to occur because the position of the center of gravity of the Aircraft was close to the aft limit, or the Captain maintained the nose-up attitude as he prioritized climbing over speed.

Adding to these factors, exceeding maximum takeoff weight, takeoff at low speed and continued excessive nose-up attitude, as the result of analysis using mathematical models, it is somewhat likely that the decreased speed was caused by the decreased engine power of the Aircraft; however, as there was no evidence of showing the engine malfunction, it was not possible to determine this.

In this accident, small private aircraft crashed into a residential area and caused injury to residents as well as damages to houses, however the Aircraft was flying with exceeding the maximum takeoff weight and without satisfying the requirements for performance prescribed in the flight manual, and over the past five years, there have been two fatal accidents involving small private aircraft affected by inappropriate weight and position of the center of gravity of the aircraft ( (1) Mooney M20C, JA3788, which crashed when landing at Yao Airport in March 2016, and (2) Cessna 172N Ram, JA3814, which veered off the runway of Otone Airfield, Kawachi Town, Inashiki-gun, Ibaraki Prefecture, and made a fatal contact with a ground worker in August 2012). In view of

the result of these accident investigations, as operation safety of small private aircraft needs to be improved, the Japan Transport Safety Board recommends the Minister of Land, Infrastructure Transport and Tourism pursuant to Article 26 of the Act for Establishment of the Japan Transport Safety Board to take the following measures:

(1) Promote pilots of small private aircraft to understand the importance to confirm that requirements for performance prescribed in the flight manual are satisfied, in addition to the importance to comply with maximum takeoff weight and limit for the position of the center of gravity, as confirmation before departure, at the occasions like specific pilot competency assessments and aviation safety seminars.

Enforce instructions and trainings to pilots of small private aircraft to plan the actions in advance including to follow the emergency procedure prescribed in the flight manual and confirm these actions thorough self-briefing by a pilot himself at the time of preparation before departure. along with compliance with the speed and procedure prescribed in the flight manual, as for the actions to the situation of degraded flight performance due to lack of acceleration or decrease in speed during takeoff.

(2) Study and compile the cases of effective measures connecting entrance taxiways to runway thresholds in order to make maximum use of runway length and inform aerodrome providers and administrators of these case studies as maximum use of runway length at takeoff, will allow a pilot to have a margin to make a decision during takeoff roll and contribute to improving safety.



Figure 1 Three View Drawings of Piper PA-46-350P

Unit: m

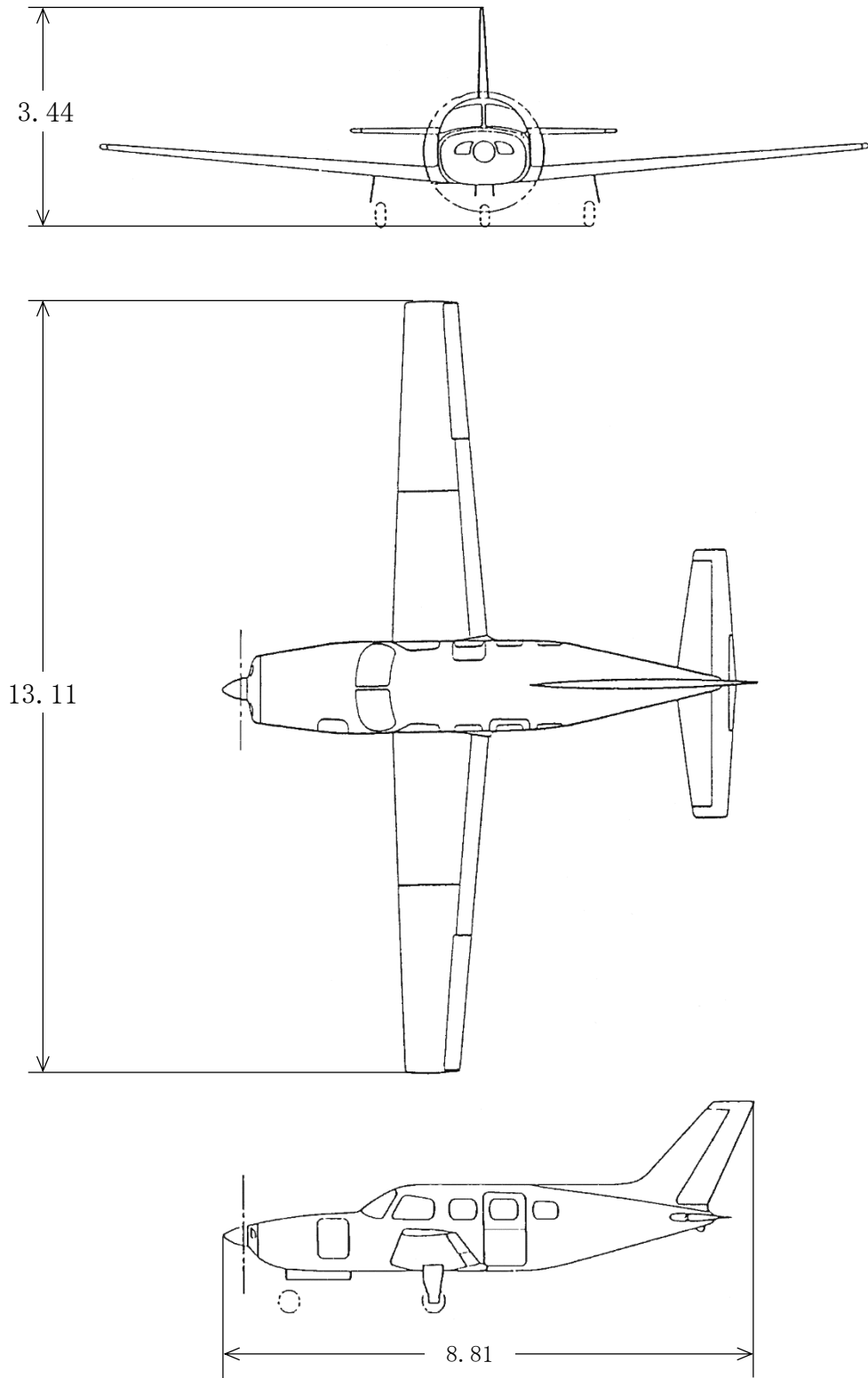
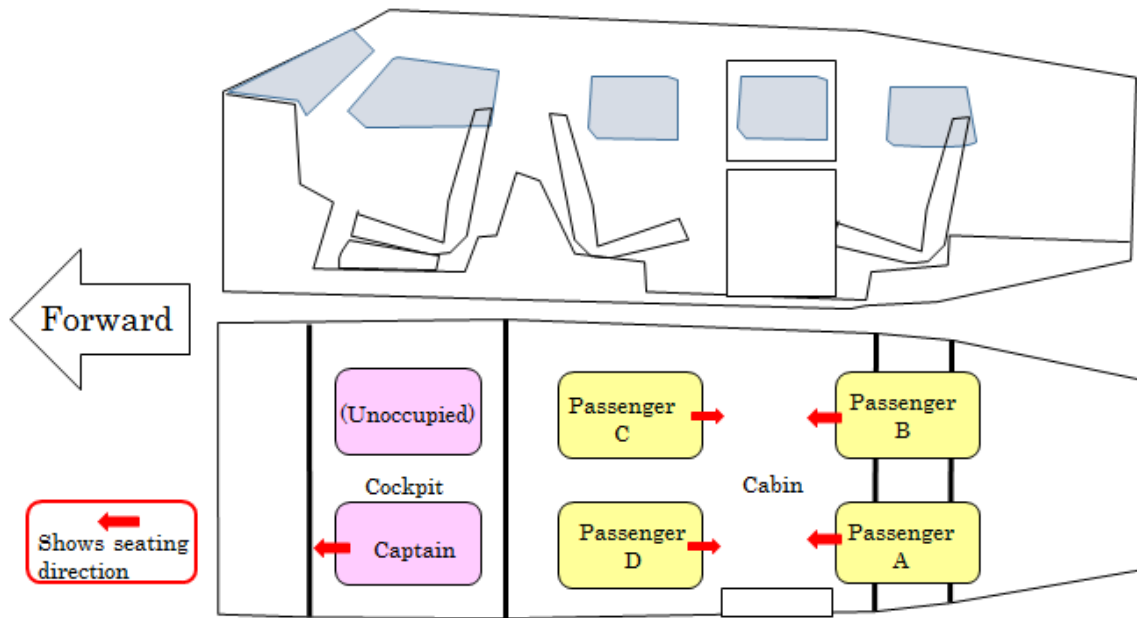

Figure 2 Seating Chart



Attachment 1-1      Photos taken from inside  
of the Aircraft (Right Wing and Flaps) (i)



Photo taken at 10:57:20



Photo taken at 10:57:41



Photo taken at 10:57:42



Photo taken at 10:57:48

Attachment 1-2      Photos taken from inside  
of the Aircraft (Right Wing and Flaps) (ii)

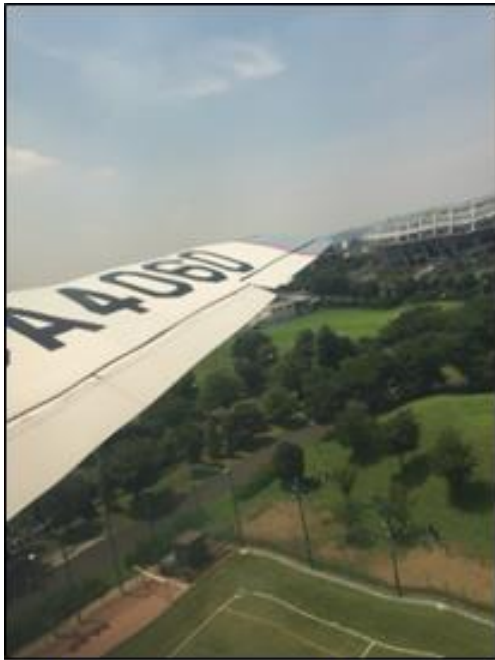

Photo taken at 10:57:55



Photo taken at 10:57:59

Attachment 2      Inside of the Aircraft  
(instrument panel)



Photo taken at 10:45:42



Photo taken at 10:57:22



Photo taken at 10:57:29



Photo taken at 10:57:53

# Attachment 3-1 Performance Chart (Takeoff Ground Roll Distance — 0° Flaps)

Piper PA-46-350P  
Japan Civil Aviation Bureau Approved  
March 28, 2000

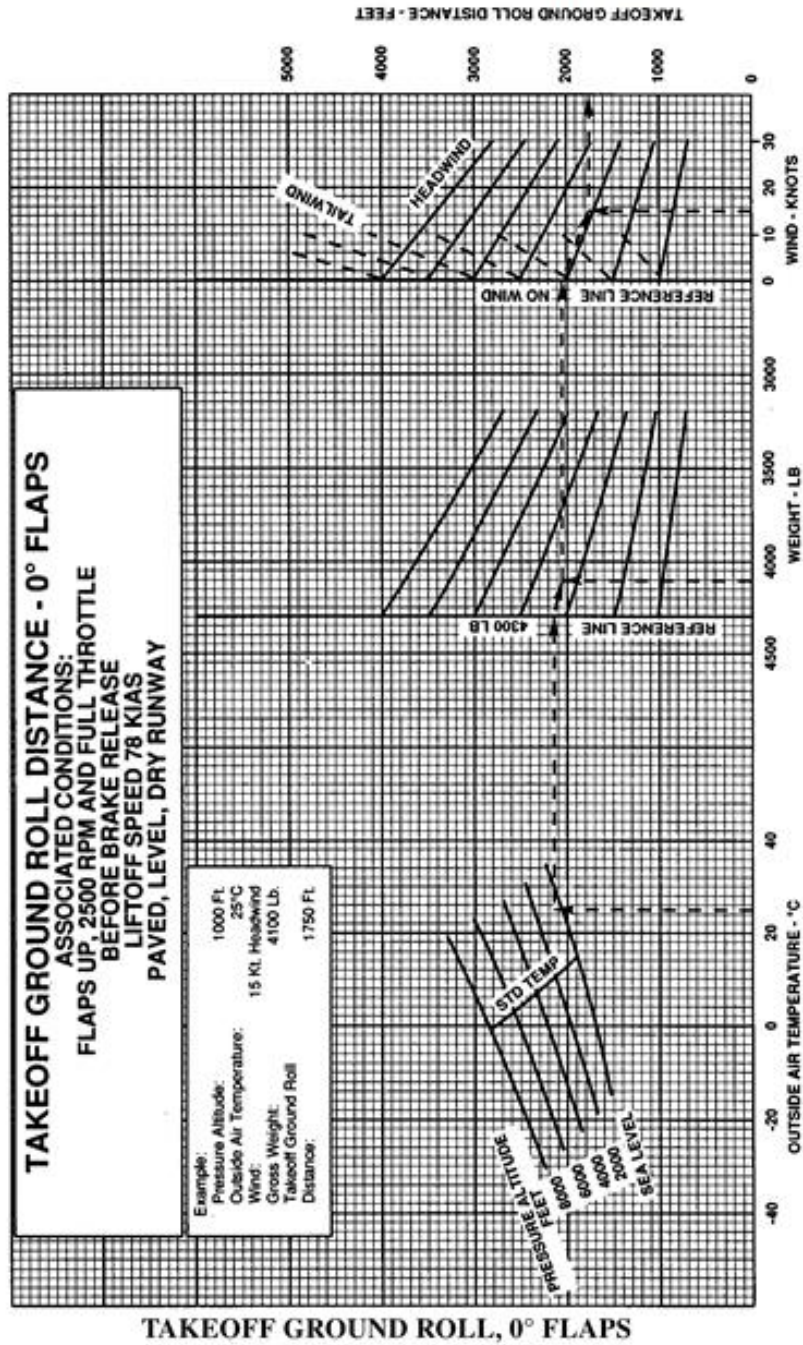
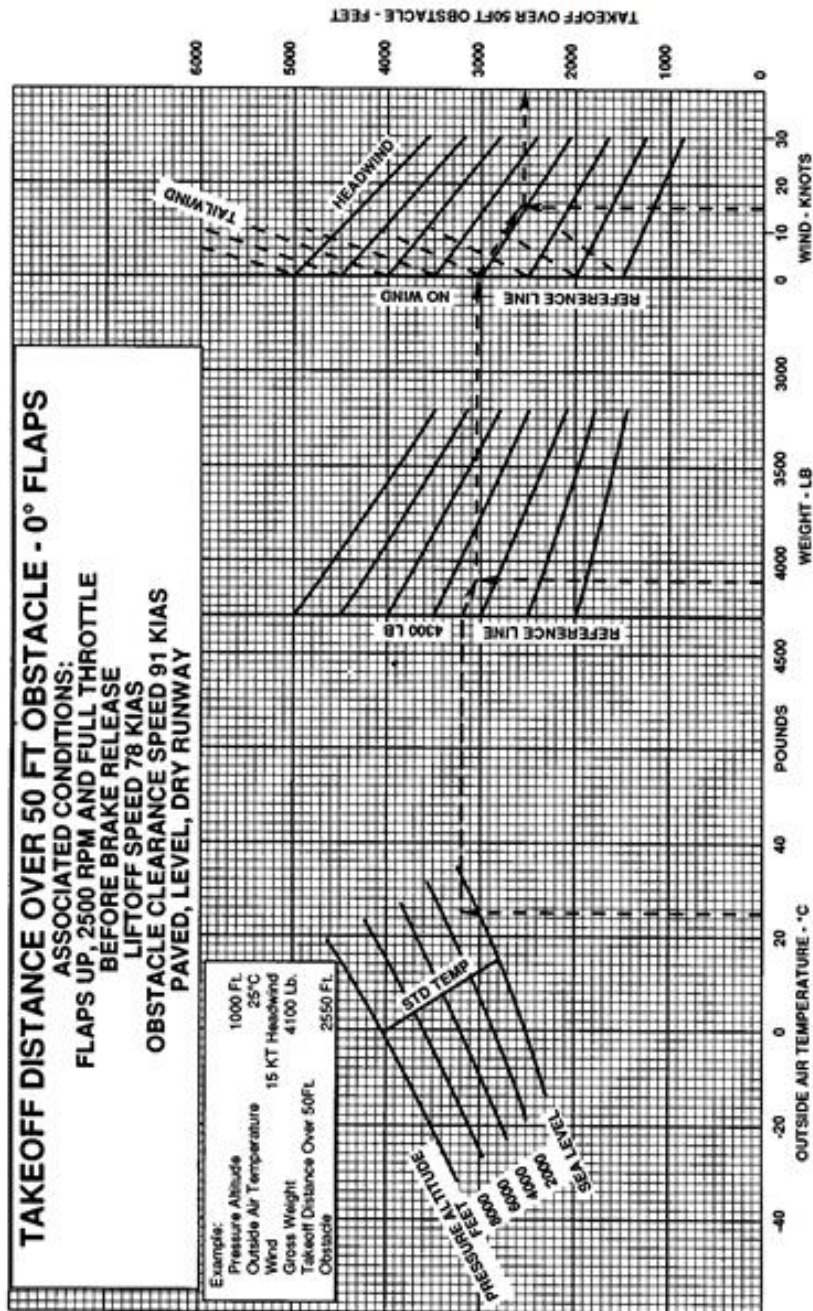

Figure 5-13

# Attachment 3-2 Performance Chart (Takeoff Distance — 0° Flaps)

Piper PA-46-350P  
 Japan Civil Aviation Bureau Approved  
 March 28, 2000



TAKEOFF DISTANCE OVER 50 FT. OBSTACLE, 0° FLAPS

Figure 5-17

# Attachment 3-3 Performance Chart (Short Field Takeoff — Takeoff Ground Roll Distance)

Piper PA-46-350P  
Japan Civil Aviation Bureau Approved  
March 28, 2000

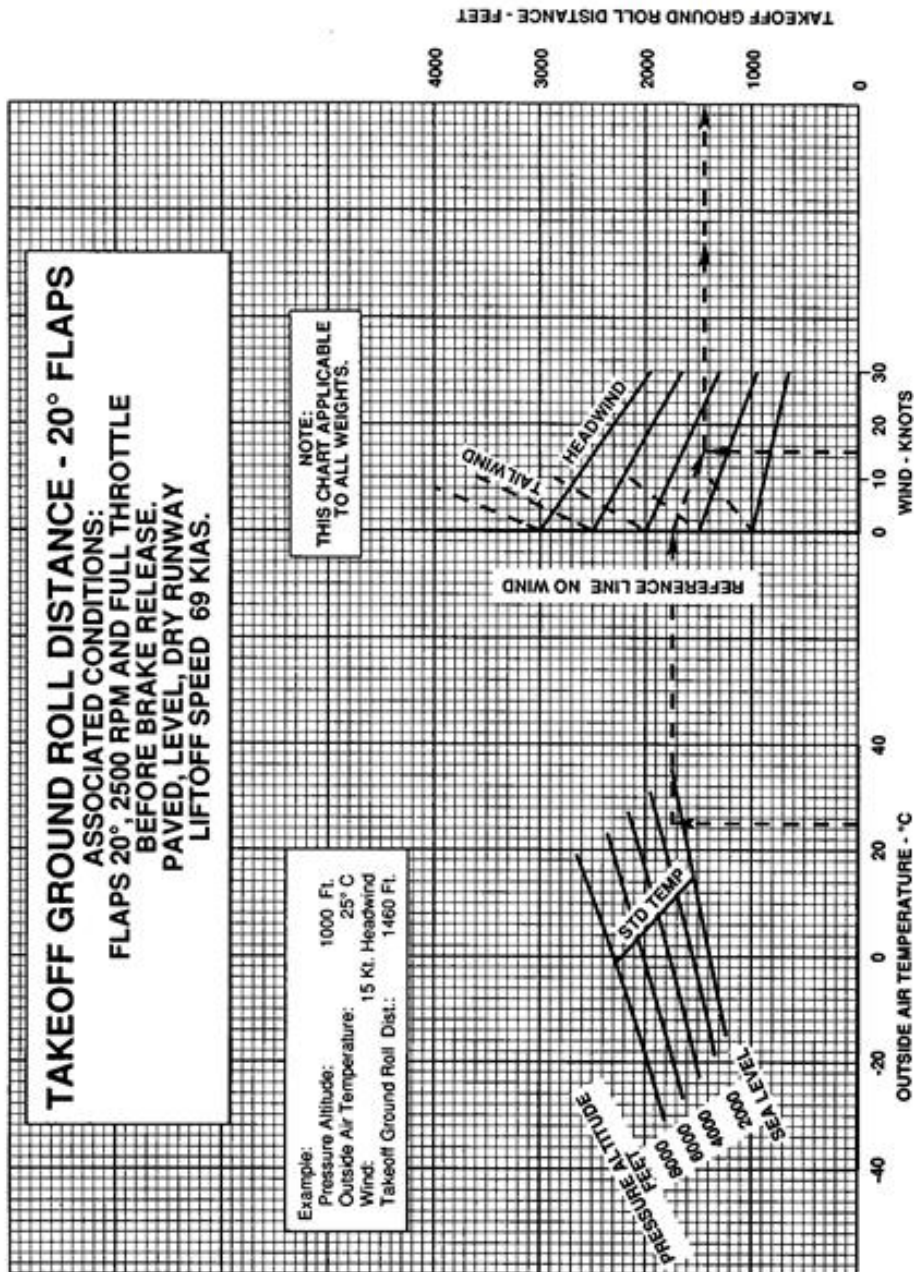

TAKEOFF GROUND ROLL, 20° FLAPS

Figure 5-15



# Attachment 3-4 Performance Chart (Short Field Takeoff — Takeoff Distance)

Piper PA-46-350P  
 Japan Civil Aviation Bureau Approved  
 March 28, 2000

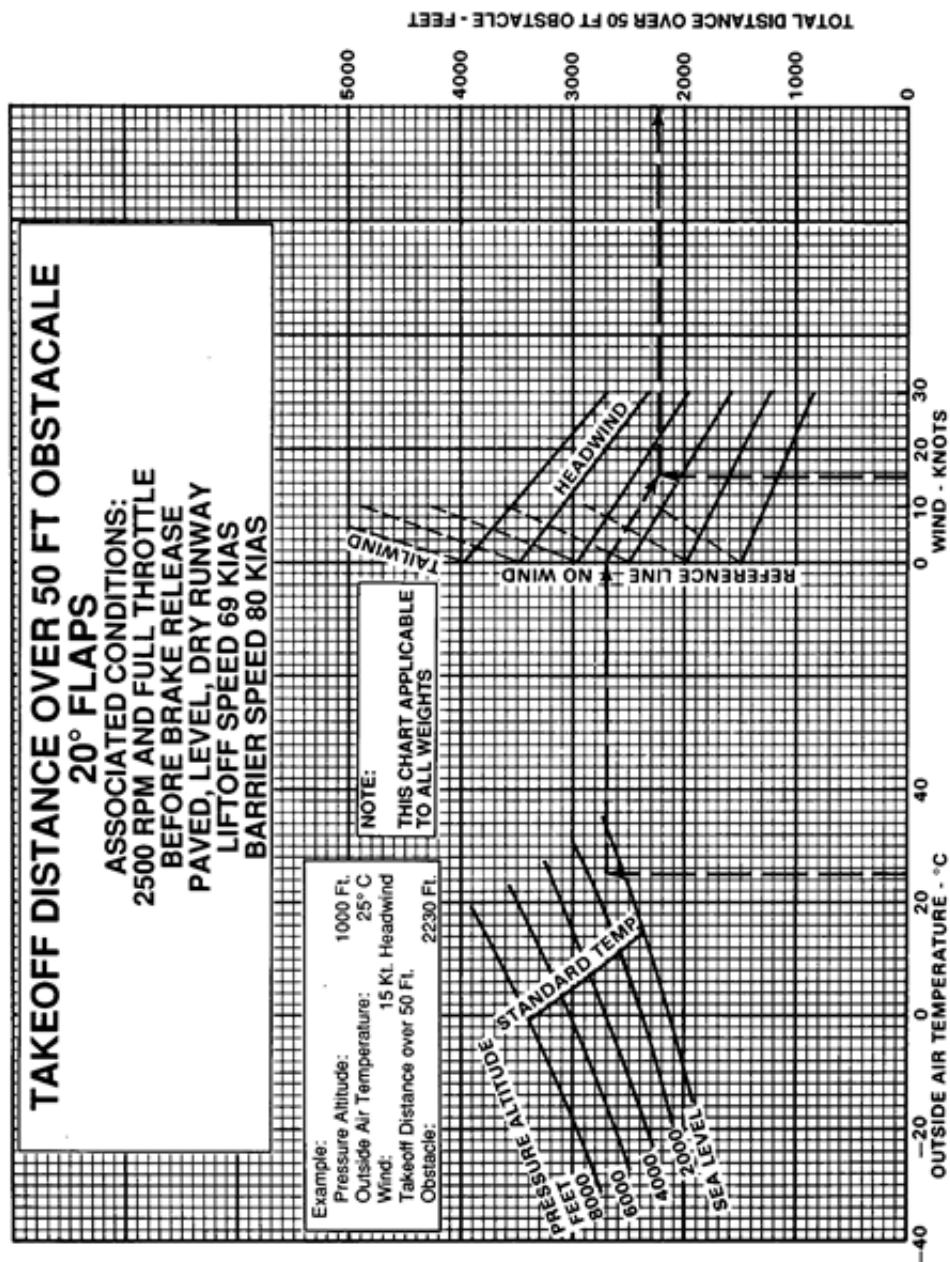

TAKEOFF DISTANCE OVER 50 FT. OBSTACLE, 20° FLAPS  
 Figure 5-19

## Attachment 4      Wind data Around the Time of the Accident

Time of observation	Instantaneous wind direction (true bearing)	Instantaneous wind speed (kt)
10:57:12	243	1
10:57:15	236	1
10:57:18	211	1
10:57:21	200	0
10:57:24	175	0
10:57:27	184	0
10:57:30	184	0
10:57:33	164	0
10:57:36	152	0
10:57:39	172	1
10:57:42	184	1
10:57:45	178	1
10:57:48	199	1
10:57:51	216	1
10:57:54	218	1
10:57:57	204	1
10:58:00	181	1
10:58:03	191	1
10:58:06	179	1
10:58:09	139	1

# Attachment 5

# Flight Test Record (Extract)

Date	Take-off Weight	On Board Fuel	OAT 6000ft	RPM	MAP	Fuel Flow	TIT(T/O)	TIT(6,000ft)	Oil Temp	Oil Pressure	Cylinder Head Temp	Stall Warning FLAP0 Gear Down	Stall Vs FLAP0 Gear Down	Stall Warning FLAP36 Gear Down	Stall Vs FLAP36 Gear Down
	lb	GAL	°C	RPM	in-Hg	GPH	° F	° F	° F	psi	° F	kt	kt	kt	kt
1989/5/15	3718	120	6	2500	42	38.5	1380	1420	180	60	370	79	71	68	61
1994/1/10	3782	80	-5	2480	41.5	37	1340	1380	160	80	320	75	69	70	60
1995/2/13	3782	80	3	2480	42	37	1340	1380	160	80	320	75	70	65	60
1996/2/28	3875.2	90	-8	2480	42	36.5	1380	1480	160	80	340	81	74	65	58
1997/3/25	3882.8	100	2	2500	41.8	38	1480	1520	160	80	340	80	75	67	60
1998/4/16	3871	100	8	2500	41.8	38	1425	1500	160	80	340	80	75	65	59
2000/3/18	4067.2	100	-14	2490	41.8	38	1400	1440	120	80	300	80	74	66	60
2001/4/20	3908.8	100	4	2500	42	38	1400	1450	160	80	340	83	77	74	65
2002/3/1	3998.8	95	-2	2500	42	38	1400	1500	160	180	340	80	74	71	62
2003/3/19	3831.2	90	-7	2500	41.5	38	1520	1520	160	80	340	78	72	70	63
2004/6/29	3831.2	90	18	2500	41.8	40	1400	1420	200	80	360	78	72	68	58
2005/6/23	3831.2	90	16	2480	41.8	40	1380	1420	180	85	320	83	75	72	62
2006/7/26	3831.2	90	20	2500	41.5	40	1360	1380	200	80	360	81	75	70	60
2007/7/20	3966.6	110	16	2500	42	40	1400	1420	180	85	340	80	74	68	60
2011/1/31	3683.2	36	-6	2500	41.5	38	1200	1220	200	80	360	85	76	74	65
2012/3/12	3566.66	46	-8	2500	41.5	39	1180	1240	150	90	320	85	80	72	64
2013/4/23	4008.1	120	0	2500	41.5	39	1080	1080	140	90	320	85	75	74	64
2014/4/28	4032.7	120	6	2475	41.5	38	1100	1200	150	90	300	84	75	73	63
2015/4/19	4015.1	120	10	2480	41.5	40	1080	1100	150	80	300	79	74	73	63

# Attachment 6     Teardown Inspections of Engine, Propeller and Others

## 1 Teardown Inspection of Engine and Propeller

In order to investigate conditions of the engine and propeller of the Aircraft at the time of crash, teardown inspections were conducted at the engine manufacturer's facility (in the U.S.) from January 12 to 13, 2016. The inspections of the engine and engine accessories was performed by the engine manufacturer and that of the propeller, propeller governor and turbochargers was performed by the propeller manufacturer.

1.1 The main contents described in the engine manufacturer's report obtained from the U.S. investigative agency are as follows:

(Excerpt)

### (1) *Engine as Received or First Viewed*

*The engine had thermal signatures consistent with a post crash fire. The engine did not have intercoolers and the propeller was attached. The engine mount and nose gear structure were also still attached to the engine.*

### (2) *Engine Data*

*Last Annual Inspection by: unknown*

*Date: 4/27/15*

*Last Overhaul by: Lycoming Engines*

*Date: 3/22/03*

*Compression Test: N/A*

*Comments: could not rotate engine due to thermal damage and rust in cylinder.*

*Valve Action : Rotate Engine if possible to verify continuity through engine.*

*Comments: could not rotate engine due to thermal damage and rust in cylinder.*

### ① Basic Information

*The engine history shows the engine left the Lycoming Factory on March 22, 2003 and was shipped to Van Bortel Aircraft, Inc. The engine was returned to Lycoming March 24, 2005 for a prop strike inspection at 73.5 hours. The engine was disassembled on March 29, 2005 for the inspection and was reassembled, tested and returned to the customer.*

② Propeller and Propeller Governor

*As first viewed by this ASI, the propeller remained attached to the engine via the crankshaft flange. The propeller was removed from the engine and all disassembly of the propeller was completed by the Hartzell propeller ASI. The propeller governor was found secure to its mount on the crankcase and was removed. The propeller governor gasket screen was clear of contamination or debris. The propeller governor was disassembled by the Hartzell propeller ASI.*

③ Fuel System

*As first viewed by this ASI, the fuel system was thermally breached consistent with a post crash fire. All fuel lines showed evidence of thermal damage. The fuel servo remained secure to the oil sump and air inlet housing assembly. The throttle cable was cut prior to arrival at Lycoming.*

*The fuel flow divider, hard fuel lines, and fuel injector nozzles were found secure and were removed. The fuel flow divider hard lines were flow checked for obstructions using low pressure air with no obstructions noted. The single piece fuel nozzles were removed from the individual cylinders and visually checked for obstructions. Debris consistent with combustion materials and rust were found in the nozzles consistent with debris created during the post crash fire and subsequent firefighting efforts. The flow divider was removed from the case and disassembled. The diaphragm had signs of thermal stress but was not breached. The mechanic breached the diaphragm in an attempt to remove the diaphragm from the flow divider body. No fuel was found in the fuel flow divider. The engine driven geared fuel pump was found secure to its mount and was removed. Signs of thermal damage consistent with a post crash fire were observed on the outer case of the fuel pump and the inlet and outlet fuel lines were thermally breached. The engine driven geared fuel pump was rotated by hand. Suction and compression could not be confirmed due to the pump hanging up during rotation consistent with thermal damage from the post crash fire.*

④ Magneto

*The magnetos were found secure on their respective mounts with heavy thermal damage noted to the rear of each magneto. As such, the magnetos were removed but confirmation of spark could not be made due the thermal damage received on the magnetos.*

⑤ Spark Plugs

*As first viewed by this ASI, all the spark plugs remained secure in their respective cylinder locations. All the spark plugs were removed and photographed in their as-removed condition. The spark plugs were then cleaned and visually inspected for center electrode wear and cracks in the center tower. No visual signs of defect were noted.*

⑥ Ignition Harness

*The ignition harness was thermally destroyed consistent with damage received during the post crash fire.*

⑦ Starter

*As first viewed the starter was found secure on its mount with Bendix gear engaged on the starter ring gear. The starter was removed but was not tested.*

⑧ Generator

*As first viewed, both the left and right alternators were found secure on their associated mounting surfaces and brackets. The left alternator destroyed by fire.*

⑨ Vacuum Pump

*Both vacuum pumps were destroyed due to thermal damage, no data tag information was available.*

⑩ Lubricating System

*The oil suction screen was removed from the oil sump and visually inspected for debris or metal with none found. The oil sump was removed and small amount of oil was noted in the sump. It was a gray/black in color and was free of debris or metal. The remote mount spin on oil filter was shipped with the engine. It showed thermal damage consistent with a post crash fire and was not opened up.*

⑪ Supercharging System

*As first viewed, the turbochargers remained secure to their mounts on the engine. The left turbocharger was thermally destroyed with the compressor housing and compressor impellers thermally destroyed with only the shaft remaining. The right turbocharger was able to rotate freely and had no damage to the compressor impellers. The variable absolute controller was thermally damaged at the outer*

*housing consistent with damage received during a post crash fire. There was no Manifold Pressure Relief Valve found; however, most of the air inlet housing that holds the Manifold Pressure Relief Valve was thermally destroyed consistent with damage received during a post crash fire.*

⑫ Push Rods, Accessory Housing and Oil Pump

*Push Rod Tubes: #2 intake impact damage, all others normal*

*Push Rods: #2 intake impact damage, all others normal*

*Accessory Housing: Thermal signatures consistent with a post crash fire*

*Oil Pump: No contamination found inside the oil pump*

*Gear, Splines and Drivers: rust and thermal signatures were found on most of the accessory housing gears, splines and shafts.*

*As first viewed by this ASI, the push rod tubes and push rods were attached to the engine with thermal signatures consistent with a post impact fire. The #2 intake push rod tube was impact damaged as well as the #2 intake push rod. With the cylinders removed, each push rod was visually inspected and found to be unremarkable. The rockers had normal wear patterns. The accessory housing was removed and the oil pump disassembled. The gears in the accessory housing were rust covered but the gears turned freely. The oil pump gears showed no evidence of metallic particles or scoring on the oil pump housing.*

⑬ Cylinders

*As first viewed by this ASI, the cylinders remained secure on their respective mounts on the crankcase. Thermal signatures consistent with a post crash fire were evident on all six cylinders. Molten metal was found lodge in the cylinder cooling fins on cylinder #1 and #3. All the cylinders were removed and piston removed from the connecting rods. All cylinders exhibited rust inside on the cylinder walls with cylinder #6 exhibiting the heaviest rust. The pistons exhibited no signs of detonation and had normal combustion signatures on the piston head. The intake and exhaust valves were not removed from the cylinders. Visual inspection of the valves heads were unremarkable.*

⑭ Crankcase

*The crankcase was disassembled to remove the crankshaft and camshaft. All bearing journals were normal and unremarkable. The propeller governor gear set*

*screw was visually verified to be in place. The silk thread was visually verified to be in place.*

⑮ Crankshaft

*As first viewed by this ASI, the crankshaft remained inside the crankcase and would not rotate. As the cylinders were removed, the rust present on the crankshaft bearings appeared to contribute to the resistance in rotation of the crankshaft. With all the pistons removed, the crankshaft was rotated at the propeller flange and was able to complete 360 degrees of rotation. All counterweights had the rollers installed with the internal retaining ring in place. The counterweights and the rollers exhibited heavy surface rust. The rear crankshaft gear bolt was installed with the locking tab in place. The crankshaft flange run out was not checked.*

⑯ Camshaft, Connecting Rods and Bearings

*As first viewed by this ASI, the camshaft, connecting rods, and bearings remained in place inside the crankcase. The crankcase was split to remove the camshaft and the connecting rods were removed from the crankshaft. The camshaft lobes were normal and did not show signs of pitting. The camshaft gear was normal with rust present on the face of the gear. The bearings on the #6 connecting rod showed heavy rust that did not allow the connecting rod to move freely and was consistent with rust build up after a post crash fire. All tappet faces were normal and showed no signs of pitting.*

(3) Engine Disassembly Observations

*On January 12th, 2016, the engine was moved to the NTSB/FAA teardown room within the Lycoming Factory for disassembly. The engine was uncrated and placed on a ring stand for initial observation and photo documentation. The engine was completely disassembled and condition documented. The propeller, propeller governor, and turbochargers were disassembled by an ASI from Hartzell Propeller.*

*The engine showed signs of a post crash fire that burnt over the entire engine and propeller. There were no intercooler present and the engine mount and nose gear structure remained attached at the engine mounts.*

*There was nothing found during the course of this engine tear down that would have precluded this engine from making power prior to impact. All damage noted in the sections above is consistent with the engine being involved in the post crash fire of the aircraft at the accident site.*



## 1.2 Teardown Inspections of Propeller/Turbocharger

The main contents described in the propeller manufacturer's report obtained from the U.S. investigative agency are as follows:

### *(1) SUMMARY AND ANALYSIS OF FINDINGS*

*The propeller and propeller governor were examined at Lycoming Engines in Williamsport, PA on January 12, 2016.*

*The propeller remained attached to the engine during the impact sequence and subsequent recover and shipping. The propeller assembly, including spinner was removed from the engine by Lycoming personnel before the teardown examination was conducted. Impact marks on both blade preload plates indicated the propeller was on or near the low pitch setting during the impact sequence. One blade exhibited chord wise abrasion in the tip area on the camber side, indicating rotation before impact. The other blade was mostly consumed by the post-crash fire.*

*A governor teardown examination did not reveal any anomalous conditions.*

### *(2) CONCLUSIONS*

*The propeller showed signs of rotation with power ON and blade angles on or near the low pitch stop during the impact sequence.*

*The pre-load plate markings indicated the propeller was operating on or near the low pitch stop at impact. Blade damage (camber side scoring, aft bending and twisting leading edge down), plus pitch change knob damage all indicate the blades impacted while rotating and at a negative angle of attack, resulting in high twisting moments towards low pitch. Although pre-load plate impact marks appeared to be below the low pitch stop setting of 17.6°, they were likely caused by the impact forces and moments forcibly twisting the blades beyond/lower than the low pitch stop setting. At low aircraft speeds (<70 KIAS), negative blade angles of attack are experienced at power levels below approximately 50% power.*

*There were no discrepancies noted that would prevent propeller operation prior to impact. The propeller was over-serviced with grease which may have caused slow response to power changes, or RPM oscillations, but would not have prevented operation. All damage was consistent with high impact forces twisting the blades towards low pitch, and heat damage due to the post-crash fire.*

*There were no discrepancies noted with the propeller governor that would prevent normal operation prior to impact. The control arm/shaft assembly was missing and appeared to have been forcibly removed either during the impact sequence or during recovery/transporting. The governor otherwise appeared undamaged and could be*

rotated by hand.

(3) *Propeller Teardown Report*

① *General Comments*

*This type propeller is a 2-blade single-acting, hydraulically operated, constant speed model. Oil pressure from the propeller governor is used to move the blades to the high pitch (blade angle) direction. A spring and blade twisting moment move the blades toward the low pitch direction in the absence of governor oil pressure. The blades and hub are of aluminum construction. Propeller rotation is clockwise as viewed from the rear.*

② *Installation Data*

*Reference Hartzell Installation Data Sheet #874*

*(Data reference the 30-inch station)*

*Low Pitch: 17.6 + 0.2 degrees*

*High Pitch: 40.5 + 0.5 degrees*

*Note: Manufacturing records indicated this propeller model was originally assembled with a low pitch angle of 16.0 degrees. However, the last overhaul records in 2005 confirm the low pitch was set to 17.6° before it was reinstalled on the accident aircraft.*

③ *Service History:*

*According to JTSB investigators the propeller was replaced in 2005 after a propeller object/ground strike and at the time of the accident had 1541.01 hours since new.*

	<i>S/N</i>	<i>Date of manufacture</i>	<i>TTSN</i>	<i>TSO</i>
<i>Hub</i>	<i>HA6</i>	<i>6/6/1988</i>	<i>1541.01</i>	<i>926.54</i>
<i>Blades</i>	<i>H00909</i>	<i>6/13/1988</i>	<i>1541.01</i>	<i>926.54</i>
	<i>F96066</i>	<i>6/13/1988</i>	<i>1541.01</i>	<i>926.54</i>

④ *Propeller Serial Number HA6*

⑤ *Factory Serial Number: A12067*

⑥ *Blade Model: F8074K*

*Blade #1: S/N H00909*

*Blade #1: S/N F96066*

⑦ *Blade Orientation:*

*The blades were arbitrarily number 1-2 clockwise as viewed from the rear of the propeller. The hub serial number was between the 1 and 2 blades.*

⑧ *As Received Condition:*

*The propeller was attached to the engine when shipped to Lycoming. The propeller had been removed from the engine by Lycoming personnel prior to my arrival. Photos #1 and #2 show the condition of the propeller prior to the examination. The majority of one blade had been consumed by the post-crash fire. The other blade showed bending in the aft direction and twisting leading edge down (toward low pitch). The spinner dome and bulkhead remained attached to the propeller but approximately 30% was consumed by the post-crash fire.*



Photo#1: Propeller (before teardown)



Photo#2: Spinner part

⑨ *Spinner Dome*

*The spinner dome was still mounted to the spinner bulkhead but crushed on one side and approximately 30% of it was consumed by the post-crash fire. The forward bulkhead was present but had debonded and the flange was bent in several*

*places.*

*⑩ Spinner Bulkhead:*

*The spinner bulkhead remained attached to the hub. Approximately 40% of the bulkhead was either consumed or heat damaged by the post-crash fire.*

*⑪ Propeller Cycling*

*Propeller cycling was not attempted before disassembly due to lack of mounting provisions in the facility, lack of blade paddles to rotate the blades, and/or a method to pressurize the piston.*

*Neither blade could be rotated by hand force only.*

*⑫ Engine/Propeller Mounting*

*The propeller remained attached to the engine throughout the crash sequence and subsequent recovery and shipping to Lycoming. The propeller was removed from the engine at Lycoming.*

*The mounting flange and all six mounting studs appeared intact and undamaged. There was no visually remarkable bending of the mounting studs or damage to the counter bores. The O-ring appeared undamaged and there was oil present in the hub bore leading up to the pitch change rod.*

*⑬ Cylinder (P/N: B-2428-1 Rev. AO, S/N: GK6881)*

*The cylinder was intact but showed signs of heat distress on the exterior surface (charring, bubbling, etc.). The low pitch stop screw had been forced forward, stripping mounting threads in the cylinder but remained in the cylinder and required further unthreading to remove (see Photo # 3).*



Photo#3: Low Pitch Stop

⑭ *Piston:*

*The piston was intact and unremarkable. The piston O-ring was intact but showed signs of heat distress (hard/not pliable, flat and discolored in some areas.)*

*There was oil and what appeared to be sludge aft of the piston which was later determined to be blade bearing grease. Grease and grease byproducts from over-servicing*

*the blade bearings had migrated forward through the hub bushing to the area behind the piston (see Photo #4).*

*Photo #5 shows the excessive amount of grease in the hub.*



Photo#4: Piston part



Photo#5: Hub part

⑮ *Pitch Change Rod*

*The pitch change rod was intact and unremarkable.*

⑯ *Fork*

*The fork was intact. The only visible damage was the plastic bumpers had melted and charred causing some surface discoloration.*

⑰ *Spring*

*The spring was intact. The only remarkable trait was some oil coking/charring*

*discoloration from heat exposure during the post-crash fire.*

*⑱ Pitch Stops*

*Low Pitch Stop: The low pitch stop screw had been forced forward, partially out of the cylinder, stripping mounting threads in the cylinder. But it remained in the cylinder and required further unthreading to remove (see Photo #3).*

*High Pitch Stop: The high pitch stop was intact and unremarkable.*

*⑲ Hub Assembly*

*The preload plate shelves showed deformation on the aft/trailing edge quadrants consistent with the preload plate lip deformation. This deformation indicates the impact forces were a combination of aft and opposite direction of propeller rotation (see Photo #6). The hub was also excessively over-serviced with bearing grease (see Photo #5).*



*⑳ Preload Plates: (see Photos #7 and #8)*

*NOTE: For this propeller model, when the blade knob is aligned with the hub parting line, the blade angle at the reference station is  $48^\circ$  (knob  $\phi = 12^\circ + 36 = 48^\circ$ ). On a two-blade Compact series propeller, pitch change knob impressions are sometimes made on the opposite-side preload plate during the impact sequence. This impression mark can be measured to provide some blade angle information.*



*The # 1 preload plate had a knob impression mark at approximately  $34^{\circ}$  corresponding to a blade angle of  $14^{\circ}$  (below the low pitch stop angle).*



*The # 2 preload plate had a knob impression mark at approximately  $35^{\circ}$  corresponding to a blade angle of  $13^{\circ}$  ( $4.6^{\circ}$  below the low pitch stop angle).*

*② Blade Bearings and Blade Pitch Change Knobs:*

*The blade bearings were intact but the plastic ball spacer and grease on both blades had been heat compromised, was stiff and either crumbled or congealed together. The plastic bushings on the pitch change knobs had melted. The pitch change knob for blade #2 was fractured in the direction opposite low pitch with no signs of fatigue in the fracture surface. The pitch change knob for blade #1 was bent in the direction opposite low pitch with a visual crack at its base (Photo #9). There were small ball indentations in the bearing races on the camber (forward) side of each blade indicating impact forces in the aft direction.*

Photo #9



② *Propeller Blades: (see Photos #10 through #12)*

*There were impressions on each blade butt from pre-load plate contact indicating forces in a helical path (i.e. propeller rotation + forward speed) (Photo #10).*

*Blade #1*

*paint, camber side - Chordwise scoring, heat damage (scorched/charred/corroded).*

*paint, flat side - Heat damaged (scorched/charred/corroded).*

*bend - Bent aft starting approximately 15° from tip, charred/corroded*

*twist - Leading edge down/toward low pitch.*

*lead edge damage - Gouging, nicks, dents and deformation from tip extending approximately 8" toward shank. De-ice boot missing, assumed consumed by fire.*

*trail edge damage - Outboard 6° melted/consumed*

*knob condition - Visually bent opposite low pitch, cracked at base, pre-load plate impact mark at shoulder.*

*Blade #2 (See Appendix A for material composition analysis of melted material shown in Photo #12)*

*paint, camber side - Outboard ~24" of blade melted/consumed, shank was scorched/charred/corroded*

*- Outboard 24" of blade melted/consumed, shank was scorched/charred/corroded*

*bend - Not distinguishable.*



*twist* - Not distinguishable.  
*lead edge damage* - Heat damaged, de-ice boot missing, assumed  
consumed by fire.  
*trail edge damage* - Heat damaged.  
*knob condition* - Fractured, no visual signs of fatigue, only overload.

Photo #10



Photo #11 - Camber Side



Photo #12 - Face Side



(4) *Propeller Governor Teardown Report*

① *Propeller Governor Model: V-11-1*

② *Governor Serial Number: G1455J*

③ *General Comments:*

*The propeller governor is an engine/propeller RPM sensing device and high pressure oil pump. In a constant speed propeller system, the governor responds to a change in engine/propeller RPM by directing oil under pressure to the propeller hydraulic cylinder (when over speeding), or by releasing oil from the hydraulic cylinder to the drain (when under speeding). The change in oil volume in the hydraulic cylinder changes the propeller blade angle and returns the engine/propeller RPM to the pilot selected value. The V-11 series governor is a pressure-to-increase pitch, non-feathering, intermediate capacity governor. The V-11-1 governor is specifically configured for use on the Piper PA-46-350P with the TIO-540-AE2A engine.*

④ *Installation Specifications:*

*Refer to Hartzell Manual 130B for V-11-1 specifications*

⑤ *Service History:*

*No service history data for the governor was presented prior to the examination*

⑥ *As Received Condition:*

*The propeller governor was still mounted to the engine but the control arm/shaft assembly was fractured and missing (see Photo #13). The high RPM stop/adjust screw was intact. The governor was removed from the engine without difficulty and the drive shaft turned freely by hand. The gasket screen did not have any remarkable debris.*

⑦ *Governor Head and Spool Valve:*

*The governor head was removed without difficulty. It appeared the control arm/shaft assembly was forcibly pulled from the head but the rack and rack adjust screw remained in the head. The spool valve appeared undamaged and could be moved by hand within the governor body. Internal oil discoloration implied evidence of high temperatures inside the governor head.*

⑧ *Flyweight Unit:*

*The flyweights were intact and moved freely on their pivot points. The flyweight disk turned freely with shaft rotation by hand.*

⑨ *Oil Pump and Governor Body:*

*The oil pump gears were undamaged and turned freely by hand. The oil pump cavity was free of any foreign objects or debris. The pressure relief valve was intact.*

*See Photo #14 for the governor components disassembled and examined.*



*(5) Metallurgical Laboratory Report*



Photo – Melted Propeller Blade

- ① Test Method: The blade was sectioned and chemical analysis was conducted.*
- ② Test Summary: The melted blade was sectioned and appeared porous throughout. Chemical evaluation indicates that the material is an aluminum alloy containing copper, magnesium, and silicon, but due to the burned nature of the blade, some the constituents could have burned off or changed in amount.*
- ③ Test results:*

*Chemical analysis of the melted propeller indicate the blade was produced from an aluminum alloy containing copper, magnesium, and silicon.*

Table Chemical Analysis Result

<i>Element</i>	<i>Melted blade</i>	<i>2025 AA Limi</i>
<i>Copper</i>	<i>3.3</i>	<i>3.9 to 5.0</i>
<i>Magnesium</i>	<i>1.11</i>	<i>0.050 max.</i>
<i>Silicon</i>	<i>1.13</i>	<i>0.50 to 1.20</i>
<i>Iron</i>	<i>0.28</i>	<i>1.00 max.</i>
<i>Manganese</i>	<i>0.47</i>	<i>0.40 to 1.20</i>
<i>Nickel</i>	<i>0.01</i>	<i>---</i>
<i>Zinc</i>	<i>0.27</i>	<i>0.25 max.</i>
<i>Titanium</i>	<i>0.04</i>	<i>0.15 max.</i>
<i>Chromium</i>	<i>0.02</i>	<i>0.10 max.</i>
<i>Other, ea.</i>	<i>&lt;0.05</i>	<i>0.05 max.</i>
<i>Other, total</i>	<i>&lt;0.15</i>	<i>0.15 max.</i>
<i>Aluminum</i>	<i>Rem.</i>	<i>Remainder</i>

(6) Turbocharger Teardown Report

① TURBO SYSTEM GENERAL INFORMATION:

The turbocharger system installed on the TIO-540-AE2A engine used on the PA-46-350P aircraft is called a “Variable Absolute Pressure System.” The variable absolute pressure controller senses deck pressure, compares it to a reference absolute pressure, and adjusts the wastegate butterfly via the turbo controller valve (controlling turbocharger speed) to maintain the desired horsepower at varying altitudes. It differs from the non-variable version, however, in that the turbo controller is directly linked to the engine throttle, and through a system of cams and followers, adjusts itself to varying power settings, achieving the optimum deck pressure for a given throttle movement. A pressure relief valve set slightly in excess of maximum deck pressure is provided to prevent damaging overboost in the event of a system malfunction. A sonic venturi (customer supplied) is incorporated to provide a constant source of compressed air to the cabin pressurization system. An intercooler (customer supplied) is added to cool the compressor outflow and increase cylinder charge air density. The system includes the components listed in Table 1.

*Only the two turbochargers and wastegate valve body were recovered from the accident aircraft and presented for examination. The controller and pressure relief valve were either not recovered or consumed by the post-crash fire and therefore not examined.*

*② Wastegate:*

*The wastegate valve was free and had full range of motion. The wastegate actuator body was completely consumed by the post-crash fire; only the valve housing assembly, actuator shaft and return spring remained. See Photo #1.*



Photo #1 – Wastegate valve

*③ Right Turbo (Turbo #1 ) Information*

*There was light impact damage, some evidence of heat/sooting, dirt and oily surface on turbine side. There was no evidence of eroding, fretting, or damage to attachment/mounting surfaces.*

*Center Hub Rotation Assembly (CHRA):*

*Note: Dimensional inspections of the CHRA assembly components were not performed since the turbocharger easily rotated freely by finger force; teardown was deemed unnecessary.*

*The compressor wheel spun with the turbine wheel on the shaft. It had moderate blade damage.*

*The turbine wheel appeared undamaged. BackPlate: Intact*



*Photo #2 - Remains of compressor wheel*

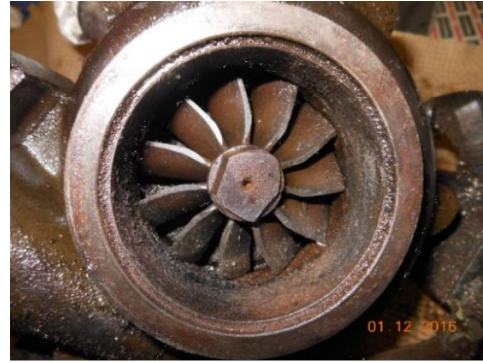

*Photo #3 - Turbine wheel*

#### *④ Left Turbo (Turbo #2) Information*

*The left turbo exhibited extensive fire damage and corrosion. There was no evidence of eroding, fretting, or damage to attachment/ mounting surfaces. The compressor housing, compressor wheel and mounting surfaces were consumed by fire.*

*Clearance Between T-Wheel blades and Housing: Not at all blade locations.*

*Clamps and Lock plates: All turbine lock plates and fasteners intact. The compressor clamps and fasteners were missing or consumed by the post- crash fire.*

*Condition of Compressor Housing: Consumed by post-crash fire.*

*Center Hub Rotation Assembly (CHRA):*

*NOTE: Dimensional inspections of the CHRA assembly components were not performed either due to extreme heat damage or since teardown was conducted at Lycoming; the proper tooling and fixtures were not available.*

*Center Bearing Housing:*

- Existence of Residual Oil. Dry and extreme corrosion present.*



Photo #4 – As-Received Condition 1



Photo #5 Remains of compressor wheel



Photo #6 - Turbine

⑤ *Conclusions and Additional Comments:*

*The Right turbocharger assembly was consistent with the design data and there was no evidence of mechanical malfunction. The turbocharger appeared functional and the wheels spun freely with light finger force. There was evidence of lubrication present (wet surfaces and free rotation).*

*The Left turbocharger assembly components that were not consumed by the post-crash fire appeared consistent with the design data and there was no evidence of mechanical malfunction prior to impact or the post-crash fire. No liquid indication of lubrication was present, presumably due to post-crash fire heat and time elapsed from the accident. The compressor wheel and compressor housing were almost completely consumed by the post-crash fire indicating the level of heat exposure.*

*Although both turbochargers did not show any evidence of pre-impact mechanical malfunction, the turbocharging system performance cannot be verified due to the missing turbo controller, wastegate actuator and pressure relief valve. None of the turbocharger components presented showed evidence*

*of wheel/housing rub but based on the lack of external impact damage, does not indicate the turbochargers were not turning at impact. There is no evidence to suggest the turbocharger system was not functional prior to impact.*

## 2 Teardown Inspection of Magneto

In order to investigate the ignition system of the engine, a teardown inspection of the magneto, which is the main equipment of the system, was performed on August 2, 2016. Since this equipment was charred— especially the non-metal part was significantly consumed and damaged—it was not possible to perform visual inspection, functional inspection and other inspections. See Photos #21 and #22.

### 2.1 General Comments

Starting with a teardown of one magneto and visually checking the inside, it was significantly consumed by the post-crash fire and it was not possible to perform a functional test. Then the other magneto was tore down and the condition was similar.

The main conditions confirmed at the time of the teardown are as follows:

- (1) The ignition harness was mostly consumed;
- (2) The distributor block was damaged by fire;
- (3) The distributor rotor was melted;
- (4) The coil assembly was damaged by fire;
- (5) The field through capacitor was consumed;
- (6) Although the breaker point was damaged by fire, there was no major damage at the contact point which could be inspected;
- (7) The primary lead wire connecting the field through capacitor and the coil assembly was not broken.
- (8) The rotating magnet could be rotated freely by hand.



Photo #21: Magneto (Right side)



Photo #22: Magneto (Left side)



### 3 Teardown inspection of Air Conditioning System (Air Conditioner)

According to the flight manual of the Aircraft, it is prohibited to use the air conditioning system (hereinafter referred to as “Air Conditioner”) at the time of takeoff and landing because it cannot obtain normal takeoff climb performance if it is on. The aircraft manufacturer said that the engine power is reduced by approximately 1 % (3-5 HP) when the Air Conditioner is operating. In addition, the use of the Air Conditioner when an aircraft leaves a parking area will not cause any safety problem if it is turned off before takeoff. The compressor of the Air Conditioner recovered from the accident site was tore down and the state of the Air Conditioner before the accident was investigated.

To investigate the operating condition of the Air Conditioner at the time of takeoff, a teardown inspection was performed by the Air Conditioner manufacturer on May 9, 2016. The main details of the report prepared by the manufacturer are as follows:

#### 3.1 Teardown of Each Part of the Compressor

##### (1) Electromagnetic Clutch

Attraction (electric power ON) and separation (electric power OFF) operations of the clutch plate were available and there was no problem.

##### (2) Around the Shaft Rotor

###### A. Front thrust bearing

No wear or deformation was found and there was no problem.

###### B. Bearing rolling part of main bearing/shaft roller

No wear or deformation was found and there was no problem.

###### C. A set of rear thrust bearing

No wear or deformation was found and there was no problem.

##### (3) Around the Planet Plate

###### A. A set of ball bearings/a set of gears

No wear or deformation was found and there was no problem.

###### B. Rod sliding part of the planet plate

There was no problem.

##### (4) Piston / Cylinder Bore Part / Rod Sliding Part of the Piston

No wear or deformation was found and there was no problem.

##### (5) Around Valves

###### A. Discharge valve

No gap was found and there was no problem.

###### B. Inlet valve

No gap was found and there was no problem.

### 3.2 Investigation on Whether Air Conditioner was Operating before the Accident

#### (1) Result of analysis of black substance attached inside the crank chamber

A black substance was found attached to the lower inner surface of the crank chamber after the accident. No substance was found on the upper side.

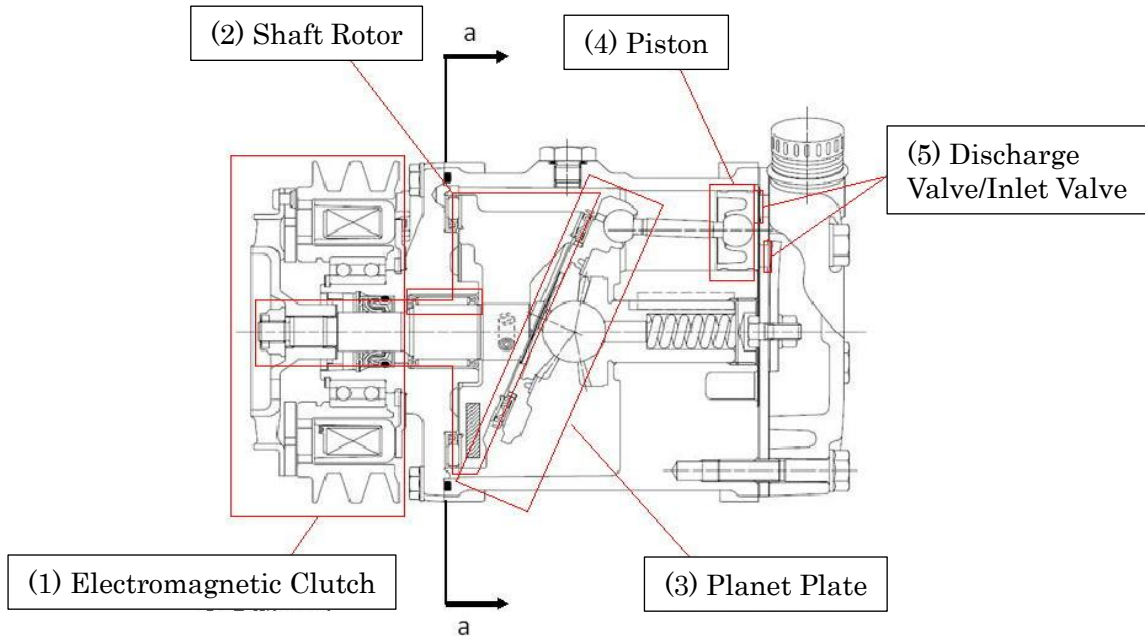
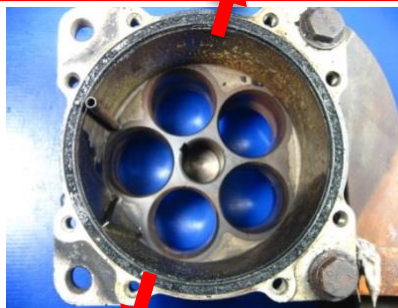

Figure. Attachment 6 3.2 (2) Compressor (cross-section)

Fourier transform infrared light absorption spectrometry was performed to identify the black substance attached and it matched refrigerating machine oil, SP10A. The refrigerating machine oil was found attached only on the lower side of the wall surface in the crank chamber after the accident.

This is the lower side of the part if the Aircraft was not upside-down



This was the lower side after the accident

Photo #23: a-a Cross Section

(2) Observation

The table below shows the condition of refrigerating machine oil attached to the inner wall of the crank chamber in relation to the operating condition of the air conditioning system from departure to takeoff and at the time of takeoff.

Table. Attachment 6 3.2 (2) Observation Related to the Operating Condition of Air Conditioning System

	Operating condition of air conditioning system		Condition of refrigerating machine oil attached to the inner surface of the crank chamber		
	Before takeoff	At the time of takeoff	At the time of takeoff	At the time of the accident	After the fire (heating)
1	Operating	Operating	Attached to the entire inner surface (Oil stirred by movable parts)	Attached to the entire inner surface of the crank chamber due to oil's viscosity	Burned refrigerating machine oil (black substance) attached to the entire inner surface
2	Operating	Not Operating	Attached to the entire inner surface (Attached due to oil's viscosity)		
3	Not Operating	Operating	Attached to the entire inner surface (Oil stirred by movable parts)		
4	Not Operating	Not Operating	Attached to the entire inner surface (Oil and condensed refrigerant were mixed and the viscosity was reduced)	Attached to the entire inner surface (The part turned upside down after the accident, resulting in the attachment of oil and condensed refrigerant to the lower surface due to gravity)	It is somewhat likely that burned refrigerating machine oil (black substance) attached to the lower inner surface after the accident

4 Inspection of High and Low Pitch Stops of Propeller

After the teardown inspection by the propeller manufacturer, angles of high and low pitch stops were inspected from the propeller hub of the Aircraft with the cooperation of relevant administrative organization in Japan from June 10, 2016. Main details of the report are as follows:

Although angles of high and low pitch stops were inspected from the recovered propeller hub of the Aircraft, it is possible that propeller pitch angles measured this time do not completely represent the condition before the accident because the hub was deformed due to the crash and heat.

Under normal conditions, the blade angle of the propeller matches the value measured at the 75 % position of the radius. However, both propeller blades of the Aircraft were damaged and it was difficult to measure them. Then, by measuring the operating range of the Pitch Change Nob (hereinafter referred to as “Nob”) attached to the butt of the propeller blades to change the propeller pitch angle, values of high and low pitch stops were calculated. According to the material from the propeller manufacturer, the following relationship exists between angle of Nob  $\varphi$  and propeller pitch angle  $\beta$ :

$$\beta = 48 - \varphi$$

Based on the technical data and other materials provided by the propeller manufacturer, the butt part of the propeller blade, including Nob, was created by a 3D printer (see Photo #24). In addition, since the adjusting bolt of the low pitch stop was damaged, it was substituted by a bolt with the same length (see Photo #25).

The conditions of assembled parts measured are shown in Photos #26 to #29, and the results of Nob angle measurements are shown in the table below.



Photo #24: Butt part of propeller blade created by 3D printer



Photo #25: Low Pitch Stop Bolt (bottom) and Substitute Bolt (top)



Photo #26: High Pitch Stop Blade #1

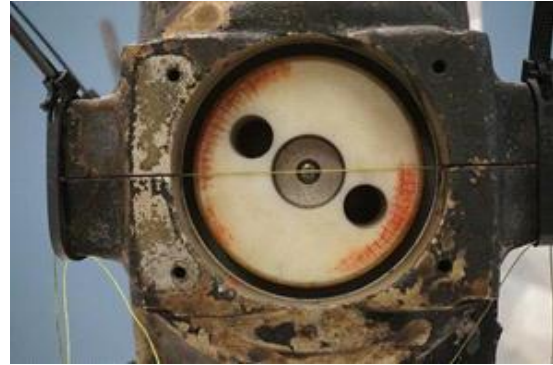

Photo #27 Low Pitch Stop Blade #1



Photo #28: High Pitch Stop Blade #2



Photo #29: Low Pitch Stop Blade #2

Table. Attachment 6 4 Propeller Pitch Angles

	Blade #1 (deg)		Blade #2 (deg)	
	Nob $\varphi$	Pitch $\beta$	Nob $\varphi$	Pitch $\beta$
High Pitch Stop	7.5	40.5	7.7	40.3
Low Pitch Stop	33.0	15.0	32.8	15.2