

AA2012-6

**AIRCRAFT ACCIDENT  
INVESTIGATION REPORT**

**NAKANIHON AIR SERVICE CO., LTD.**

**J A 3 9 0 2**

July 27, 2012



The objective of the investigation conducted by the Japan Transport Safety Board in accordance with the Act for Establishment of the Japan Transport Safety Board and with Annex 13 to the Convention on International Civil Aviation is to determine the causes of an accident and damage incidental to such an accident, thereby preventing future accidents and reducing damage. It is not the purpose of the investigation to apportion blame or liability.

Norihiro Goto  
Chairman,  
Japan Transport Safety Board

Note:

This report is a translation of the Japanese original investigation report. The text in Japanese shall prevail in the interpretation of the report.

# AIRCRAFT ACCIDENT INVESTIGATION REPORT

NAKANIHON AIR SERVICE CO., LTD.  
CESSNA TU206G, JA3902  
IN THE MOUNTAINS EAST OF MT. IWABE-DAKE,  
FUKUSHIMA-TOWN, MATSUMAE-GUN,  
HOKKAIDO PREFECTURE  
AROUND 10:40 JST, JULY 28, 2010

June 22, 2012

Adopted by the Japan Transport Safety Board

Chairman	Norihito Goto
Member	Shinsuke Endoh
Member	Toshiyuki Ishikawa
Member	Sadao Tamura
Member	Yuki Shuto
Member	Toshiaki Shinagawa

# SYNOPSIS

## Summary of the Accident

On July 28 (Wednesday), 2010, a Cessna TU206G, registered JA3902, operated by Nakanihon Air Service Co., Ltd., took off from Niigata Airport at 08:49 local time<sup>1</sup> for a ferry flight to Sapporo Airfield, but it did not arrive there even after the estimated arrival time of 12:49 and went missing. Search and rescue (SAR) activities found the crashed aircraft in the mountains east of Mt. Iwabe-dake in Fukushima-town, Matsumae-gun, Hokkaido Prefecture, on July 30 (Friday), 2010.

The pilot in command (PIC) and one passenger were on board the aircraft and both of them suffered fatal injuries.

The aircraft was destroyed, but no fire broke out.

## Probable Causes

Loss of visual contacts with the ground and following failure to maintain minimum safe altitude over the mountains in Oshima Peninsula during a VFR flight to Sapporo Airfield probably led to the Aircraft's crash into the tree canopies on the ridge, resulting in a total destruction of the Aircraft and fatal injuries of the PIC and the passenger.

It is probable that the PIC's belated decision to turn back resulted in the loss of visual contact with the ground.

---

<sup>1</sup> Japan Standard Time (JST): UTC+9hr, unless otherwise stated all times are indicated in JST on a 24-hour clock.

Abbreviations used in this report are as follows:

ATC	: Air Traffic Control
BECMG	: Becoming
BKN	: Broken
CAVOK	: Cloud and Visibility OK
CRM	: Crew Resource Management
DME	: Distance Measuring Equipment
ELT	: Emergency Locator Transmitter
FEW	: Few
FSC	: Flight Service Center
IFR	: Instrument Flight Rules
IMC	: Instrument Meteorological Conditions
NTSB	: National Transportation Safety Board
RCC	: Rescue Coordination Center
TAF	: Terminal Aerodrome Forecast
TEMPO	: Temporary
VFR	: Visual Flight Rules
VHF	: Very High Frequency
VMC	: Visual Meteorological Conditions
VOR	: VHF Omni-Directional Radio Range

#### Unit Conversion Table

1 kt	: 1.852 km/h (0.5144 m/s)
1 nm	: 1.852 m
1 ft	: 0.3048 m
1 lb	: 0.4536 kg
1 in	: 2.54 cm
1 inHg	: 33.86 hPa

# TABLE OF CONTENTS

1. PROCESS AND PROGRESS OF THE INVESTIGATION.....	- 1 -
1.1 Summary of the Accident.....	- 1 -
1.2 Outline of the Accident Investigation .....	- 1 -
1.2.1 Investigation Organization .....	- 1 -
1.2.2 Representative from Foreign Authorities.....	- 1 -
1.2.3 Implementation of the Investigation.....	- 1 -
1.2.4 Comments from Parties Relevant to the Cause of the Accident.....	- 1 -
1.2.5 Comments from the Relevant State .....	- 1 -
2. FACTUAL INFORMATION.....	- 1 -
2.1 History of the Flight .....	- 1 -
2.2 Injuries to Persons.....	- 3 -
2.3 Information about Damage to the Aircraft .....	- 3 -
2.3.1 Extent of Damage.....	- 3 -
2.3.2 Damage to Aircraft Components.....	- 3 -
2.4 Other Damage.....	- 3 -
2.5 Personnel Information.....	- 3 -
2.6 Aircraft Information .....	- 3 -
2.6.1 Aircraft.....	- 3 -
2.6.2 Engine.....	- 4 -
2.6.3 Weight and Balance.....	- 4 -
2.6.4 Fuel and Lubricating Oil.....	- 4 -
2.6.5 Equipment .....	- 4 -
2.7 Meteorological Information .....	- 4 -
2.7.1 Weather Outlook.....	- 4 -
2.7.2 TAF.....	- 5 -
2.7.3 Aeronautical Weather Observation Data for Airports and Airfields.....	- 6 -
2.7.4 Weather Condition Observed by a Resident about 7 Km North of Accident Site.....	- 8 -
2.7.5 Weather Condition Observed by the Company's Pilot.....	- 8 -
2.7.6 Weather Condition Observed by Pilot of Search and Rescue Organization .....	- 9 -
2.8 Information about Flight Plan and Operation Services.....	- 9 -
2.8.1 Jobs Performed by PIC before Accident .....	- 9 -
2.8.2 Aircraft Operation Control at Niigata Airport.....	- 9 -
2.8.3 Operation Control for the Aircraft at Section for Operation Control at the Company's Head Office.....	- 10 -
2.9 Information about Communication.....	- 11 -
2.10 Information about Radio Systems.....	- 11 -
2.10.1 VHF Radios.....	- 11 -
2.10.2 Emergency Locator Transmitter.....	- 11 -
2.11 Information about the Accident Site and Wreckage .....	- 11 -
2.11.1 Accident Site .....	- 11 -
2.11.2 Details of Damage .....	- 12 -
2.12 Medical Information .....	- 13 -
2.13 Information on Search and Rescue Operation.....	- 13 -

2.14	Information on Aircraft's Operation.....	- 13 -
2.15	Information on Flight Manual.....	- 15 -
2.16	Information on Company's Flight Operation Manual 1.....	- 15 -
2.17	Laws and Ordinances about IMC and VMC.....	- 17 -
2.18	Laws and Ordinances about Minimum Safety Altitude.....	- 18 -
3.	ANALYSIS.....	- 18 -
3.1	Qualification of Personnel.....	- 18 -
3.2	Airworthiness Certificate of the Aircraft.....	- 18 -
3.3	Relations with Meteorological Phenomena.....	- 18 -
3.3.1	Confirmation of Weather Condition before and after Departure by PIC.....	- 18 -
3.3.2	Meteorological Condition during Flight.....	- 19 -
3.4	Development of Flight.....	- 20 -
3.4.1	Flight Route Flown until Crash.....	- 20 -
3.4.2	Crash Sequence.....	- 20 -
3.5	Judgment by PIC until Crash.....	- 21 -
3.5.1	Plan for Flight Route via Western Coast of Hokkaido.....	- 21 -
3.5.2	Advance to Mountainous Area in Oshima Peninsula.....	- 21 -
3.6	Aircraft Condition.....	- 22 -
3.7	Distress Signals Sent by ELT.....	- 22 -
3.8	Selection of Continued VFR Flight under Reduced Visibility Condition for Company Flights.....	- 22 -
3.9	Compliance with VMC and Minimum Safe Altitude.....	- 23 -
3.10	Preventive Measures.....	- 23 -
3.10.1	Pre-flight Confirmation of Meteorological Information by Pilots with Operation Controller Involved.....	- 23 -
3.10.2	Operation Monitoring and Operation Assistance.....	- 23 -
3.10.3	VMC and Minimum Safe Altitude for Company Flights.....	- 24 -
3.10.4	Request for Radar Vector.....	- 24 -
3.10.5	Safety Education for Pilots.....	- 24 -
4.	CONCLUSIONS.....	- 25 -
4.1	Summary of Analysis.....	- 25 -
4.2	Probable Causes.....	- 26 -
5	ACTIONS TAKEN.....	- 26 -
5.1	Actions Taken for Retraining and Others.....	- 26 -
5.2	Matters for Which Actions for Improvement are Taken.....	- 27 -

- Figure 1 Estimated Flight Route
- Figure 2 Accident Site Layout
- Figure 3 Oshima Peninsula Area Layout
- Figure 4 Three Angle View of Cessna TU206G
- Figure 5 Asia Pacific Surface Analysis Chart (0900JST 28 July)

Figure 6	Asia Pacific Surface Analysis Chart (1500JST 28 July)
Figure 7	Meteorological Satellite Japan Area Visible Imagery (1030JST 28 July)
Figure 8	Meteorological Satellite Japan Area Visible Imagery (1500JST 28 July)
Figure 9	Radar Echo Chart (1040JST 28 July)
Figure 10	Radar Echo Chart (1500JST 28 July)
Figure 11	Operating Limitation Decision Table
Photo 1	Accident Aircraft (Before Accident)
Photo 2	Left Main Wing
Photo 3	Propeller
Photo 4	Instrument Panel
Photo 5	Empennage and Right Main Wing
Photo 6	Fuselage
Photo 7	Engine



# 1. PROCESS AND PROGRESS OF THE INVESTIGATION

## 1.1 Summary of the Accident

On July 28 (Wednesday), 2010, a Cessna TU206G, registered JA3902, operated by Nakanihon Air Service Co., Ltd., took off from Niigata Airport at 08:49 local time<sup>2</sup> for a ferry flight to Sapporo Airfield, but it did not arrive there even after the estimated arrival time of 12:49 and went missing. Search and rescue (SAR) activities found the crashed aircraft in the mountains east of Mt. Iwabe-dake in Fukushima-town, Matsumae-gun, Hokkaido Prefecture, on July 30 (Friday), 2010.

The pilot in command (PIC) and one passenger were on board the aircraft and both of them suffered fatal injuries.

The aircraft was destroyed, but no fire broke out.

## 1.2 Outline of the Accident Investigation

### 1.2.1 Investigation Organization

On July 30, 2010, the Japan Transport Safety Board designated an investigator-in-charge and two other investigators to investigate this accident.

### 1.2.2 Representative of the Relevant State

An accredited representative of the United States of America, as the State of Design and Manufacture of the aircraft involved in this accident, participated in the investigation.

### 1.2.3 Implementation of the Investigation

July 31 to August 4, 2010	On-site investigation and interviews
August 10, 12, and 13, 2010	Interviews
August 25 to 29, 2010	Aircraft examination
September 24, 2010	Interviews
October 4, 2010	Interviews
February 23, 2011	Interviews

### 1.2.4 Comments from Parties Relevant to the Cause of the Accident

Comments were invited from parties relevant to the cause of the accident.

But comments from the PIC and the passenger were not obtained because of their decease.

### 1.2.5 Comments from the Relevant State

Comments were invited from the relevant State.

# 2. FACTUAL INFORMATION

## 2.1 History of the Flight

On July 28, 2010, at 08:49, a Cessna TU206G, registered JA3902 (hereinafter referred to as "the Aircraft"), operated by Nakanihon Air Service Co., Ltd. (hereinafter referred to as "the Company"), took off from Niigata Airport for a ferry flight to Sapporo Airfield with the PIC in the

---

<sup>2</sup> Japan Standard Time (JST): UTC+9hr, unless otherwise stated all times are indicated in JST on a 24-hour clock.

left pilot seat and the passenger in the right pilot seat.

The outline of the flight plan for the Aircraft was as follows:

Flight rules:	Visual Flight Rules (VFR)
Departure aerodrome:	Niigata Airport
Estimated off-block time:	08:50
Cruising speed:	120 kt
Cruising altitude:	VFR
Route:	Shonai VOR/DME – Akita VOR/DME – Tsugaru – Matsumae – Motta Peninsula – Shakotan Peninsula
Destination aerodrome:	Sapporo Airfield
Total estimated elapsed time:	4 hrs.
Purpose of flight:	Ferry flight
Fuel load expressed in endurance:	5 hrs. and 30 min.
Persons on board:	2

The history of the flight up to the time of the accident is summarized as below according to the communication records with the flight service organization involved and radar track records for air traffic control as well as the Company's in-house radio communication records.

Around 08:55	The Aircraft reported to the Company's Niitaga office of its take-off and asked for aeronautical weather data for Sapporo Airfield and Okushiri Airport as of 09:00 as soon as they were available.
Around 09:07	Niigata office provided the Aircraft with the requested data.
Around 09:20	The Aircraft reported to Niigata office that it was flying at about 7,500 ft about 5 nm north of Shonai VOR/DME. The Aircraft also reported that it would leave the company radio frequency to switch to Sendai Flight Service Center (FSC), the Civil Aviation Bureau of the Ministry of Land, Infrastructure, Transport and Tourism (MLIT).
09:43:50	The Aircraft reported to Sendai FSC that the Aircraft was flying at about 3,500 ft over Akita VOR/DME.
Around 10:00	The Aircraft flew over Noshiro City, Akita Prefecture, at about 3,500 ft.
10:30:07	The Aircraft reported to New Chitose FSC of the Aircraft's normal operation over Tappizaki at about 3,500 ft.
10:37:32	The Aircraft continued to fly northward over the Tsugaru Straits at an altitude of about 3,500 ft and started a descent just in front of Hokkaido.
10:39:16	After changing its course to north-northeast the Aircraft descended to about 2,300 ft, climbed to about 2,500 ft in a right turn and headed for east-southeast.
10:39:52	The Aircraft disappeared from the ATC radar at an altitude of about 2,500 ft while flying east-southeastward over the mountains which border Shiriuchi-town, Kamiiso-gun and Fukushima-town, Matsumae-gun, Hokkaido Prefecture.
About 12:49	The estimated arrival time at Sapporo Airfield elapsed with no communication received from the Aircraft.

This accident occurred around 10:40, at a place with an elevation of about 750 m (about 2,460 ft) near a ridge in the mountains east of Mt. Iwabe-dake in Fukushima-town, Matsumae-gun, Hokkaido Prefecture (41°32'18" N, 140°21'46" E).

(See Figure 1 Estimated Flight Route, Photo 1 Accident Aircraft (Before Accident) )

## 2.2 Injuries to Persons

The PIC and the passenger suffered fatal injuries.

## 2.3 Information about Damage to the Aircraft

### 2.3.1 Extent of Damage

Destroyed

### 2.3.2 Damage to Aircraft Components

Fuselage	Damaged
Main wings	Both wings damaged, detached from the fuselage.
Empennage	Damaged, detached from the fuselage.
Engine	Damaged, detached from the fuselage.
Propeller	Damaged, detached from the engine.

(See Photo 1 Accident Aircraft (Before Accident) Photo 2 Left Main Wing Photo 3 Propeller Photo 4 Instrument Panel Photo 5 Empennage and Right Main Wing Photo 6 Fuselage Photo 7 Engine)

## 2.4 Other Damage

Dozens of trees in the area of the accident site were torn off or damaged.

## 2.5 Personnel Information

PIC	Male, Age 46	
Commercial pilot certificate (Airplane)		July 25, 1997
Rating for Multiple-engine (land)		January 14, 1992
Rating for Single-engine (land)		March 21, 1992
Instrument flight certificate		April 9, 2008
Class 1 aviation medical certificate		
Validity		March 13, 2011
Total flight time		4,365 hrs. 16 min.
Flight time in the last 30 days		25 hrs. 20 min.
Total flight time on the type of aircraft		483 hrs. 10 min.
Flight time in the last 30 days		13 hrs. 05 min.

## 2.6 Aircraft Information

### 2.6.1 Aircraft

Type	Cessna TU206G
Serial number	U20604657
Date of manufacture	October 11, 1978
Certificate of airworthiness	DAF-2010-058

Validity	May 8, 2011
Category of airworthiness	Airplane, Normal N or Special X
Total flight time	6,264 hrs. 34 min.
Flight time since last periodical check (200h Check on April 22, 2010)	45 hrs. 10 min.

(See Figure 4 Three Angle View of Cessna TU206G )

## 2.6.2 Engine

Type	Continental TSIO-520-M
Serial number	532306
Date of manufacture	February 10, 2006
Total time	785 hr. 39 min.

## 2.6.3 Weight and Balance

When the accident occurred, the Aircraft's weight is estimated to have been 3,327 lb and the center of gravity (CG) is estimated to have been 44.5 in. aft of the reference point, both of which are estimated to have been within the allowable ranges (the maximum takeoff weight of 3,600 lb and the CG range of 40.1 to 49.7 in. corresponding to the weight at the time of the accident).

## 2.6.4 Fuel and Lubricating Oil

The onboard fuel was Aviation Gasoline AVGAS100 and lubricating oil was AEROSHELL W-100.

## 2.6.5 Equipment

The Aircraft was equipped with necessary systems for operations to be described in 2.15, including systems for IFR flights. But with no anti-icing system installed flying under the icing meteorological condition was prohibited. The Aircraft was not equipped with a weather radar unit and an autopilot system.

(See Figure 11 Operation Limitation Decision Table)

## 2.7 Meteorological Information

### 2.7.1 Weather Outlook

A weather outlook issued for the Oshima-Hiyama region of Hokkaido by the Hakodate Marine Observatory at 10:43 on the day of the accident was as follows:

Exercise a continued caution against mudslides in the southern part of the Oshima-Hiyama region until past noon 28th. Continued caution will be necessary against lightning, tornadoes and other violent gusts, hail and traffic disturbances caused by dense fog through 29th.

With a low pressure in the Sea of Okhotsk, Hokkaido is under a trough.

Weather in the Toshima-Hiyama region as of 09:00 on 28<sup>th</sup> is cloudy and in some areas, rainy.

On 28<sup>th</sup>, it will be cloudy, and will rain past noon. Some areas will observe fogs with thunders.

On 29<sup>th</sup>, it will rain and some areas will observe fogs with thunder clouds.

(See Figure 5 Asia Pacific Surface Analysis Chart (0900JST 28 July) Figure 6 Asia Pacific Surface Analysis Chart (1500JST 28 July) Figure 7 Meteorological Satellite

## 2.7.2 Terminal Aerodrome Forecast

(1) Details of the TAF for New-Chitose Airport around the time of the accident were as follows:

Forecast release time: 05:41, July 28 Validity: 06:00, July 28 to 09:00, July 29

Wind direction	180°	Wind velocity	13 kt	Visibility	over 10 km
Clouds	Amount FEW	Type	Unknown	Cloud base	500 ft
	Amount BKN	Type	Unknown	Cloud base	2,500 ft

TEMPO\*<sup>3</sup> Start time and end time of change: 12:00, July 28 to 18:00, July 28

Visibility	3,000 m	Thunderstorm,	Mist		
Clouds	Amount BKN	Type	Unknown	Cloud base	800 ft
	Amount BKN	Type	Cumulonimbus	Cloud base	2,500 ft

BECMG\*<sup>4</sup> Start time and end time of change: 18:00, July 28 to 21:00, July 28

Clouds	Amount FEW	Type	Unknown	Cloud base	200 ft
	Amount BKN	Type	Unknown	Cloud base	500 ft

(2) Details of the TAF for Hakodate Airport, located about 46 km northeast of the accident site, around the time of the accident were as follows:

Forecast release time: 05:49, July 28 Validity: 06:00, July 28 to 09:00, July 29

Wind direction	220°	Wind velocity	13 kt	Visibility	8 km	Showers
Clouds	Amount FEW	Type	Unknown	Cloud base	500 ft	
	Amount BKN	Type	Unknown	Cloud base	1,500 ft	

TEMPO Start time and end time of change: 06:00, July 28 to 15:00, July 28

Visibility	3,000 m	Showers,	Mist		
Clouds	Amount FEW	Type	Unknown	Cloud base	300 ft
	Amount BKN	Type	Unknown	Cloud base	800 ft

TEMPO Start time and end time of change: 15:00, July 28 to 21:00, July 28

Visibility	1,500 m	Thunderstorm,	Mist		
Clouds	Amount FEW	Type	Unknown	Cloud base	200 ft
	Amount BKN	Type	Unknown	Cloud base	500 ft
	Amount BKN	Type	Unknown	Cloud base	2,500 ft
	Amount FEW	Type	Cumulonimbus	Cloud base	2,500 ft

TEMPO Start time and end time of change: 21:00, July 28 to 06:00, July 29

Visibility	3,000 m	Showers,	Mist		
Clouds	Amount FEW	Type	Unknown	Cloud base	300 ft
	Amount BKN	Type	Unknown	Cloud base	800 ft

BECMG Start time and end time of change: 03:00, July 29 to 06:00, July 29

Wind direction	160°	Wind velocity	5 kt		
----------------	------	---------------	------	--	--

TEMPO Start time and end time of change: 06:00, July 29 to 09:00, July 29

Visibility	1,500 m	Showers,	Mist		
------------	---------	----------	------	--	--

\*<sup>3</sup> TEMPO applies to the weather condition changes which occur frequently or occasionally while each change lasts less than one hour and the total time of forecast conditions after the changes is less than half of the forecast period.

\*<sup>4</sup> BECMG applies to the changes of weather conditions within a period of time (one to four hours) where a regular/irregular change occurs and is followed by the last condition changed.

Clouds	Amount	FEW	Type	Unknown	Cloud base	200 ft
	Amount	BKN	Type	Unknown	Cloud base	500 ft
	Amount	BKN	Type	Unknown	Cloud base	2,500 ft
	Amount	FEW	Type	Cumulonimbus	Cloud base	2,500 ft

### 2.7.3 Aeronautical Weather Observation Data for Airports and Airfield

(1) Details of aeronautical weather observations around the time of the estimated off-block time of the Aircraft at Niigata Airport were as follows:

08:44 Wind direction 160° Wind velocity 9 kt  
 CAVOK\*5  
 Temperature 32 °C Dew point 21 °C  
 Altimeter setting (QNH) 29.88 inHg

(2) Details of aeronautical weather observations around the time of the accident at Sapporo Airfield were as follows:

09:00 Wind direction 140° Wind velocity 6 kt Visibility 15 km  
 Clouds Amount 1/8 Type Stratus Cloud base 800 ft  
 Amount 5/8 Type Cumulus Cloud base 4,000 ft  
 Amount 7/8 Type Stratocumulus Cloud base 6,000 ft  
 Temperature 26 °C Dew point 22 °C  
 Altimeter setting (QNH) 29.73 inHg

10:00 Wind direction 150° Wind velocity 11 kt Visibility 15 km  
 Clouds Amount 1/8 Type Stratus Cloud base 800 ft  
 Amount 5/8 Type Cumulus Cloud base 4,000 ft  
 Amount 6/8 Type Stratocumulus Cloud base 6,000 ft  
 Temperature 26 °C Dew point 22 °C  
 Altimeter setting (QNH) 29.72 inHg

11:00 Wind direction 150° Wind velocity 15 kt Visibility 15 km  
 Clouds Amount 1/8 Type Stratus Cloud base 900 ft  
 Amount 5/8 Type Cumulus Cloud base 4,000 ft  
 Amount 6/8 Type Altocumulus Cloud base 7,000 ft  
 Temperature 27 °C Dew point 22 °C  
 Altimeter setting (QNH) 29.71 inHg

(3) Details of aeronautical weather observations around the time of the accident at Okushiri Airport, located about 98 km northwest of the accident site, were as follows:

09:00 Wind direction 210° Wind velocity 14 kt Visibility 4 km  
 Weather Mist  
 Clouds Amount 2/8 Type Unknown Cloud base 300 ft  
 Amount 7/8 Type Unknown Cloud base 600 ft  
 Temperature 24 °C Dew point 22 °C

\*5 CAVOC is used when phenomena mentioned below simultaneously occur at the time of observation--visibility is over 10 km; there are no clouds at below 1,500 m (5,000 ft) or the maximum value of the minimum sector altitudes, whichever is higher; there are no important convective clouds; and there is no phenomenon specified in the meteorological abbreviation table.

The minimum sector altitude means the lowest allowable altitude set for emergencies with certain vertical separations--300 m (1,000 ft) for flat areas and 600 m (2,000 ft) for mountainous areas--from all objects of obstacle which exist in an area included in a circle with a radius of 25 nm around the navigation radio facility involved. This value differs from airport to airport and the maximum value at Niigata Airport is 9,000 ft.

	Altimeter setting (QNH)	29.74 inHg				
10:00	Wind direction	210°	Wind velocity	14 kt	Visibility	4 km
	Weather	Mist				
	Clouds	Amount 1/8	Type Unknown	Cloud base	300 ft	
		Amount 3/8	Type Unknown	Cloud base	400 ft	
		Amount 7/8	Type Unknown	Cloud base	600 ft	
	Temperature	23 °C	Dew point	22 °C		
	Altimeter setting (QNH)	29.72 inHg				
11:00	Wind direction	210°	Wind velocity	17 kt	Visibility	4.5 km
	Weather	Mist				
	Clouds	Amount 1/8	Type Unknown	Cloud base	300 ft	
		Amount 3/8	Type Unknown	Cloud base	500 ft	
		Amount 7/8	Type Unknown	Cloud base	800 ft	
	Temperature	24 °C	Dew point	22 °C		
	Altimeter setting (QNH)	29.72 inHg				

(4) Details of aeronautical weather observations around the time of the accident at Hakodate Airport, located about 46 km northeast of the accident site, were as follows:

10:00	Wind direction	230°	Wind velocity	15 kt	Visibility	6 km
	Clouds	Amount 1/8	Type Stratus	Cloud base	800 ft	
		Amount 3/8	Type Stratus	Cloud base	1,800 ft	
		Amount 7/8	Type Unknown	Cloud base	Unknown	
	Temperature	24 °C	Dew point	23 °C		
	Altimeter setting (QNH)	29.77 inHg				
11:00	Wind direction	230°	Wind velocity	9 kt	Visibility	5 km
	Weather	Mist				
	Clouds	Amount 1/8	Type Stratus	Cloud base	800 ft	
		Amount 3/8	Type Cumulus	Cloud base	2,500 ft	
		Amount 7/8	Type Unknown	Cloud base	Unknown	
	Temperature	24 °C	Dew point	23 °C		
	Altimeter setting (QNH)	29.77 inHg				

(5) Details of aeronautical weather observations around the time of the accident at Akita Airport were as follows:

10:00	Wind direction	200°	Wind velocity	5 kt		
	Wind deflection	150° to 240°	Visibility	15 km		
	Clouds	Amount 1/8	Type Cumulus	Cloud base	2,000 ft	
		Amount 5/8	Type Stratocumulus	Cloud base	5,000 ft	
		Amount 7/8	Type Unknown	Cloud base	Unknown	
	Temperature	28 °C	Dew point	23 °C		
	Altimeter setting (QNH)	29.88 inH				

(6) Details of aeronautical weather observations around the time of the accident at Oodate-Noshiro Airport were as follows:

10:00	Wind direction	200°	Wind velocity	10 kt	Visibility	20 km
	Clouds	Amount 1/8	Type Cumulus	Cloud base	2,000 ft	
		Amount 3/8	Type Cumulus	Cloud base	3,000 ft	
		Amount 6/8	Type Stratocumulus	Cloud base	5,000 ft	

Temperature 27 °C Dew point 23 °C  
Altimeter setting (QNH) 29.85 inH

(7) Details of aeronautical weather observations around the time of the accident at Aomori Airport were as follows:

10:36 Wind direction 230° Wind velocity 19 kt  
Maximum momentary wind velocity 29 kt Visibility 25 km  
Clouds Amount 2/8 Type Cumulus Cloud base 3,000 ft  
Amount 7/8 Type Unknown Cloud base Unknown  
Temperature 28 °C Dew point 19 °C  
Altimeter setting (QNH) 29.82 inH

#### 2.7.4 Weather Condition Observed by a Resident about 7 Km North of Accident Site

A resident who was about 7 km north of the accident site mentioned the weather condition around the site as follows:

He stayed outdoors until past noon. It was cloudy and strong southerly winds were blowing. Mountain ridges of Mt. Tomyo-dake (elevation 578 m) and Mt. Maruyama (elevation 665 m) to the south were visible. He observed sunshine in the east while black rain clouds were coming over the western mountain ranges.

(See Figure 3 Oshima Peninsula Area Layout)

#### 2.7.5 Weather Condition Observed by the Company's Pilot

A Company's pilot (hereinafter referred to as "the Pilot A"), who was in the northern part of the Oshima region about 80 km north of the accident site, described the weather condition in the Oshima-Hiyama region on the day of the accident as follows:

The Pilot A planned to fly in the northern part of the Hiyama region on the day. He waited for the improved weather condition in the morning. Weather was good in the east ranging from Funka Bay to Hakodate and even to Ooma-machi, Shimokita-gun, Aomori Prefecture. But the live feed from a monitoring camera before noon installed near Unseki Pass (elevation about 2,000 ft) on National Highway 277 showed stratus-like low clouds at about 1,000 ft spreading from the Sea of Japan with a visibility of about 10 km. As the weather improved slightly later, he went airborne around 12:25. But the rain made him stop flying after 10 minutes.

Later he flew southward to Shiriuchi-town and Fukushima-town roughly from 16:30 to 18:30 in search for the missing aircraft. When he flew over Nakayama Pass en route to Shiriuchi-town, he could fly as high as about 3,000 ft. With the visibility of 10 to 15 km, he could see the areas across Hakodate. When he was flying from Shiriuchi-town to Fukushima-town, the area to the west including Mt. Daisengen-dake was not visible. Mt. Daisengen-dake (elevation about 3,500 to 3,600 ft) was not visible except its mountain slopes less than 2,000 ft due to low-hanging clouds. The weather condition to the west was considerably bad.

The condition was the same near the accident site. The slope on the southern side was fogged, and winds from the south or the southwest were blowing at 10 to 15 m/s. Flight on the side of Shiriuchi-town was fairly bumpy due to downdraft which came from a ridge extending from Mt. Iwabe-dake. By contrast the aircraft experienced strong updraft on the side of the southern coastline. Dense fog were flowing up along the mountain slope. Visibility on this side



was not bad and the coastline far ahead was visible.  
(See Figure 3 Oshima Peninsula Area Layout)

### 2.7.6 Weather Condition Observed by SAR Pilot

A pilot (hereinafter referred to as “the Pilot B”) who searched for the missing aircraft with an airplane, described the weather condition during the search flight over around the accident site from about 14:25 to 16:15 on the day as follows:

The Pilot B took off from Hakodate Airport and flew over a mountain with an elevation of about 3,500 ft in the Matsumae Peninsula at about 5,500 ft. But the cumulus-like cloud cover prevented him from seeing the ground. Therefore, he descended over the Tsugaru Straits and tried to fly toward the mountains near the accident site. But low-hanging clouds blocked his attempt.

The Pilot B guessed that with an altitude of 10,000 ft it would be able to fly to Sapporo Airfield.

He flew along the coastline on the Sea of Japan at about 500 ft. Onboard weather radar detected a precipitation area northern side of Shakotan Peninsula. The area south of the Peninsula was sporadic rain area. Strong southwesterly or southerly winds were blowing at about 30 kt over the sea.

Cloud base on the mountain was about 2,000 ft. With reduced visibility ridge lines were not visible. Patches of clouds were over the Matsumae Peninsula, while there were some cloudless areas over the Tsugaru Straits.

(See Figure 3 Oshima Peninsula Area Layout)

## 2.8 Information about Flight Plan and Operation Services

### 2.8.1 Jobs Performed by PIC before Accident

According to the manager of the operation control department and other persons at the Company’s head office at Nagoya Airfield, details of jobs performed by the PIC before the accident were as follows:

The PIC took a day off on July 25. On June 26 he boarded the Aircraft along with the passenger for a survey flight. He performed local flights around Nagoya Airfield and Kohnan Airfield. On July 27, he made a ferry flight from Kohnan Airfield to Niigata Airport.

If weather was favorable, the PIC planned to make a ferry flight from Niigata Airport to Sapporo Airfield on the same day. But after receiving a weather briefing from a pilot who arrived from Sapporo Airfield at the Company’s Niigata office, he canceled the flight to Sapporo Airfield that day.

The purpose of the flight after the arrival Sapporo Airfield was aerial photo mission over inland areas in Hokkaido. The work required four to five days with five to six flight hours a day under favorable weather conditions. Arrangements with the ATC organization involved had been made so that the photo mission would be carried out between July 26, 2010 and September 30, 2010.

### 2.8.2 Aircraft Operation Control at Niigata Airport

According to an operation controller at the Company’s Niigata office (hereinafter referred to as “the Controller A”), details of the PIC’s actions from the arrival of the Aircraft at Niigata Airport on July 27, 2010 to the departure of the Aircraft on the day of the accident were as follows:

On July 27, one day before the accident, the Aircraft was ferried from Kohnan Airfield by the PIC and it arrived at Niigata Airport at 11:35 and was refueled. Because of the absence of a mechanic stationed at Niigata office on July 27 and 28, and of no mechanic on board the Aircraft, the Controller A thought that a post-flight check of the Aircraft was done by the PIC himself. Later the PIC collected weather information from the contracted weather service website at the office and confirmed the weather condition. He finished his duty for the day at Niigata Airport.

When the Controller A went to work around 08:15 on the day of the accident, the Aircraft had already been pulled out from the hanger to the apron and the PIC was checking the weather condition. After a little while, the Controller A received a flight plan from the PIC and at that time, the PIC had told the Controller A that he would depart before the weather condition worsens.

The PIC did not consult with the Controller A about weather information and the flight plan, nor did he explain about the flight plan. The PIC completed the flight plan by himself.

The Controller A acknowledged the flight plan received from the PIC and sent it to an operation controller at the Company's head office (hereinafter referred to as "the Controller B") with facsimile and then, uploaded it to the air traffic authority after getting confirmation from the Controller B.

Niigata office received a take-off report from the PIC and was asked to provide the data of aeronautical weather observations for Sapporo Airfield and Okushiri Airport as of 09:00 as soon as they are available. The Controller A provided the weather information to the Aircraft via the Company radio. Weather at Okushiri Airport was bad, but there was no comment from the PIC.

It was a VFR flight over a long route extended from south to north and taking long flight hours. There are many airports along the en-route. The weather conditions were expected to be worsening as the time passes. On the day of the accident the weather conditions along the route was favorable except in Hokkaido. The company radio's possible coverage extends as far as the border between Yamagata and Akita Prefectures. The Controller A thought that the PIC would fly based on his judgment when the Aircraft went out of the radio coverage.

### **2.8.3 Operation Control for the Aircraft at Section for Operation Control at the Company's Head Office**

Details of operation control for the Aircraft by the Controller B who had received the flight plan at the Company's head office were as follows:

The department in charge of operation control receives flight plans with facsimile from local offices and other concerning facilities and authorizes them upon confirming relevant weather and flight routes.

On the day of the accident, the weather conditions of the destination and en-route airports were not so bad. Also because it was one of the busiest morning time frame for operation-related personnel to handle air fleets, the Controller B could not spare time for operation monitoring after the take-off of the Aircraft. But when he looked at the bulletin board used to update the flight operations, he found information from an FSC being updated and found that the Aircraft had passed Tappizaki. He thought the Aircraft would arrive the destination soon.

As far as the flight route of the Aircraft is concerned, he recalled that an airplane could take such a flight route traveling from Motta to Shakotan Promontories while helicopters usually fly from Ooma to Hakodate.

There are many airports available along the route. Therefore, he thought that as the flight progressed, weather information at the destination aerodrome could be obtained from the ATC

facilities when necessary. Also because the Aircraft was flying VFR, he thought that the Aircraft would keep away from clouds, and in case of bad weather along the future route it would fly back because it was loaded with ample amount of fuel.

The head office at Nagoya Airfield cannot provide operational support with radio to the Aircraft flying from Niigata Airport to Sapporo Airfield due to the radio coverage. Although this is done by the Niigata office, its radio coverage is also limited. In the areas north of the Niigata office, the Okadama office at Sapporo Airfield is the only facility of this kind. When The Company sends a message to its aircraft flying in an airspace with no radio coverage, there is a way in that it may ask the FSC to relay its message to it. However, this is not a common practice.

## **2.9 Information about Communication**

Communication between the Aircraft and the Sendai FSC, and also the New Chitose FSC, was normal.

## **2.10 Information about Radio Systems**

### **2.10.1 VHF Radios**

Frequencies set for the Aircraft's No.1 VHF radio were as follows: The No.2 VHF radio was too damaged to display frequencies set.

#### **(1) Frequencies for Communication**

Usable frequency 127.10 MHz (New Chitose FSC Yokotsudake Broad-Area Ground-Air Site)

Standby frequency 134.75 MHz (New Chitose FSC Okadama Broad-Area Ground-Air Site)

#### **(2) Frequencies for Navigation**

Usable Frequency 109.85 MHz (Okushiri VOR/DME)

Standby Frequency 112.30 MHz (Hakodate VOR/DME)

### **2.10.2 Emergency Locator Transmitter**

The Aircraft was equipped with an emergency locator transmitter (ELT). The main unit was installed inside of the aft part of the fuselage, while the antenna was installed on the outer upper side near the main unit. The switch was in the normal "Armed" position.\*6

A distress signal from the ELT was received around 11:46 on July 30 by an SAR aircraft over the accident site.

## **2.11 Information about the Accident Site and Wreckage**

### **2.11.1 Accident Site**

The accident site was near a ridge with an elevation of about 750 m (about 2,460 ft) on a mountain range extending from Mt. Maruyama to Mt. Iwabe-dake. The wreckage scattered in an area about 92 m long and about 12 m wide in the direction of about 140° on both sides of the ridge.

Of the damaged trees at the accident side, the tree at the farthest place to the northwest (hereinafter referred to as "the Tree A") had branches near its top broken. Broken pieces of the right wing tip were found on the ground near its root. The elevation of the broken branches of the Tree A

---

\*6 The "Armed" means that various functions for aircraft, such as safety and autopilot systems, will operate when preset conditions are met. In this case it means that the ELT is in a condition where it will be activated in an emergency.

was about 751 m (this includes about 12 m for the height of the damaged branch from the ground).

Broken pieces of the left horizontal tail wing were found at a place about 23 m southeast from the Tree A, while broken pieces of the right horizontal tail wing were found at a place about 44 m from there.

At the root of a tree near the ridge about 49 m southeast of the Tree A (hereinafter referred to as “the Tree B”) was the left main wing being detached from the fuselage and turned over. The trunk of the Tree B was found to have been bit with an area of the wing base connected to the fuselage. The left main landing gear was near the Tree B. There was an impact scar on the tree trunk of the Tree B about 4 m from the ground. The impact scar’s elevation was about 749 m.

The propeller was found at the place about 13 m southeast from the Tree B.

A tree about 21 m southeast of the Tree B (hereinafter referred to as “the Tree C”) had an impact scar about 3 m from the ground. The impact scar was at an elevation of about 743 m. The engine compartment fire wall, the instrument panel and the nose landing gear were found on the ground near the root of the Tree C.

An area between the Tree A and the Tree C was a dense wood. There were no trees near the wreckage on a steep slope east of the Tree C.

The empennage and the right main wing were found at a place with an elevation of 730 m about 6 m southeast of the Tree C.

The fuselage, orienting to the west, lay on its right side at a place with an elevation of about 720 m about 22 m southeast of the Tree C.

The engine was next to a rock with a diameter of about 2 m on a steep slope about 12 m northeast of the fuselage.

There was no trace of fire at the accident site.

The SAR organization provided the occupant information as follows:

The PIC was found lying on his stomach next to the Aircraft fuselage, while the passenger was in the front seat bending forward with his seat belt fastened.

(See Figure 2 Accident Site Layout, Photo 2 Left Main Wing, Photo 3 Propeller, Photo 4 Instrument Panel, Photo 5 Empennage and Right Main Wing, Photo 6 Fuselage, Photo 7 Engine)

### **2.11.2 Details of Damage**

- (1) The engine compartment fire wall, the instrument panel, the nose landing gear, the left main landing gear and both pilot seats were detached from the fuselage. The ceiling of the cabin room, the forward cover including the windows, the cover on the left side of the fuselage including the left side door were deformed, detached or dropped off. The left side of the fuselage, including its aft part, was found more severely dented and damaged than that of the right side.
- (2) The propeller was detached from the attachment to the engine. All the three blade tips had irregular deformations. Each blade showed different pitch alignment.
- (3) The engine was torn off from the fuselage and from the damaged engine cowling. Its whole exterior was damaged.
- (4) Both main wings were each found detached from the fuselage. The whole parts of the wings had cracks and ruptures. The leading edge of both main wings had traces of roughly perpendicular impact scars with deep cylindrical dents.

Both main wings had cracks and ruptures due to damage. There was no fuel left in the

wing fuel tanks.

(5) The empennage, including the tail cone, was detached from the fuselage. The Empennage, being damaged over the whole sections, were broken into several pieces.

(6) The ELT radio component, which was installed inside of the aft fuselage, had no major damage. The antenna installed on the aft fuselage outer skin was broken at the base.

(See Photo 2 Left Main Wing, Photo 3 Propeller, Photo 4 Instrument Panel, Photo 5 Empennage and Right Main Wing, Photo 6 Fuselage, Photo 7 Engine)

## **2.12 Medical Information**

The Hokkaido Prefectural Police provided the information on fatal causes for the two occupants as follows:

The PIC died of a traumatic shock. His blood sample tested negative for alcohol or illegal drug.

The passenger died of a cerebral contusion.

## **2.13 Information on SAR Operation**

According to the Civil Aviation Bureau (CAB), MLIT, information concerning SAR operation was as follows:

As the Aircraft did not arrive at the destination aerodrome even after the estimated arrival time of 12:49, the Okadama Airport Office of the Tokyo Regional CAB, MLIT which is located at Sapporo Airfield, reported the situation to the Tokyo Rescue Coordination Center (RCC) at the Tokyo Airport Office, the Tokyo Regional CAB at 13:07.

The RCC, upon receiving the report, started a communication search at 13:19, 30 minutes after the estimated arrival time. At 14:19, the time of the Aircraft's fuel exhaustion, the RCC requested SAR organizations to start a disaster relief operation.

From the afternoon of July 28 to the dawn of July 30, it was raining in the Oshima-Hiyama region and the mountainous areas in the region were under cloud cover. There were no positive reports of aircraft sighting. The absence of distress signal from the Aircraft's ELT made it difficult to locate the whereabouts of the Aircraft, leading to the widened area of search to regions from the Tsugaru Straits to the whole Oshima Peninsula. A reception of the ELT distress signal lead to a positive crash of the Aircraft by a SAR helicopter which was flying under favorable cloud conditions around 11:46 on July 30. The bodies of the PIC and the passenger were recovered.

Organizations mobilized for the SAR operation included Hokkaido Prefectural Police, the Hokkaido prefectural government, the Japan Coast Guard, the Self-Defense Forces and the Company itself, with 16 aircraft, 28 helicopters, 11 ships, 84 vehicles and 317 persons.

## **2.14 Information on the Aircraft's Operation**

(1) The manager at the Company's Airplane Operation Department stated his views on the Aircraft's operation as follows:

The Aircraft was equipped with a VOR/DME receiver and the PIC had a valid instrument flight certificate, making the Aircraft IFR flyable. Equipped with a turbo-charger and an oxygen supply system, it was able to fly at high altitudes surpassing 10,000 ft. Accordingly, in a weather condition with many clouds observed at low altitude, such as seen at the time of the accident, it was possible for the Aircraft to request for a radar vector toward Hakodate Airport after climbing on top. The Aircraft could return to Aomori Airport with radar vector if it hoped to go to an area of a good weather condition.

Although the Aircraft can fly IFR, it was not assumed for this class of single-engine aircraft to fly IFR by a single pilot on board. The change of flight rules from VMC to IFR under difficult VMC conditions, it was purely an emergency action for the Aircraft whose equipment is as mentioned above.

The PIC seemed to have judged that it would be all right if he could somehow maintain the visual contact of the ground and dared not to climb to a higher altitude.

The PIC flew IFR when he returned to Nagoya Airfield after finishing his flight duties, mainly by receiving radar vector or instrument approach and landing. But because of his long career of aerial photo-mission and aerial survey and not flying under adverse weather conditions, he lacked an appropriate judgment necessary for bad weather.

After the accident, the Company's pilots were interviewed about the PIC's flying habits, and the result revealed that he had a tendency to dodge clouds by lowering the altitude and fly visually confirming the ground under bad weather conditions.

As the PIC arrived at Niigata Airport the previous day, he was believed to have obtained information at an early stage that Okushiri Airport weather was unfavorable, and by that time he realized that it would be difficult to fly along the western coast. The PIC's tentative judgment then was to fly north along the coast as far as the weather permitted, maybe to Hakodate Airport because its weather forecast was not bad.

On the day of the accident, one of the Company's helicopter took off from Hakodate Airport and did a flight mission from the eastern tip of the Oshima Peninsula to the Shimokita region under somewhat favorable weather conditions. This activity was not relayed to the PIC. Both the helicopter pilot and the PIC had no idea with each other that Company's another aircraft was nearby. As far as the information management capability at the head office is concerned, the less it becomes centralized the farther aircraft concerned operate away from Nagoya, as they operate migrating from one place to another.

After arriving at Sapporo Airfield, the Aircraft was planned to do survey flights. But at the time of the accident there were no specific instructions for its flight when to start flying. There was no need for the Aircraft to arrive there hurriedly because there was no guarantee for favorable weather conditions even after the hurried arrival there. But because weather was relatively good at Sapporo Airfield, the PIC supposedly hoped to arrive at Sapporo somehow flying through a bad weather area over the Oshima Peninsula. (See Figure 3 Oshima Peninsula Area Layout)

- (2) The Company provided the PIC's flight records and the Aircraft's flight plans as follows:
  - a. The PIC ferried an aircraft from Nagoya to Sapporo Airfield April 2010. Then he performed a survey flight for a total of six days; 26 hrs. and 15 min. along the Sea of Japan coasts in Hokkaido and returned to Nagoya Airfield. The PIC joined the Company in 2003. There are no other records of flights for him in Hokkaido area during his years with the Company. The Company has no records whether he had flown in Hokkaido or not before joining the Company.
  - b. IFR flight records of a total of 6 hrs. and 0 min. for nine days since March 27, 2010 were logged in his logbook, which were done on flight routes.
  - c. There were no flight operations scheduled along the western coasts of Hokkaido after the arrival of Sapporo Airfield.

## 2.15 Information on the Flight Manual

The flight manual stipulates the operating limitations and icing as follows: (Expert)

### *Section 2 Limitations*

#### *2-7 Other limitations*

##### *2-7-1 Operating Limitations*

*The aircraft with the following equipment installed can fly the following operations. (See Attachment 4 Operating Limitation Decision Table)*

*IFR flight*

*Instrument flight*

*Flight with instrument navigation*

*Visual flight other than instrument navigation*

*Daytime VFR flight*

*Night flight*

*High-altitude flight (over an altitude of 3,000 m)*

*(Note)*

*Flight into known icing conditions is prohibited.*

### *Section 3*

*Emergency operations of necessary equipment*

#### *3-1 Introduction*

*This section provides checklists and detailed explanation for emergency situations. Emergencies caused by airplane or engine malfunctions are extremely rare as long as proper preflight inspections and maintenance are practiced. An en-route encounter of adverse weather can be minimized or eliminated by careful flight planning and good judgment. Should an emergency arise, apply the basic guideline described in this section.*

#### *3-3 Operation checklist for emergencies*

##### *3-3-4 Icing*

###### *1 Inadvertent icing encounter*

*(2) Turn back or change altitude to fly into the airspace where icing can be eliminated.*

*(6) If icing conditions are unavoidable, plan to land at the nearest airport. With an extremely rapid ice build-up, select a suitable "off-airport" landing site.*

#### *3-4 Details of emergency operation procedure*

##### *3-4-6 Inadvertent flight into icing conditions*

*Flight into icing conditions is prohibited. Take suitable actions based on the checklist procedures when encountered with these conditions. The best procedure, of course, is to turn back or change altitude to escape icing conditions.*

*(Omitted)*

(See Figure 11 Operating Limitation Decision Table)

## 2.16 Information on the Company's Operation Service Procedure I

The Operation Service Procedure I, an attachment to the Operation Manual I which was established per the provisions of the Civil Aeronautics Act of Japan, has the following descriptions on the standards for the execution of flight operations. (Excerpts)

## Chapter 3 Operation Management

### 3.2 Assignment of Operation Controller

1. The company shall assign an operation controller at the head office (Nagoya Airfield) for operation control and assistant operation controllers at the head office and local offices.

### 3.3 Scope and Detailed Job Description for Operation Controllers

#### 2. Jobs before Flight

##### (2) Collection of Information

The operation controller confirms crewmembers' attendance at work. His information collection includes the latest weather, aeronautical information including air traffic information in the area of flight operation, information about airports, flight obstacles and aircraft for use.

Special attention must be paid to the movements of fronts, turbulence, thunder storms, precipitation, and fog.

- (3) The operation controller provides PICs with information necessary for safe operation of aircraft (except when information is provided by assistant operation controller) and assists PIC's flight plan completion.

The controller provides air traffic information in the area of flight operation to a PIC.

#### 3. Jobs during Flight

##### (2) Flight Monitor

Operation controller maintains flight monitoring over the aircraft which fall in his responsibility. If necessary, he shall change the flight plan consulting the PIC involved.

- a. At the head office, the operation controller monitors flights through company radio.
- b. At a local office, assistant operation controller monitors flights through company radio and reports operation status to the controller at the head office.
- c. When an aircraft is out of company radio coverage, an assistant controller confirms its status with the help of FSC and sends a report to the head office.
- d. When air traffic information relevant to a flight area is obtained, controllers provide it to the PIC without delay.

##### (3) Maintain readiness to Assist Aircraft

The company maintains radio monitoring all the time while aircraft are in the air.

Operation controllers provide aeronautical information and every kind of assistance to an aircraft through the radio after it leaves a ramp area, sometimes by arranging direct communication with a mechanic under engine/ other mechanical trouble situation.

## Chapter 4 Implementation of Flight

### 4.2 Requirements for Flight Plans

#### 4.2.1 Flight Rules

##### 1. Selection of a Flight Rule

A PIC can choose either visual flight rules (VFR) or instrument flight rules (IFR).

##### 2. In-Flight Flight Rule Change

###### (1) VFR to IFR

When it is expected during a VFR flight that the meteorological condition on the route or at the destination aerodrome drops to IMC, or when a PIC has a positive judgment of IFR flight to be appropriate, he can continue the flight after changing



*flight rules from VFR to IFR through the process of reporting the present position and the altitude to the air traffic control facility involved and getting a new altitude and flight route while maintaining VFR.*

#### *Chapter 10 Minimum Safe Flying Altitude*

##### *10.2 VFR Flight*

- 1. (Omitted) When an aircraft encounters a condition where it is difficult to fly maintaining a certain altitude, it shall turn back to the departure aerodrome without delay or land on the nearest appropriate landing site.*

#### *Chapter 15 Company Flight*

##### *15.1 General*

*The company shall (Omitted) establish the following matters for company flights (operations for the sake of the company):  
(Omitted)*

##### *15.2 Division of flights*

*Flights shall be divided as follows:*

- 1. Ferry flight  
(omitted)*

##### *15.3 Operation Control*

*Company flights are operation controlled as that for air transport services.*

##### *15.5 Meteorological Condition*

*Unless otherwise stated, the minimum meteorological conditions established or authorized by airport/other control authorities applies, regardless of a PIC's licenses or aircraft capabilities.*

##### *15.6 Flight Rules*

- 1. Either VFR or IFR shall apply.*
- 2. Limitations on VMC ON TOP\*<sup>7</sup>*

*In principle, no VMC ON TOP flight is authorized. However, this excludes daytime flight trainings in a training air space.*

## **2.17 Laws and Ordinances about IMC and VMC**

Article 5 of Ordinance for Enforcement of the Civil Aeronautics Act stipulates that IMC are meteorological conditions other than VMC. The ordinance stipulates VMC as follows: (Excerpt)

### *Article 5*

*(ii) Aircraft that flies at an altitude less than 3,000 meters (excluding aircrafts listed in the following item (Omitted))*

*(b) that aircraft flies in the airspace other than control area, control zone and information zone; Weather conditions that meet requirements: (Omitted)*

- 1. that flight visibility is over than 1,500 meters.*
- 2. that no cloud is within the vertical distance of 150 meters above and 300 meters below the aircraft.*
- 3. that no cloud is within the horizontal distance of 600 meters from the aircraft.*

*(iii) Aircraft that flies at an altitude less than 300 meters from the ground surface or the*

---

\*<sup>7</sup> VMC ON TOP means a visual flight on top of the cloud cover.

*water surface in the airspace other than the control area, the control zone and the information zone (Omitted); Weather conditions that meet requirements: (Omitted)*

*(a) That flight visibility is over than 1,500 meters.*

*(b) That aircraft may fly away from clouds and that the pilot may visibly recognize the ground surface or the water surface.*

## **2.18 Laws and Ordinances about Minimum Safety Altitude**

### **(1) Civil Aeronautics Act**

The minimum safety altitude is stipulated in the Civil Aeronautics Act as follows: (Excerpt)

*Article 81 No aircraft shall be flown, except during taking off or landing, at an altitude lower than that specified by Ordinances of the Ministry of Land, Infrastructure, Transport and Tourism, taking into consideration the safety of persons or objects on land or water as well as the safety of aircraft. (Omitted)*

### **(2) Ordinance for Enforcement of the Civil Aeronautics Act**

The minimum safety altitude is stipulated in Ordinance for Enforcement of the Civil Aeronautics Act as follows: (Excerpt)

*Article 174 The minimum safety altitude pursuant to Article 81 of the Act shall be as follows:*

*(i) In case of aircraft navigating on a visual flight rules shall take any of the highest of altitude at which landing is feasible, when power system only has stopped during a flight, without causing danger of human beings or objects on the ground or on water and the following altitudes:*

*(a) (Omitted)*

*(b) In the case of above an area without human beings or houses, an altitude at which an aircraft can continue flight while maintaining a distance of 150 meters or more from human beings or objects on the ground or on water.*

*(c) In the case of aircraft navigating by instrument navigation system, the altitude set forth by a public notice.*

## **3. ANALYSIS**

### **3.1 Qualification of Personnel**

The PIC held a valid airman competence certificate and a valid aviation medical certificate.

### **3.2 Airworthiness Certificate of the Aircraft**

The Aircraft had a valid airworthiness certificate and had been maintained and inspected as prescribed.

### **3.3 Meteorological Conditions**

#### **3.3.1 Confirmation of Weather Condition before and after Departure by PIC**

- (1) As described in 2.8.1, one day before the occurrence of the accident, the PIC refrained from flying on to Sapporo Airfield after receiving a weather briefing from the Company's other pilot who had flown from Sapporo. Therefore, it is probable that the PIC had paid attention to the weather conditions.

- (2) Regarding the weather condition along the planned route on the day of the accident, the weather outlook described in 2.7.1 had a forecast that it would be cloudy and raining past noon, and some areas would observe fogs with thunders because Oshima-Hiyama region of Hokkaido was under a trough. The TAFs observed at New Chitose Airport and Hakodate Airport as described in 2.7.2, showed that the visibility and the cloud base had a tendency to become smaller and lower with thunderstorm forecast with a cumulonimbus past noon.

As described in 2.8.2, when the PIC submitted the flight plan, he had told that he would depart before weather worsens.

These findings suggest that the PIC had probably judged that weather in the Hokkaido region would worsen as time goes by.

- (3) As described in 2.8.2, the Controller A stated that he had not consulted with the PIC about meteorological information on the day. Therefore, it is probable that the Controller A had no consultation with the PIC about meteorological information.
- (4) As described in 2.1 and 2.8.2, the flight was under VFR, and after the takeoff the PIC asked the Controller A to provide information about the aeronautical weather observations at Sapporo Airfield and Okushiri Airport as of 09:00 and received it. Therefore, it is probable that as described in 2.7.3 (2) and (3), the PIC had recognized then that there would be no problem with weather at Sapporo Airfield as the destination aerodrome but that weather would be bad at Okushiri Airport, and it is probable that the PIC had recognized that it would be difficult to fly on the route along the western coast of Hokkaido.
- (5) Judging from the reasons mentioned below, the PIC should not have decided to have a VFR flight for Sapporo Airfield on the day of the accident.
1. As described in 3.3.1 (2), when the PIC submitted the flight plan, he said that he would depart before weather worsens. Therefore, it is probable that the PIC was aware that the weather in Hokkaido would worsen as time goes by.
  2. As described in 2.8.1 and 2.14 (1), the purpose of the Aircraft's flight after its arrival at Sapporo Airfield was a survey flight in inland areas. Therefore, it is probable that the flight would be impossible in a bad weather condition.

### **3.3.2 Meteorological Condition during Flight**

- (1) Meteorological Condition from Niigata Airport to Tsugaru Straits

The history of flight as described in 2.1 and the aeronautical weather observations at the airports and airfields involved as described in 2.7.3 (1), (5), (6) and (7) suggest that the Aircraft could fly VFR along the coastline from Niigata Airport to front of Oshima Peninsula over the Tsugaru Straits.

- (2) Meteorological Condition around Oshima Peninsula

The Asia-Pacific Surface Analysis Charts as of 09:00 and 15:00 on July 28, the Meteorological Satellite Imageries for Japan Area as of 10:30 and 15:00, and the Radar Echo Charts as of 10:40 and 15:00 that were described in 2.7.1 suggest no significant changes in the atmospheric pressure pattern and the isobaric contour lines around Oshima Peninsula. This suggests that although the general weather tendency around Oshima Peninsula including the accident site was worsening, almost the same weather condition continued in the period of time involved. So it is somewhat likely that almost the same kind of weather condition continued from around 10:37 when the Aircraft was flying over the Tsugaru Straits as described in 2.1 to the time when weather was observed by the Pilot A and B, who

were in the northern part of the Oshima Peninsula as described in 2.7.5, and as described in 2.7.6, respectively.

(3) Cloud Conditions over Sea off Southwestern Part of Oshima Peninsula

The aeronautical weather observations at Okushiri Airport described in 2.7.3 (3) as of 11:00 was a cloud amount of 7/8 with the cloud base of 800 ft accompanied by sporadic clouds at even lower altitudes, which was roughly coinciding with the loss of the Aircraft target symbol from the ATC display at 10:39:52. The Pilot B stated in 2.7.6, that he flew at about 500 ft along the coast on the Sea of Japan for the SAR operation around 14:25 through 16:15. Considering the description in 3.3.2 (2), it is somewhat likely that a similar weather condition was observed at the time of the accident.

Judging from these findings, it is somewhat likely that around 10:40 when communication with the Aircraft was lost, the sea off the southwestern part of the Oshima Peninsula was covered with low clouds.

(4) Cloud Condition over Mountainous Area in Southwestern Part of Oshima Peninsula

The Radar Echo Chart as of 10:40 showed a small raining zone near the accident site.

The resident who was about 7 km north of the accident site stated as described in 2.7.4 that rain clouds had begun to appear on mountains near the accident site. The Pilot A who was in the northern part of the Oshima Peninsula stated as described in 2.7.5 that weather had been bad from the morning in the Hiyama region in the western part of the Oshima Peninsula, with stratus-like clouds hanging low. The Pilot B stated, as described in 2.7.6, the Matsumae Peninsula was covered with clouds from an altitude of about 2,000 ft to near 5,500 ft during the SAR operation around 14:25 through 16:15. Considering the description in 3.3.2 (2), it is somewhat likely that a similar weather condition was observed at the time of the accident.

Judging from these findings, it is somewhat likely that clouds were covering the ridges in the mountainous areas in the southwestern part of the Oshima Peninsula.

### **3.4 Development of Flight**

#### **3.4.1 Flight Route Flown until Crash**

- (1) As described in 2.1, it is highly probable that the Aircraft was flying almost on the route described in the flight plan from Niigata Airport to Tappizaki.
- (2) As described in 2.1, the Aircraft's target symbol on the ATC radar display disappeared east-southeastward from the last known position at about 2,500 ft over the southwestern part of Oshima Peninsula and its flight track terminated.

As the distance from the last known position on the radar display and the accident site was several hundred meters, it is highly probable that the Aircraft crashed several seconds after the disappearance on the ATC radar display.

#### **3.4.2 Crash Sequence**

Judging from the condition at the accident site as described in 2.11.1, the crash sequence developed probably as follows:

- (1) Of the damaged trees at the accident site, branches near the top of the Tree A which stands farthest to the northwest was broken. Meanwhile, broken pieces of the right wing tip were found on the ground near the tree. This fact indicates that the Aircraft had its right wing tip hit the Tree A during the maneuver.

- (2) Following the contact with the Tree A, the Aircraft maneuvered straight toward the Tree C near the ridge. Its airframe parts were ripped away from the fuselage upon impact with trees which grow densely between the Tree A and C.
- (3) The detached empennage, the right main wing, the fuselage and the engine landed and slid down a steep slope beyond the Tree C and came to a halt.

Judging from the impact marks left near the top of trees near the ridge, it is probable that the Aircraft's flight track until the crash was almost level.

### **3.5 Judgment by PIC until Crash**

#### **3.5.1 Plan for Flight Route via Western Coast of Hokkaido**

According to the information regarding the Aircraft's operation as described in 2.14, no flight along the western coast of Hokkaido was scheduled after the arrival at Sapporo Airfield. Therefore, the ferry flight route via the western coast of Hokkaido was probably not a preliminary survey flight for the expected mission.

Probable reasons why the PIC had selected the flight route via the western coast of Hokkaido probably include the following:

- (1) As described in 2.14(2) a., the PIC did a survey flight along the Sea of Japan coast of Hokkaido once after joining the Company; however, he had no other flight experience in the region.
- (2) The PIC judged that the visibility in Hokkaido was expected to be bad on the route from Niigata Airport (on the Sea of Japan) to Sapporo Airfield considering the weather information described in 3.3. Therefore, he selected the route which enables him to have visual contact with the coastline on the Sea of Japan.

#### **3.5.2 Advance to Mountainous Area in Oshima Peninsula**

Judging from the meteorological information described in 3.3 and the information on the Aircraft's operation described in 2.14, it is somewhat likely that the PIC made decisions as described below during his flight from Tappizaki to the mountainous area in the Oshima Peninsula followed by the crash:

- (1) During the flight up to Tappizaki the Aircraft had an uneventful flight at about 3,500 ft. But ahead over the Oshima Peninsula there were many clouds, particularly the sea off the western coast of the Oshima Peninsula was covered with low hanging thick clouds. Therefore, the PIC abandoned the planned route – flight along the western coast of the Oshima Peninsula.
- (2) While flying over the Tsugaru Straits, the PIC decided to advance to a mountainous area in the Oshima Peninsula where parts of the ridges were visible through patches of clouds and then, in order to avoid in-cloud flight, descended below the clouds.
- (3) After advancing to the mountainous area in the Oshima Peninsula, the PIC, maintaining visual contact with the ground adjusting the altitude to avoid the clouds, flew in the direction of fewer clouds avoiding ground contact.
- (4) The PIC tried to continue north-bound flight over the mountainous area; however, low hanging clouds prohibited his visual recognition of mountain features over the wide area. The PIC judged that his attempt would be difficult and he decided to turn to the right to fly over the sea. His trial was done under low visibility conditions without degraded visual recognition of mountain ridges. The belated decision making lead to a flight into a tree

canopy on the mountain ridge.

### **3.6 Aircraft Condition**

The following reasons probably support the theory that the Aircraft had no anomalies before the crash.

- (1) As described in 2.1, at 10:30:07 -- about 10 min. before the crash, the Aircraft reported a normal operation to the New Chitose FSC over Tappizaki at 3,500 ft.
- (2) As described in 2.1, the communication records with the Flight Service Center involved and with the Company radio contained no report of aircraft malfunction.
- (3) The radar track records described in 2.1 indicate the Aircraft's uneventful flight: no in-flight problems.
- (4) The following evidence supports the Aircraft's level flight just before its crash into tree canopies.
  - a. Impact scars left on trees described in 2.11.1.
  - b. Cylindrical dent on the leading edge of main wings perpendicular to wing-span direction, which are believed to be the result of tree impact as described in 2.11.2.(4).

### **3.7 Distress Signal Sent by ELT**

As described in 2.10.2 and 2.13, the SAR helicopter over the accident site received the ELT distress signal around 11:46 on July 30, two days after the crash. As described in 2.11.2 (6), the radio component installed inside of the aft fuselage had no major damage.

These findings indicate the proper function of the ELT and it was activated by the impact of the crash.

The impact of the crash with trees and other objects damaged the antenna at its base and it was most probably emitting weak signal and this explains the reason why the ELT signal were not received until the SAR helicopter came over the accident site.

### **3.8 Selection of Continued VFR Flight under Reduced Visibility Condition for Company Flight**

As described in 2.5 (1), the PIC had a valid instrument flight certificate. Considering the Aircraft operation described by the manager at the Company's Airplane Operation Department in 2.14 (1), the PIC's flight records in 2.14 (2) c and the Company's Operation Service Procedure I described in 2.16, it is probable that the PIC was aware of the option of a flight rule change from VFR to IFR in case he encountered an IMC during the VFR flight considering the onboard equipment and aircraft performance.

As described in 2.14 the manager stated that "Although the Aircraft can fly IFR, it was not assumed for this class of single-engine aircraft to fly IFR by a single pilot on board. The change of flight rules from VMC to IFR under difficult VMC conditions, it was purely an emergency action for the Aircraft with onboard equipment." and "he had a tendency to dodge clouds by lowering the altitude and fly visually confirming the ground under bad weather conditions."

As described in 2.16, the Operation Service Procedure I stipulates that "In principle, no VMC ON TOP flight is authorized" and this requires a flight rule change to IFR for an on-top flight.

As described in 2.6.5 and 2.15, the Aircraft was equipped with necessary equipment for IFR flight; however, it was not equipped with an anti-icing system, a weather radar unit or an autopilot system. A flying under icing meteorological conditions was prohibited.

Although above mentioned equipment is not mandatory for IFR flight, but an anti-icing system should be necessary in case of an icing meteorological condition: in clouds at high-altitudes and at low temperatures. Installing a weather radar system and autopilot system are preferred for avoiding a strong rainy area and reducing the work load of a pilot during an IFR flight.

Above mentioned elements suggest that PIC, considering the equipment and the aircraft performance, chose to fly low below the clouds maintaining visual contact with the ground, without changing the flight rules from VFR to IFR under a low-visibility company flight condition.

### **3.9 Compliance with VMC and Minimum Safe Altitude**

As described in 2.1 and 3.8, at the time of the accident, the Aircraft was probably flying VFR at 300 m or less above the ground.

The VMC in this case falls under 1-3, Article 5 of Ordinance for Enforcement of the Civil Aeronautics Act as described in 2.17: “flight visibility is over than 1,500 meters” and “aircraft may fly away from clouds and that the pilot may visibly recognize the ground surface or the water surface”.

The minimum safe altitude in this case falls under 1-1-b, Article 174 of Ordinance for Enforcement of the Civil Aeronautics Act: “an altitude at which an aircraft can continue flight while maintaining a distance of 150 meters or more from human beings or objects on the ground or on water”.

However, the rugged mountains in the Oshima Peninsula and reduced visibility in the area may have made it difficult to fly complying with the provisions mentioned even if a satisfactory altitude above the ground had been secured before advancing to the area. It is probable that PIC’s loss of continued visual contact with the ground consequently led to the crash into the tree canopy near the ridge.

### **3.10 Preventive Measures**

#### **3.10.1 Pre-flight Confirmation of Meteorological Information by Pilots with Operation Controller Involved**

As described in 3.3.1 (3), the Controller A did not consult with the PIC about meteorological information. As described in 3.3.1 (5), in view of the weather condition, the PIC should not have decided to fly VFR to Sapporo Airfield. Judging from these findings, a pilot needs to confirm meteorological information before the flight in cooperation with an operation controller and the two should discuss for common understanding about the weather.

#### **3.10.2 Operation Monitoring and Operation Support**

The operation control department at the Company’s head office takes care of all flight plans. As described in 2.16, in order to support the operations of air fleet before and during flight, an operation controller collects various flight information and provides it to aircraft concerned. But as described in 2.8.3 and 2.14, it is probable that operation monitoring, collection of en-route meteorological information and forwarding necessary information to the Aircraft was not done when the Aircraft was flying.

As limited radio coverage from the local office causes certain limitation to operation monitoring and supply of meteorological information by the Operation Control Department, the Company should try to provide necessary information to pilots involved.

As described in 2.7.5, the Pilot A who was in the northern part of the Oshima Peninsula

probably had a more concrete picture of the weather in areas around the accident site by comparing the meteorological information obtained from weather forecasts and meteorological observations. Integrating weather information possessed by individual pilot across the country by the department and its dissemination will ensure each pilot to better counter changes of weather.

### **3.10.3 VMC and Minimum Safe Altitude for Company Flight**

When a pilot flies VFR maintaining VMC and visual ground contact under reduced visibility condition, he/ she needs to orient himself/ herself by seeing the geographical features confirming mountain elevations on the flight route, to maintain a minimum flyable safe altitude.

In order to fly through an area where low visibility is expected, a pilot who flies VFR has to check elevations of mountains and other objects in the area in advance.

As described in 3.5.2 (4), the belated decision making to turn back probably lead to a flight into a tree canopy on the mountain ridge. As stipulated in the Operation Service Procedure I in 2.16, when a pilot flying VFR expects to encounter a condition where it is difficult to fly maintaining minimum safe altitudes, he/ she needs to change the flight route while avoiding clouds or change the destination aerodrome without delay.

### **3.10.4 Request for Radar Vector**

As described in 3.8, the PIC was probably aware that when he encountered an expected IMC during the VFR flight, he had an option of changing flight rules from VFR to IFR, considering the onboard equipment and aircraft performance.

However, as described in 2.1, the Aircraft was flying over the Tsugaru Straits as of 10:37:32 and then, it was flying at a low altitude for a period of 2 min. and 20 sec. from its start of descent to the time when its target disappeared from the ATC radar display at 10:39:52. It is probable that the PIC, without changing flight rules from VFR to IFR by climbing, continued to fly VFR at low altitude and without requesting for a radar vector by an ATC facility and the Aircraft consequently crashed into the tree canopy near the ridge.

When a pilot flying VFR expects to encounter a condition where it is difficult to fly maintaining minimum safe altitudes, he should have an option of changing the flight rule to IFR at an appropriate time upon considering the onboard equipment and aircraft performance, and requesting for radar vector by an ATC facility.

### **3.10.5 Safety Education for Pilots**

The Company needs to implement a thorough safety education for its pilots again regarding the following matters:

- (1) A PIC should make the final weather judgment for the airspace he is going to fly in a cautious manner.
- (2) As described in 3.10.3, when a pilot flying VFR expects to encounter a situation where it is difficult to fly maintaining minimum safe altitudes, he/ she needs not to push himself/ herself too hard but to turn back without delay.
- (3) As described in 3.10.4, when a pilot, who has a valid instrument flight certificate flies an aircraft authorized for IFR flight, flies VFR and expects to encounter a situation where it is difficult to fly maintaining minimum safe altitudes, he/ she should have an option of changing the flight rule to IFR at an appropriate time upon considering the onboard equipment and aircraft performance, and requesting for radar vector by an ATC facility.



As described in 2.6.5, for an aircraft without an anti-icing system, and for an aircraft prohibited from flying in an icing meteorological condition as described in 2.15, attention should be paid to avoid airspace where icing conditions are expected.

## 4. CONCLUSIONS

### 4.1 Summary of Analysis

#### (1) Weather

- a. The PIC probably judged before departure that weather in the Hokkaido region would worsen as time goes by.
- b. The PIC's post-departure confirmation of the latest aeronautical weather observations for Sapporo Airfield and Okushiri Airport probably made him think that it would be difficult to fly on the route via the western coast of Hokkaido due to bad weather data at Okushiri Airport whereas the weather at Sapporo Airfield – the destination was good.
- c. The Aircraft was probably able to continue its VFR flight up to the Tsugaru Straits, just in front of the Oshima Peninsula, after taking off from Niigata Airport and flying past the Tohoku region.
- d. Around 10:40, the time when communication with the Aircraft was lost, it is possible that the sea off the southwestern coast of Oshima Peninsula was covered with low hanging clouds, and they were enveloping the ridges in the southwestern part of the Oshima Peninsula.

#### (2) Flight Route

- a. It is highly probable that the Aircraft was flying almost in line with its planned flight route from Niigata Airport to an area over Tappizaki.
- b. However, it is highly probable that the Aircraft deviated from the planned route after that and started descending before reaching the Oshima Peninsula and advanced to the mountainous area in the Oshima Peninsula and while turning to the right east-southeastward, it crashed into a ridge at an elevation of about 750 m (about 2,460 ft).

#### (3) Condition of Aircraft

- a. The Aircraft probably had no mechanical anomalies up to the time of the accident.
- b. The continued distress signal sent by the ELT following the impact with the trees and the other objects demonstrates that its radio component was functioning normal. It is highly probable that the distress signal sent by the ELT was not immediately received because the antenna had been broken near its base at the time of the impact.

#### (4) PIC's Judgment on Advance to Mountainous Area in Oshima Peninsula

- a. The cloud cover over the Oshima Peninsula and low hanging clouds over the sea along the western coast of the peninsula suggests the PIC's decision making to abandon the original course.
- b. Partial recognition of mountains in Oshima Peninsula possibly made him decide to advance there after crossing the Tsugaru Straits.
- c. As the Company's regulation prohibits from flying VMC ON TOP, the PIC probably chose to descend to avoid clouds and to have continued visual contacts with the ground.

(5) Crash after Collision with Trees

Loss of visual contacts with the ground and following failure to maintain minimum safe altitude possibly lead to the Aircraft's crash into the tree canopies on the ridge.

## 4.2 Probable Causes

Loss of visual contacts with the ground and following failure to maintain minimum safe altitude over the mountains in Oshima Peninsula during a VFR flight to Sapporo Airfield probably led to the Aircraft's crash into the tree canopies on the ridge, resulting in a total destruction of the Aircraft and fatal injuries of the PIC and the passenger.

It is probable that the PIC's belated decision to turn back resulted in the loss of visual contact with the ground.

# 5 ACTIONS TAKEN

Measures taken by the Company as preventive actions after the accident are as follows:

## 5.1 Actions Taken for Retraining and Others

The Company implemented the following educational programs and measures for each of the departments concerned:

(1) Aircraft Operation Department

- a. On July 30, 2010, "An alert to the accident during a company ferry flight" was issued as an Operation Department notice. The notice strongly encourages a pilot on a mission to reconfirm the matters listed below to ensure safety during a flight operation. (Summary)
  - (a) In addition to completing matters for pre-flight checks a PIC should pay special attention to confirming thorough meteorological information. PIC's weather judgment should be done cooperatively with the commitment of an operation controller at a local office.
  - (b) When a PIC's lone difficult decision is required, contact the Head Office for weather support. Never resort to an unreasonable operation.
  - (c) Use services such as operation control, FSC etc. to collect the latest weather information for situation analysis.
  - (d) In case of an encounter of abrupt weather change, a PIC should not hesitate to decide to turn back.
  - (e) Considering the onboard equipment and aircraft performance, a PIC should operate the aircraft in a manner which fits its situation.
  - (f) Have a through pre-flight consultation with the customer. Have a clear go-no-go decision criterion to deal with a weather condition which affects the operation involved .
- b. The Company organized reeducation programs and group discussions regarding the operation manual etc. and selected problems that must be addressed from the CRM point of view.

(2) Helicopter Operation Department

On July 30, 2010, "An alert to the accident during a company ferry flight," which is identical with that was described in (1) a., was issued as an Aircraft Operation Department notice.

The department carried out a safety education program which includes studies on accident occurrence factors, operation safety manual and others, and the past accidents which resulted from weather-related reasons.

(3) Operation Control Office

- a. On July 30, 2010, “An alert to the accident during a company ferry flight” was issued as a notice. It stipulates that operation controller should pay attention to the matters listed below and ensure safe operations. (Summary)
  - (a) Operation control includes operation monitoring (grasping an operation progress) and operation support (positive collection and analysis of information necessary for flight and quick dissemination).
  - (b) Operation Controller should perform a pre-flight weather check with a PIC and share understanding about a weather condition which may affect the flight and provide flight assistance to an airborne aircraft.
  - (c) Operation Controller should monitor a flight with company radio and ATC communication, use FSC services and relaying radio message from in-flight Company aircraft.
- b. The Operation Controller held meetings and implemented special training programs about the accident of the Aircraft.

(4) Maintenance Department

The department held special aircraft inspections and ELT function checks.

## 5.2 Taken Improvements

- (1) Safety education programs were provided to all pilots. The Company has decided to standardize a judgment procedure minimizing the individual discretion for operational go-no-go.
  - a. Safety Education for Pilots
    - (a) The Company carried out in-house education programs on the use of FSCs.
    - (b) The Company carried out programs for CRM training by having personnel attend from the Aviation Division\*<sup>8</sup> and the Geo-Survey Division\*<sup>9</sup> while creating an environment in which the participants can present their free opinions about operations and aiming at increasing their awareness about safe operations among company personnel as a whole.
  - b. Support System by Whole Organization for Go-No-Go Decision

Unreasonable operations shall be eliminated by creating an environment in which the flight schedule or customer requests will not directly reach to a PIC. The PIC shall consult with the Director of Operation Department when there are factors which affect safe operations, such as weather-related factors.

The Company has reinforced assistance to a pilot for his preparation of a flight plan by providing operation controller’s assistance.
- (2) The Company revised the matters listed below with regard to the operation support and operation monitoring.
  - a. Operation monitoring has been improved by reviewing the division of jobs for personnel in

---

\*<sup>8</sup> The Aviation Division includes the Airplane Operation Department, the Helicopter Operation Department, the Operation Control Office and the Maintenance Department.

\*<sup>9</sup> The company staff photographer who is the passenger belongs to the Geo-Survey Division.

the Operation Control Office.

b. A chief operation controller has been assigned for proper operation control.

c. Operation monitoring will be strengthened by sharing flight information between the head office and local offices involved.

(3) Matters with regard to other problems to be addressed

a. The Company has accepted a delegate from the Geographical Survey Service Department as a member of its Safe Operation Promotion Committee.

b. In order to ensure safe and effective operations, the Company has designated a person exclusively in charge of aircraft-related jobs who will collect and integrate information from each department and disseminate it to the departments concerned for coordination.

Figure 1 Estimated Flight Route

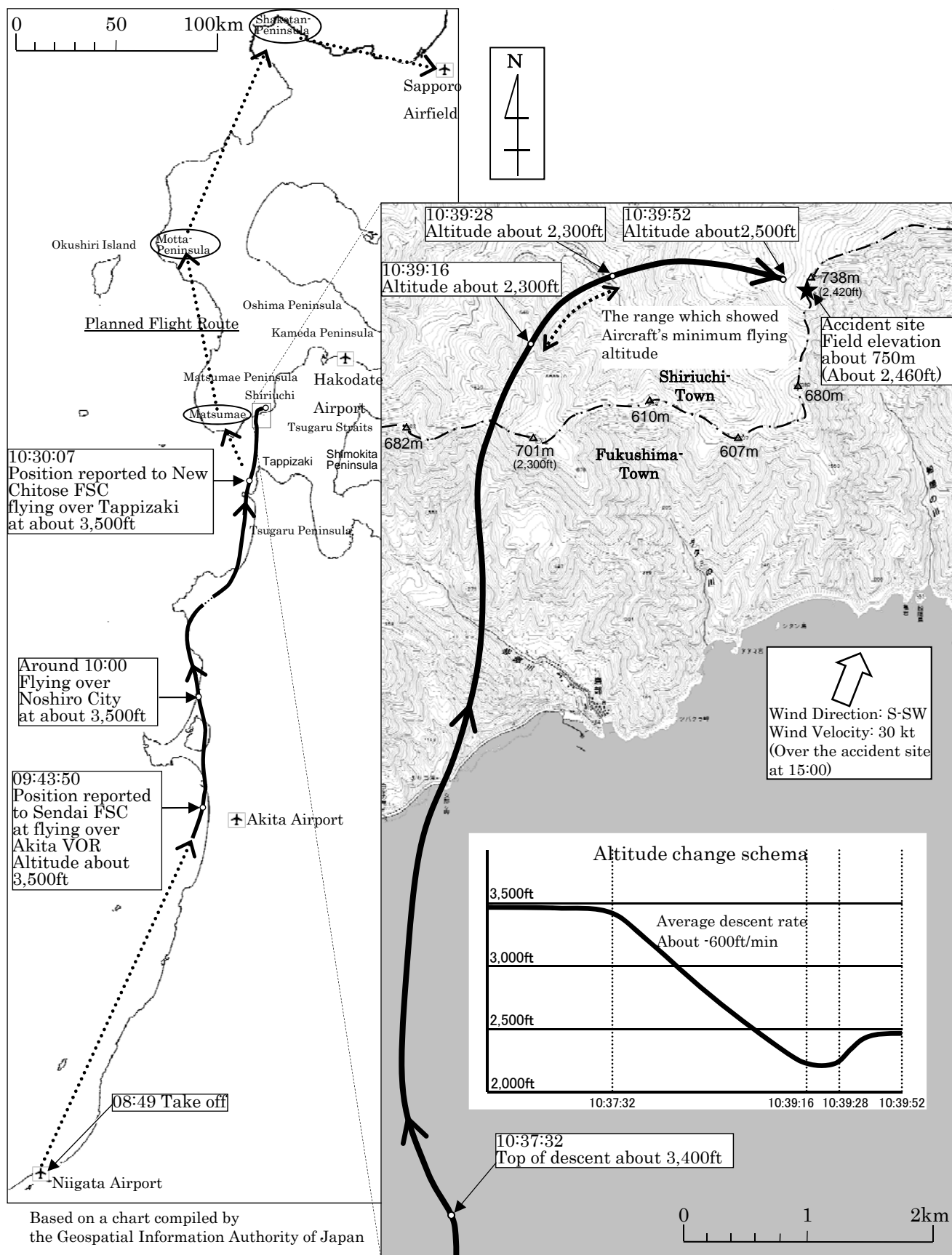

Based on a chart compiled by the Geospatial Information Authority of Japan

Figure 2 Accident Site Layout

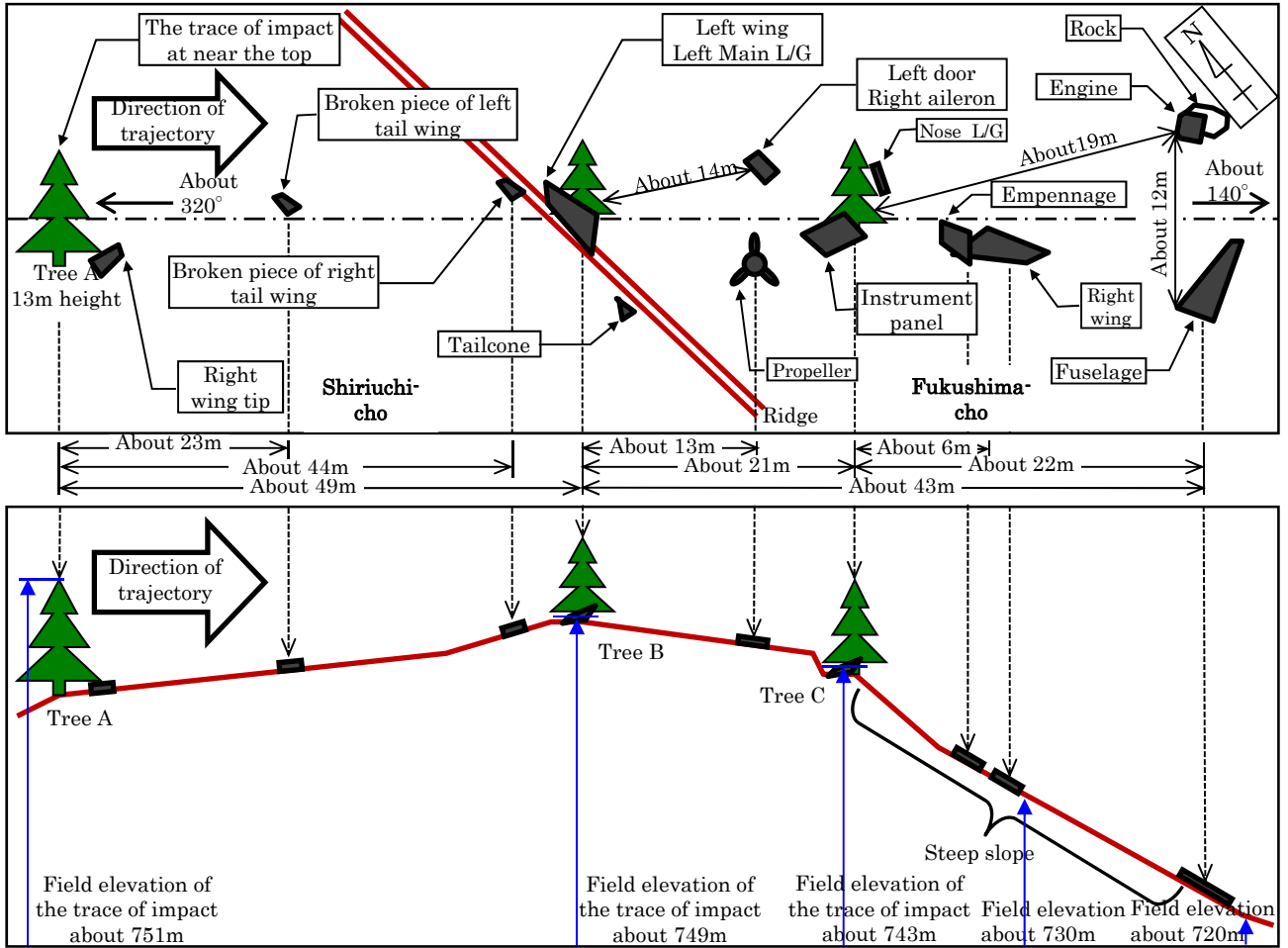

※ The area between tree A and tree B is covered with dense wood.

Accident site

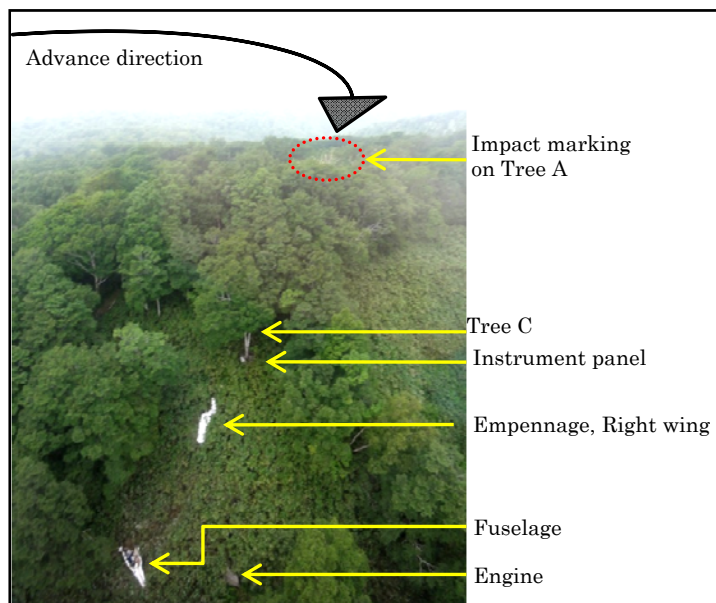

Figure 3 Oshima Peninsula Area Layout

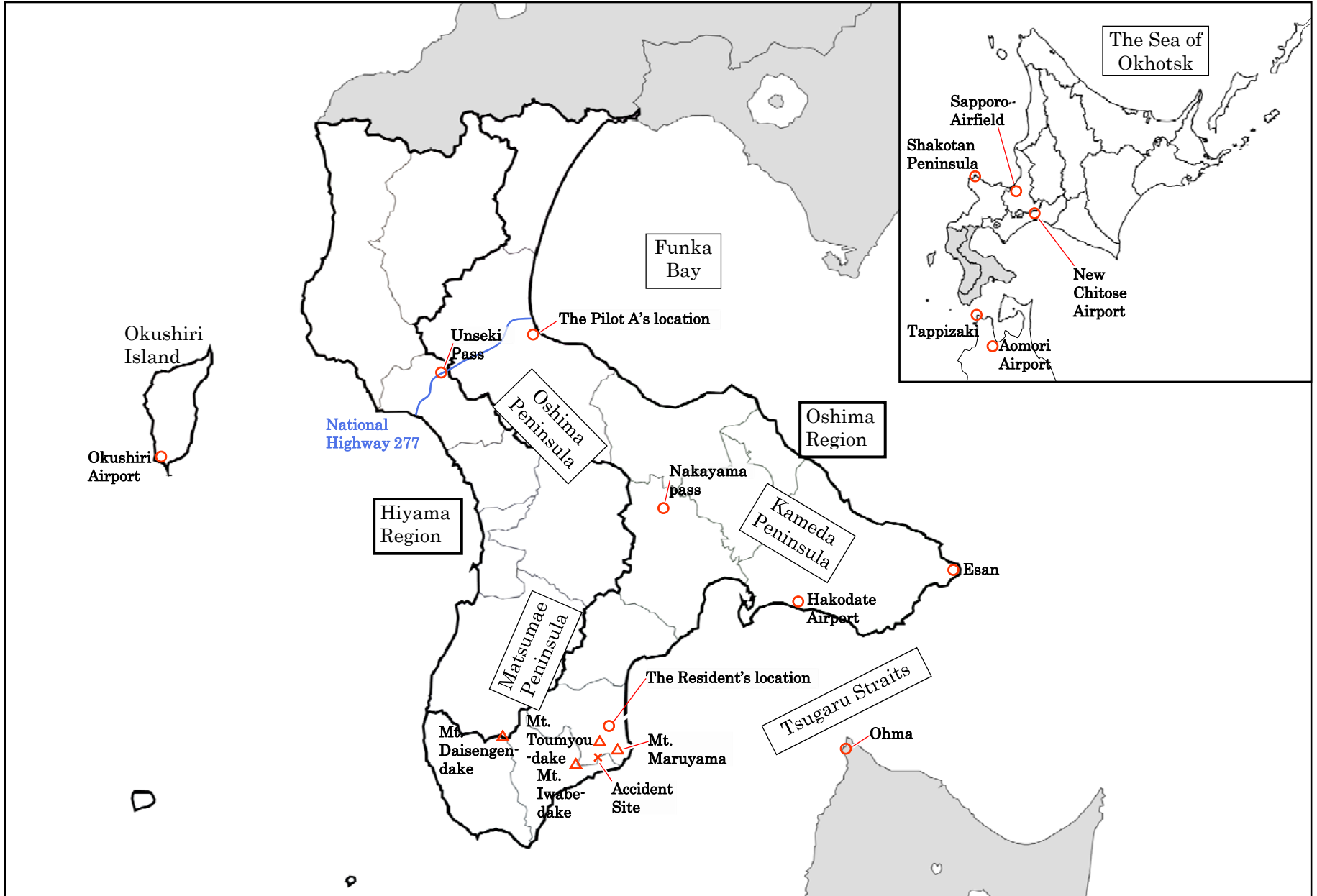

Figure 4 Three Angle View of Cessna TU206G

Unit: m

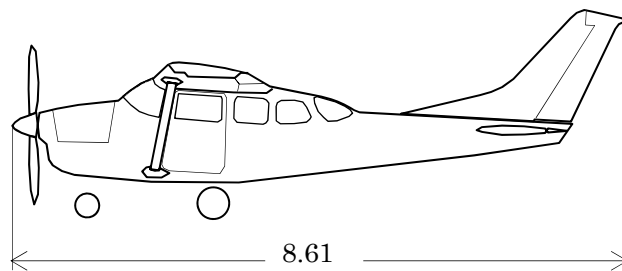
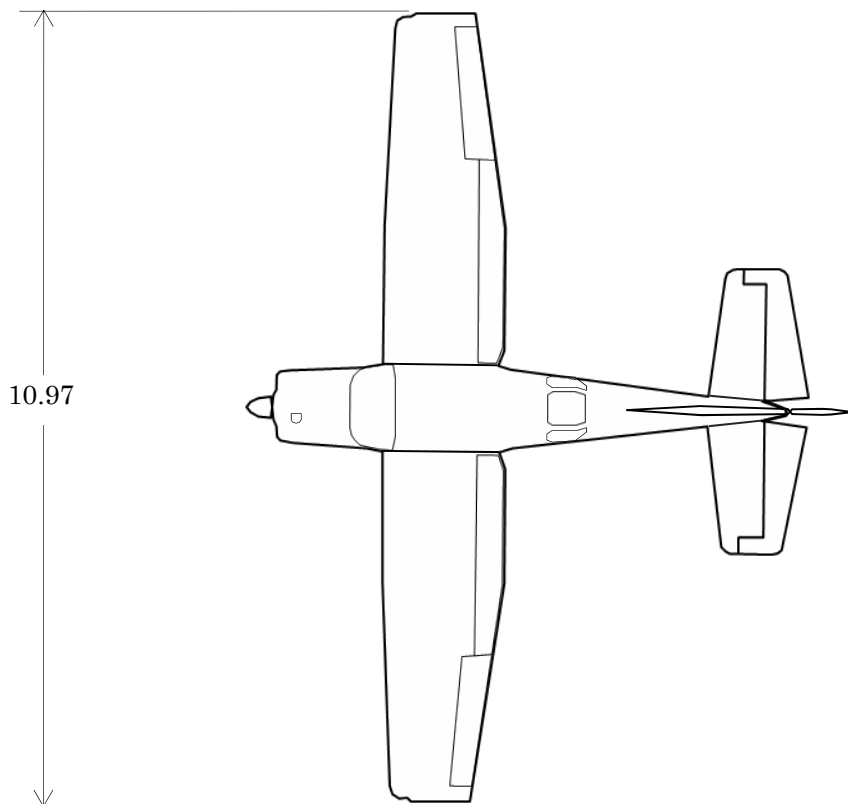
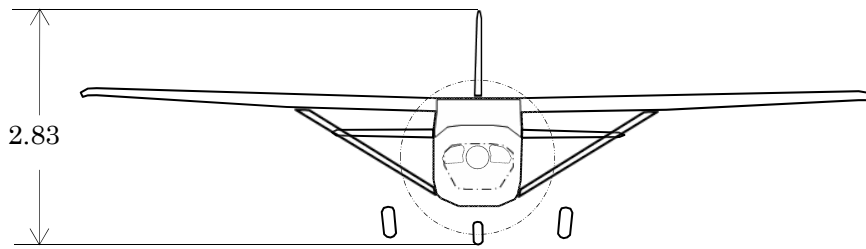



Figure 5 Asia Pacific Surface Analysis Chart (0900JST 28 July)

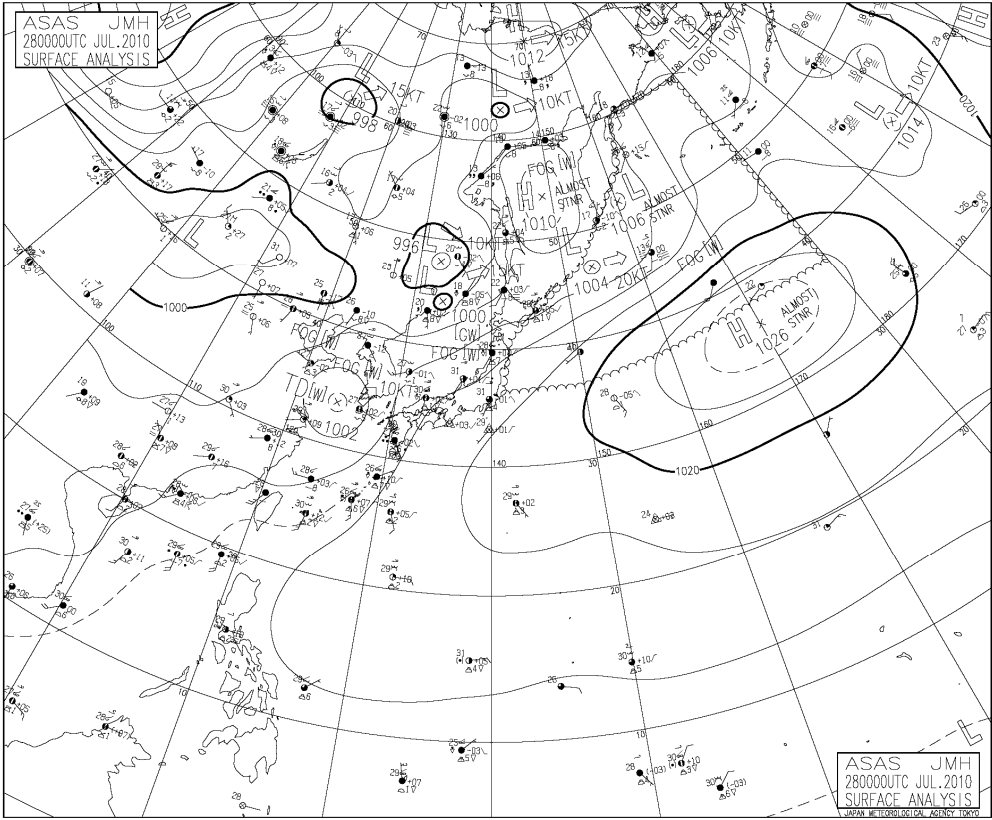

Figure 6 Asia Pacific Surface Analysis Chart (1500JST 28 July)

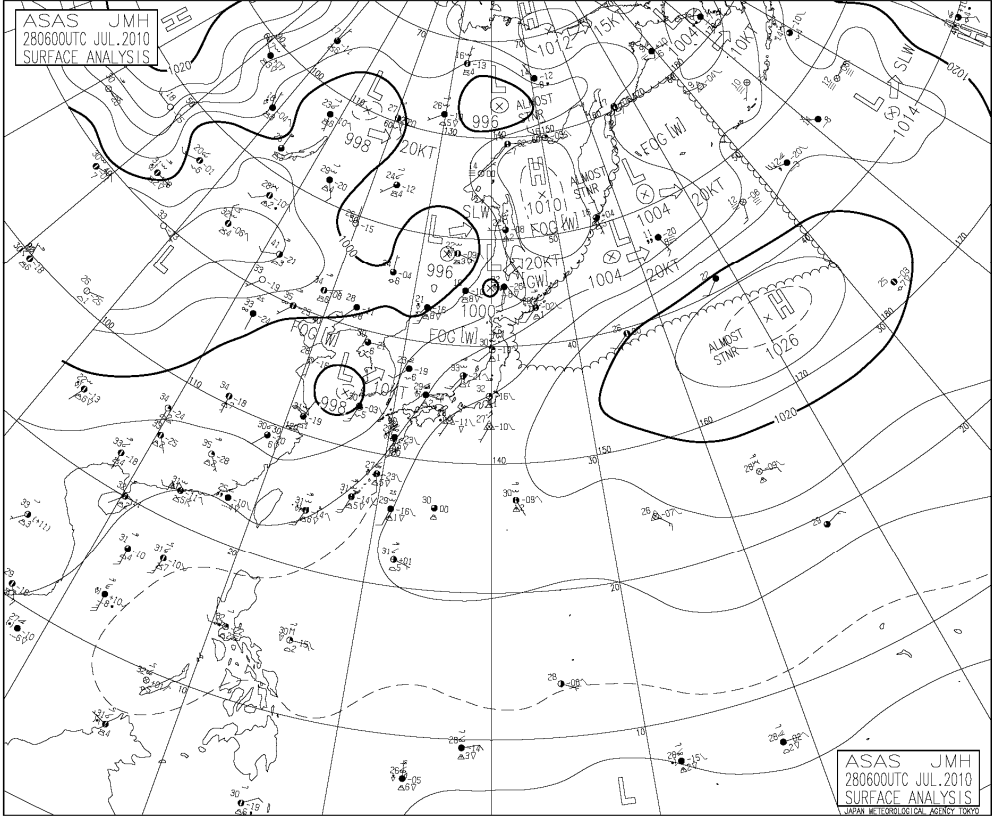

Figure 7 Meteorological Satellite Japan Area Visible Imagery (1030JST 28 July)

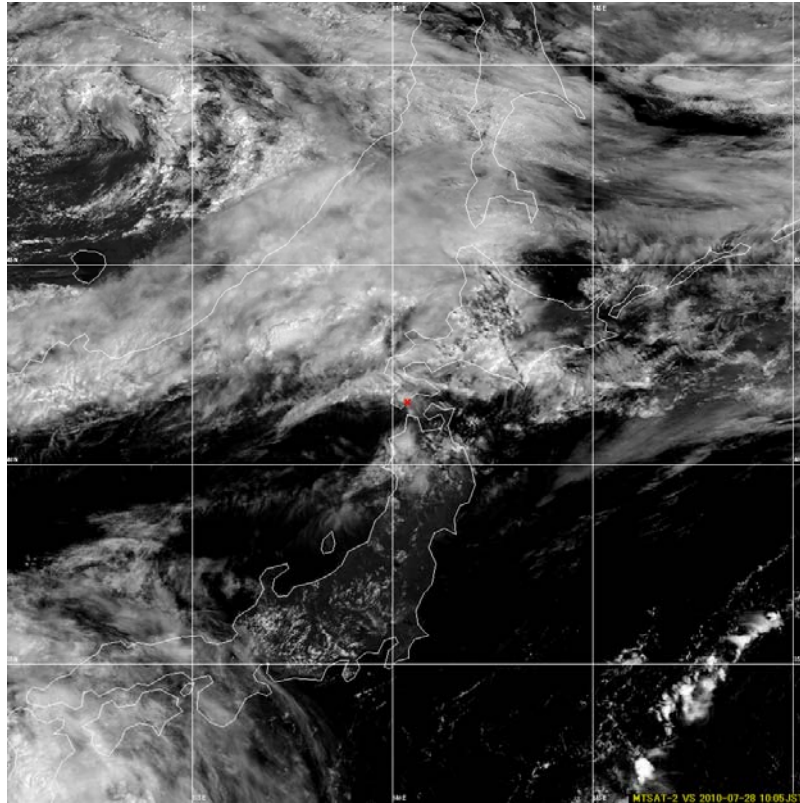

Figure 8 Meteorological Satellite Japan Area Visible Imagery (1500JST 28 July)

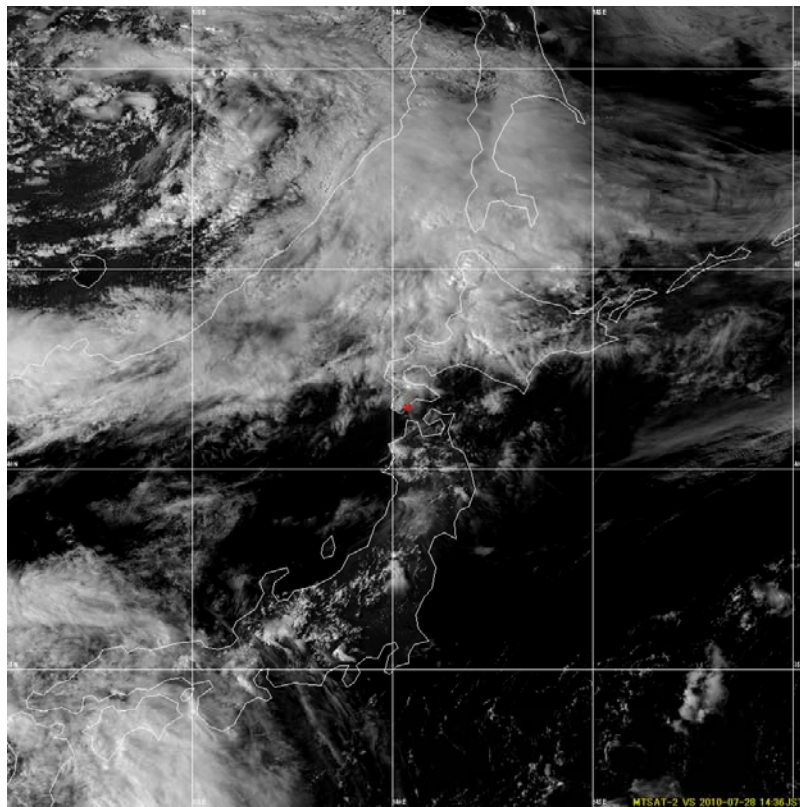

Figure 9 Rader Echo Chart (1040JST 28 July)

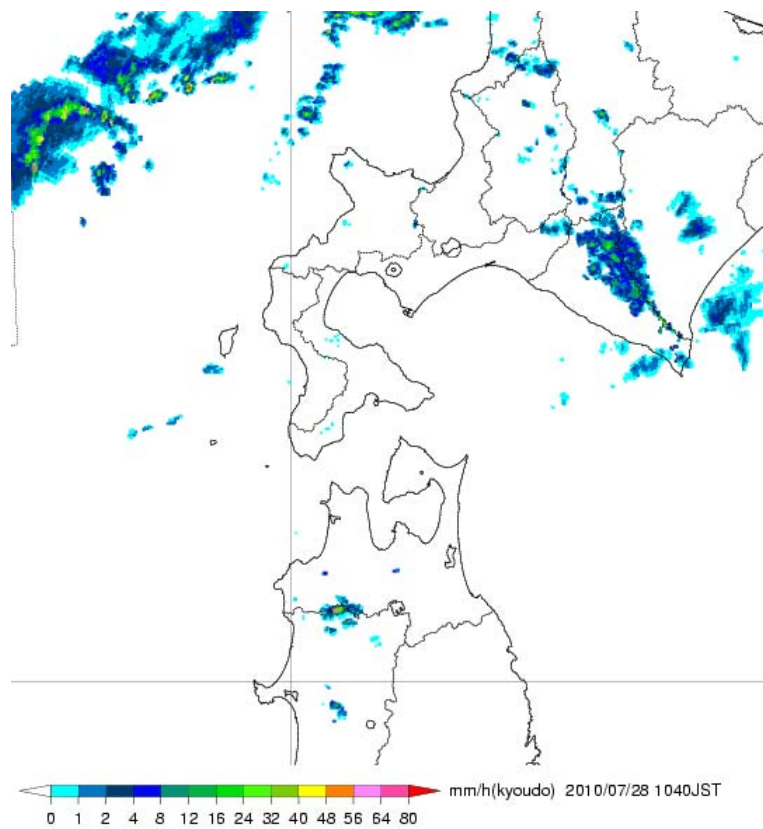
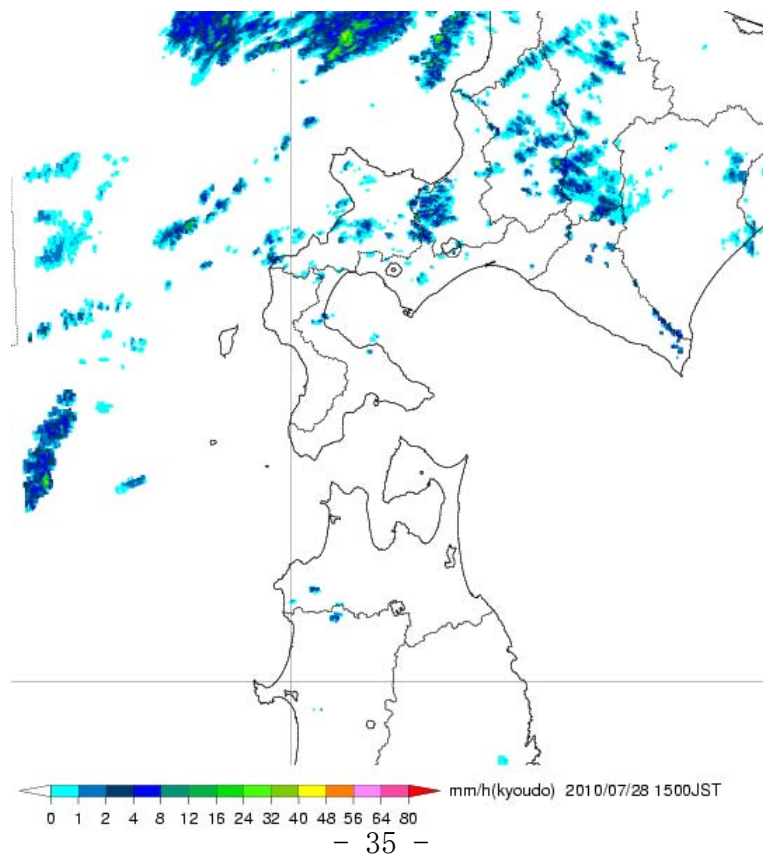

Figure 10 Rader Echo Chart (1500JST 28 July)



# Figure 11 Operation Limitation Decision Table

CESSNA TU206G

Feb 21, 2002

CESSNA TU206G

Feb 21, 2002

## Attachment 4 Operation Limitation Decision Table

(Mandatory Equipment for each Operation Limitation)

Equipment	Minimum Quantity	Operation							
		A	B	C	D	E	F	G	H
Attitude Ind	1 (Note 2)	<input type="radio"/>	<input type="radio"/>						
Directional Gyro	1	<input type="radio"/>	<input type="radio"/>						
Turn and Bank Ind	1 (Note 3)	<input type="radio"/>	<input type="radio"/>						
Slip Ind	1	<input type="radio"/>	<input type="radio"/>						
Altimeter	1 (Note 2)	<input type="radio"/>	<input type="radio"/>						Note 8 <input type="radio"/>
Vertical Speed Ind	1	<input type="radio"/>	<input type="radio"/>						
Airspeed Ind with Anti-Ice Pitot Tube	1 (Note 2)	<input type="radio"/>	<input type="radio"/>						
OAT Ind	1	<input type="radio"/>	<input type="radio"/>	<input type="radio"/>					
Clock with Second hand	1	<input type="radio"/>	<input type="radio"/>	<input type="radio"/>					
DME	1 (Note 4)	<input type="radio"/>	<input type="radio"/>	<input type="radio"/>					
ADF, VOR, TACAN	1 (Note 2)	Note 5 <input type="radio"/>	Note 6 <input type="radio"/>	Note 6 <input type="radio"/>					
Navigation Light						<input type="radio"/>			
Anti-collision Light						Note 7 <input type="radio"/>			
Anti-Iceing System								<input type="radio"/>	
Oxygen System									<input type="radio"/>

Not only equipment listed above, but requirement stipulated in the Ordinance for Enforcement of the Civil Aeronautics Act needs to be complied.

### Operation Limitation

A Flight with IFR

B Instrument flight

C Flight with instrument navigation

(A flight above the clouds or ocean which exceeds distance or time stipulated under Article 66 of Ordinance for Enforcement of the Civil Aeronautics Act on VMC)

D Visual flight other than instrument navigation

E Night flight

F Daytime VFR flight

G Flight on icing conditions (Authorized in type certificate)

H High-altitude flight (over an altitude of 3,000 m)

(Note 1) Oxygen System must provide following quantities.

(1) The aircraft, without cabin pressurizing system

(a) When the aircraft flies at an altitude from 3,000m to 4,000m, it should have the amount of oxygen for all crew and passengers for the period of time flying over 3,000m minus 30 minutes.

(b) When the aircraft flies at an altitude over 4,000m, it should have the amount of oxygen for all crew and passengers for the period of time flying over 4,000m.

(2) The aircraft, which has cabin pressurizing system

For the case where the aircraft flies more than 3,000m, it should have the amount of oxygen for all crew and passengers for the period of descent from the maximum altitude to 3,000m. (For the operation safety, when the aircraft must fly at altitude over 4,000m, the aircraft should have the additional amount of oxygen, for all crew and passengers for the aircraft's flight time concerned.)

(Note 2) The airplane that is used to air transport services with maximum takeoff weight over 5,700kg, must equip 2 systems.

(Note 3) The aircraft that is equipped with attitude gyro indicator, which can indicate any attitude of the aircraft, may not equip this system.

(Note 4) The aircraft may not equip this system, except the aircraft, that is used to air transport services with maximum takeoff weight over 5,700kg (Restrict only the aircraft that must be equipped with VOR receiver system).

(Note 5) Among the ADF, VOR, TACAN, the equipment that receives the radio frequency from the navigation aid that is facilitate along the en-route.

(Note 6) Among the ADF, VOR, TACAN, the equipment that is available to receive the radio frequency from the navigation aid anytime on the flight.

(Note 7) The aircraft whose maximum takeoff weight is above 5,700kg, and also the aircraft whose maximum takeoff weight is below 5,700kg, that is issued airworthiness certificate for the first time after Jan 17, 2003, are mandatory to equip.

(Note 8) Based on the notification of civil aviation bureau, kuu-kou-dai No. 155 (Dec 9, 1971) "The specification of altimeter", it is mandatory in the case at altitude above 16,000ft.

Photo 1 Accident Aircraft (Before Accident)



(Intentionally left blank)

Photo 2 Left Main Wing



Photo 3 Propeller



Photo 4 Instrument Panel



Photo 5 Empennage and Right Main Wing



Photo 6 Fuselage



Photo 7 Engine

