

AIRCRAFT ACCIDENT INVESTIGATION REPORT

China Airlines
Airbus Industrie A300B4-622R, B1816
Nagoya Airport
April 26, 1994

July 19, 1996

Aircraft Accident Investigation Commission
Ministry of Transport

ATTENTION

The English version report has been published and translated by ARAIC to make its reading easier for English speaking people those who are not familiar with Japanese.

Although efforts are made to translate as accurate as possible, only the Japanese version is authentic. If there is difference in meaning of the texts between the Japanese version and the English version, text in the Japanese version are correct.

This report on the accident of China Airlines B1816 has been prepared based upon the investigation carried out by the Aircraft Accident Investigation Commission, in accordance with Annex 13 to the Convention on International Civil Aviation and Article 20 of Aircraft Accident Investigation Commission Establishment Law of Japan.

Kazuyuki Takeuchi
Chairman,
Aircraft Accident Investigation Commission

Abbreviations used in this report are as follows:

AD	: Airworthiness Directive
ADC	: Air Data Computer
AFS	: Automatic Flight System
ALT	: Altitude
ALT SEL	: Altitude Selector
AOA	: Angle of Attack
AP	: Auto-Pilot
APU	: Auxiliary Power Unit
A/THR	: Automatic Thrust
AT	: AutoThrottle
ATS	: Auto-Throttle System
ATT	: Attitude
BEA	: Bureau Enquetes Accidents
BKN	: Broken
CAP	: Captain
CAS	: Computed Airspeed
CGCC	: Center of Gravity Control Computer
CAT	: Category
CMD	: Command
CN	: Consigne de Navigabilite
CVR	: Cockpit Voice Recorder
CWS	: Control Wheel Steering
CFDR	: Digital Flight Data Recorder
DGAC	: Direction Genrale de l' Aviation Civile
ECAM	: Electronic Centralized Aircraft Monitoring
EFCU	: Electronic Flight Control Unit
EFIS	: Electronic Flight Instrument System
ENG	: Engine
EPR	: Engine Pressure Ratio
FAA	: Federal Aviation Administration
FAC	: Flight Augmentation Computer
FADEC	: Full Authority Digital Electronic Control
FCC	: Flight Control Computer
FCOM	: Flight Crew Operating Manual
FCU	: Flight Control Unit
FD	: Flight Director
FIDC	: Fault Isolation and Detection Computer
FIDS	: Fault Isolation and Detection System
FL	: Flight Level
FMA	: Flight Mode Annunciator
FMC	: Flight Management Computer
FMS	: Flight Management System
F/O	: First Officer
FMC	: Flight Warning Computer

GCU	: Generator Control Unit
GPWC	: Ground Proximity Warning Computer
GPWS	: Ground Proximity Warning System
GS	: Glide Slope
HDG	: Heading
HDG/SEL	: Heading Selector
HPC	: High Pressure Compressor
HPT	: High Pressure Turbine
ICAO	: International Civil Aviation Organization
IGS	: Instrument Guidance System
IGV	: Inlet Guide Vane
IND	: Indicator
ILS	: Instrument Landing System
IRS	: Inertial Reference System
IRU	: Inertial Reference Unit
LAND	: Landing
L/D	: Landing
L/G	: Landing Gear
LOC	: Localizer
LPC	: Low Pressure Compressor
LPT	: Low Pressure Turbine
LVL/CH	: Level Change
MAC	: Mean Aerodynamic Chord
MAN THR	: Manual Thrust
MIC	: Microphone
MTP	: Maintenance and Test Panel
NAV	: Navigation
NTSB	: National Transportation Safety Board
OVC	: Overcast
PCM	: Pulse Code Modulation
PF	: Pilot Flying
PFD	: Primary Flight Display
PIC	: Pilot in Command
PNF	: Pilot Not Flying
QNH	: Pressure Setting to Indicate Elevation above Mean Sea Level
R.ALT.	: Radio Altitude
RET	: Retract
RMI	: Radio Magnetic Indicator
RWY	: Runway
SB	: Service Bulletin
SCT	: Scattered
SGU	: Symbol Generator Unit
SPD	: Speed
SPD/MACH	: Speed/Mach
SRS	: Speed Reference System
SW	: Switch
TCC	: Thrust Control Computer
TCD	: Ministry of Transport Civil Aviation Bureau Directive
THR	: Thrust

THR L	: Thrust Latch
THS	: Trimmable Horizontal Stabilizer
TIPS	: Technical Instruction Processing Sheet
TRP	: Thrust Rating Panel
VAPP	: Approach Target Speed
VOR	: VHF Omnidirectional Radio Range
V/S	: Vertical Speed
Vs	: Stall Speed
VTG	: Target Speed
W.STA	: Wing Station

CONTENTS

1	PROGRESS AND PROCESS OF THE AIRCRAFT ACCIDENT INVESTIGATION	1-1
1.1	Summary of the Aircraft Accident	1-1
1.2	Outline of the Aircraft Accident Investigation	1-1
1.2.1	Organization for Investigation	1-1
1.2.2	Implementation of Investigation	1-2
1.2.3	Hearings from the Persons Relevant to the Cause of the Accident	1-2
1.2.4	Public Hearing	1-2
1.2.5	Reporting and Publication	1-3
2	FACTUAL INFORMATION	2-1
2.1	Flight History	2-1
2.2	Injuries to Persons	2-3
2.3	Damage to Aircraft	2-3
2.3.1	Extent of Damage	2-3
2.3.2	Damage to Aircraft by Part	2-3
2.3.3	Distribution of Wreckage, etc.	2-12
2.4	Damage to Other than the Aircraft	2-13
2.5	Crew Information	2-13
2.5.1	Flight Crew	2-13
2.5.2	Cabin Attendants	2-14
2.6	Aircraft Information	2-16
2.6.1	Aircraft	2-16
2.6.2	Engines	2-16
2.6.3	Weight and Center of Gravity	2-16
2.6.4	Fuel and Lubricating Oil	2-16
2.7	Meteorological Information	2-17
2.7.1	Synoptic Weather	2-17
2.7.2	Aeronautical Meteorological Observation and Reports	2-17
2.8	Navigational Aids	2-18
2.9	Communications	2-18
2.10	Airport and Ground Facility Information	2-18
2.11	Information on DFDR and CVR	2-19
2.12	Medical Information	2-19
2.12.1	Autopsies of CAP, F/O and Purser	2-19
2.12.2	Injuries to Survivors	2-21
2.12.3	Damage to Bodies	2-21
2.13	Fire and Fire Fighting	2-21
2.13.1	Fire Fighting and Rescue System at Nagoya Airport	2-21
2.13.2	Fire Fighting Activities	2-22
2.14	Information on Search, Rescue and Evacuation relevant to Survival, Death or Injury	2-24
2.14.1	Information on Search and Rescue Activities	2-24
2.15	Tests and Research to Find Facts	2-27
2.15.1	Investigation of Traces Left on the Ground	2-27
2.15.2	Indication of Major Instruments and Positions of Switches and Levers	2-28
2.15.3	Disassembly Inspection of Engines	2-28

2.15.4	Investigation of FADECs	2-29
2.15.5	Investigation of Computer Memories	2-29
2.15.6	Information on Seating Positions of CAP and F/O	2-30
2.16	Other Necessary Information	2-32
2.16.1	Flight Experience of CAP and F/O	2-32
2.16.2	Qualification Requirements for CAP and F/O, and Promotion System	2-32
2.16.3	Automatic Flight System (AFS)	2-34
3	ANALYSIS	3-1
3.1	Analysis	3-1
3.1.1	Establishments of the times recorded on CVR and DFDR	3-1
3.1.2	Flight of the Aircraft.....	3-1
3.1.3	Estimation of Crash time	3-18
3.1.4	Attitude of Aircraft at the time of Crash and Damage to Aircraft	3-18
3.1.5	Investigation of Engines and FADEC	3-21
3.1.6	Results of Investigation of Computers and Other Equipment	3-22
3.1.7	Seated Positions of CAP and F/O	3-23
3.1.8	Injury to Passengers and Seat Assignment	3-24
3.1.9	Detection of Ethanol in Remains of CAP and F/O	3-25
3.1.10	China Airlines' Operation and Training Rules and Handling of Service Bulletins	3-27
3.1.11	Automatic Flight System	3-32
3.1.12	Fire Fighting and Rescue	3-38
3.2	Summary of Analysis	3-42
3.2.1	General	3-42
3.2.2	Flight Sequence of the Aircraft	3-42
3.2.3	Control and Operation by the Crew	3-43
3.2.4	Crash and Destruction of Aircraft	3-44
3.2.5	Investigation of Ethanol	3-44
3.2.6	Operations and Training of China Airlines and Handling of Service Bulletins	3-44
3.2.7	Automatic Flight System	3-45
3.2.8	Fire Fighting and Rescue System	3-46
4	CAUSES	4-1
5	REFERENCES.....	5-1
5.1	Measures taken after the Accident	5-1
5.1.1	Taiwanese civil aviation authorities.....	5-1
5.1.2	China Airlines	5-1
5.1.3	Bureau Enquetes Accidents (BEA), Direction Generale de l'Aviation Civile (DGAC), France.....	5-1
5.1.4	Airbus Industrie	5-2
5.1.5	Civil Aviation Bureau, Ministry of Transport of Japan	5-2
5.1.6	National Transportation Safety Board (NTSB) and Federal Aviation Administration (FAA) , U.S.A.	5-3
6	SAFETY RECOMMENDATIONS	6-1
7	PROPOSALS	7-1

Figures

Figure 1	Planned Flight Route	A 1
Figure 2	Estimated Flight Route	A 2
Figure 3	ILS Approach Chart (Nagoya ILS RWY 34)	A 3
Figure 4	Approximate Flight Track	A 4
Figure 5	Enlarged Flight Track	A 5
Figure 6	Surface Chart (ASAS) At 15:00, April 26, 1994	A 6
Figure 7	Surface Chart (ASAS) At 21:00, April 26, 1994	A 7
Figure 8	Drawing of Nagoya Airport	A 8
Figure 9	Sketch of Wreckages on the Ground after the Crash	A 9
Figure 10	Enlarged Sketch of Wreckage on the Ground	A10
Figure 11	Main Wreckage of the Accident Aircraft	A11
Figure 12	Traces of Fire	A12
Figure 13	State of Damage to Fuselage Skin.....	A13
Figure 14	Airbus Industrie A300B4-622R Three Views	A14
Figure 15	Control Wing Section	A15
Figure 16	Fuselage Stations-1	A16
Figure 17	Fuselage Stations-2	A17
Figure 18	Fuselage Stations-3	A18
Figure 19	Wing Stations	A19
Figure 20	Engine Sectional View	A20
Figure 21	Engine External View	A21
Figure 22	Controls, Displays, and Indicators in Cockpit	A22
Figure 23	Layout of Lighting Switches in Cockpit	A24
Figure 24	External View of Pilot's Seat	A25
Figure 25	Set Positions of Captain's and First Officer's Seats	A26
Figure 26	Seat Arrangement Chart	A27
Figure 27	Sketch of SLATS/FLAPS Control Lever Gate and Balk	A28
Figure 28	Operation of THS	A29
Figure 29	Assumed FMA Displays	A30

Photographs

Photograph 1	Site Where the Accident Occurred	A31
Photograph 2	Site Where the Accident Occurred and Its Vicinity	A32
Photograph 3	Whole Scene of the Crash Site	A33
Photograph 4	Rescue Activities	A34
Photograph 5	Left Aileron	A35
Photograph 6	Right Aileron	A35
Photograph 7	Right No.6 Spoiler and Left No.7 Spoiler	A36
Photograph 8	Vertical Stabilizer and Rudder	A36
Photograph 9	Left Elevator	A37
Photograph 10	Right Elevator	A37
Photograph 11	THS	A38
Photograph 12	THS Screw Jack	A38
Photograph 13	Left Center Flap	A39
Photograph 14	Left Flap's NO.3 Screw Jack	A39
Photograph 15	Right Flap's NO.2 Track	A40
Photograph 16	Right Center Flap	A40
Photograph 17	Left Outer Slat	A41

Photograph 18	Right Outer Slat	A41
Photograph 19	Left ,Wing	A42
Photograph 20	Fractures of the Right Wing	A42
Photograph 21	Shock Absorber of the Left Main Landing Gear	A43
Photograph 22	Tire and Brake Assembly of the Left Main Landing Gear	A43
Photograph 23	Shock Strut of the Right Main Landing Gear	A44
Photograph 24	Tires of the Right Main Landing Gear	A44
Photograph 25	Leg Assembly of the Nose Landing Gear	A45
Photograph 26	Tires of the Nose Landing Gear	A45
Photograph 27	Front Windows and Upper Surface of the Cockpit	A46
Photograph 28	Part of Outside Surface of the R1 Door	A46
Photograph 29	Surface of Front Fuselage	A47
Photograph 30	Burnt Fuselage Surface	A47
Photograph 31	NO.1 Engine	A48
Photograph 32	NO.1 Engine FADEC	A48
Photograph 33	NO.2 Engine	A49
Photograph 34	NO.2 Engine Pylon	A49
Photograph 35	Center Pedestal 1	A50
Photograph 36	Center Pedestal 2	A50
Photograph 37	Thrust Lever and Go Lever	A51
Photograph 38	SLATS/FLAPS Lever	A51
Photograph 39	THS Manual Trim Wheel	A52
Photograph 40	L/G Lever	A52
Photograph 41	Outward Appearance of Display Unit with Broken Indicators	A53
Photograph 42	Captain and Center Light Panel	A53
Photograph 43	DFDR	A54
Photograph 44	CVR	A54
Photograph 45	CAP's Seat	A55
Photograph 46	F/O's Seat	A55
Photograph 47	Passenger Seats (for Business Class)	A56
Photograph 48	Passenger Seats (for Economy Class)	A56
Photograph 49	Impact Mark of the Left Main Gear on the Ground	A57
Photograph 50	Impact Mark of the Right Main Gear on the Ground	A57
Photograph 51	GO Lever Alignment with Thrust Lever	A58

Appendix

Appendix 1	Outline of automatic flight system	A59
Appendix 2	An Extract from A300-600 FCOM	A69
Appendix 3	Examples of the previous incidents and Measures taken after the Incidents.....	A77
Appendix 4	Changes to AFSs on A300-600	A87
Appendix 5	Airport Service Manual (Extract)	A88
Appendix 6	DFDR Records	A92
Appendix 7	CVR Records	A113

8	Comments from France and Taiwan, and the Notice from the USA	8 - 1
	Comments from France	8 - 2
	Comments from Taiwan	8 - 24
	Notice from the USA	8 - 50

AIRCRAFT ACCIDENT INVESTIGATION REPORT

**China Airlines
Airbus Industrie A300B4-622R, B1816
Nagoya Airport
APRIL 26, 1994**

July 15, 1996

**Decision by the Aircraft Accident Investigation
Commission**

Chairman	Kazuyuki Takeuchi
Member	Tetsuichi Kobayashi
Member	Tsutomu Kawai
Member	Minoru Higashiguchi
Member	Yasuhiko Aihara

1. PROGRESS AND PROCESS OF THE AIRCRAFT ACCIDENT INVESTIGATION

1.1 Summary of the Aircraft Accident

China Airlines Airbus Industrie A300B4-622R B1816 took off from Taipei International Airport at 0853 UTC (1753 JST) on April 26, 1994 and continued flying according to its flight plan. About 1116 UTC (2016 JST), while approaching Nagoya Airport for landing, the aircraft crashed into the landing zone close to E1 taxiway of the airport.

On board the aircraft were 271 persons: 256 passengers (including 2 infants) and 15 crew members, of whom 264 persons (249 passengers including 2 infants and 15 crew members) were killed and 7 passengers were seriously injured. The aircraft ignited, and was destroyed.

1.2 Outline of the Aircraft Accident Investigation

1.2.1 Organization for Investigation

1.2.1.1 On April 26, 1994, the Aircraft Accident Investigation Commission assigned an investigator-in-charge and nine investigators.

1.2.1.2 The following nine technical advisors were appointed for the investigation of specialized matters with regard to the accident (titles are as of the date of appointment):

(1) For analysis of damage to the airframe structure and related matters

Shojiro Kaji, Professor, Department Aeronautics and Astronautics, Faculty of Engineering, the University of Tokyo

Tetsuhiko Ueda, Head, Flight Load Laboratory, Airframe Division, National Aerospace Laboratory, Science and Technology Agency

Makoto Sasaki, Head, Engine Performance Laboratory, Aeroengine Division, National Aerospace Laboratory, Science and Technology Agency

Keiji Tanaka, Head, Human Engineering Laboratory, Control Systems Division, National Aerospace Laboratory, Science and Technology Agency

Kouhei Funabiki, Human Engineering Laboratory, Control Systems Division, National Aerospace Laboratory, Science and Technology Agency

(2) For analysis of flight performance

Nagakatsu Kawahata, Professor, Dept. of Science and Engineering, Nihon University
Shigeru Saito, Head, Flight Test Laboratory, Flight Research Division, National Aerospace Laboratory, Science and Technology Agency

(3) For analysis of operations

Atsushi Toriya, Captain, Japan Air Lines Co.,Ltd.(retired)

Shigeyuki Yagura, Commander, Aeromedical Laboratory Unit, Air Self-Defense Force (retired)

1.2.1.3 For specialized studies, a Structural Investigation Group, a Flight Performance Investigation Group and an Operations Investigation Group were established.

- 1.2.1.4 Upon occurrence of the accident, chairman, members, investigator-in-charge and investigators, etc. were dispatched to the crash site, and at the same time, an investigation team was set up on site. The team remained on site until may 20 to continue their investigations.
- 1.2.1.5 During the fact-finding investigation, cooperation was given by a number of related organizations and personnel including Police Agency, Defense Agency, Science and Technology Agency, Meteorological Agency, and local governments and fire squadrons of Aichi Prefecture and so on.
- 1.2.1.6 Accredited Representatives from France as the state of aircraft manufacture, the U.S.A as the state of engine manufacture, and Taiwan as the operations authority, participated in the factual investigation.

1.2.2 Implementation of Investigation

April 26 - May 20, 1994	On-site investigation
April 27 - May 1, 1994	Interview with eye witnesses
April 27 - September 27, 1994	Interview with aircraft passengers
April 27, 1994 - November 29, 1995	DFDR retrieval
April 27, 1994 - November 29, 1995	CVR transcripts
September 4 - September 9, 1994	Visit to Taiwan by investigators and a technical advisor
September 28, 1994 - January 27, 1995	Disassembly Investigation of engines
November 6 - December 4, 1994	Visit to U.S.A. by investigators and technical advisors
November 14 - November 28, 1994	Visit to France by a commission member, investigators and technical advisors
January 6 - February 28, 1995	Investigation of the equipment by disassembly, etc.
January 6 - February 28, 1995	Investigation of reconstructed airframe
January 17 - March 24, 1995	Investigation of flight performance

1.2.3 Hearings from Persons Relevant to the Cause of the Accident

Hearings were hold.

1.2.4 Public Hearing

The AAIC published a draft of Factual Investigation Report on January 9, 1995, and held a public hearing on February 7 to hear the accounts of 12 persons (either directly connected with the incident or who had knowledge and experience relevant to the investigation, etc.).

- (1) Date: 10:30 - 16:30 February 7, 1995
- (2) Place: Assembly Hall, 10th Floor, Ministry of Transport

- (3) Hearing chairman: Tohru Toyoshima, Director-General, Secretariat of AAIC
- (4) Witnesses (in order of speech):
Dr. Jiro Kouo, Witness asked by AAIC. Doctor of Mechanical Engineering, Professor, Tokai University
Capt. Taketoshi Udo, Witness asked by AAIC. Captain, President, Japan Airline Pilots Association
Mr. Ange Ortega, Witness asked by AAIC. Deputy to Senior Vice President, Airbus Industrie.
Mr. Kuang-Feng Chang, Speaker asked by AAIC. Vice President-Operation, China Airlines.
Mr. Wataru Habuka, Company Executive.
Mr. Noriyasu Shirai, Company Employee.
Mr. Takao Kawakita, Chairman, Organizing Committee, International Rally of Endeavors to Improve Air Safety.
Capt. Ryohei Yabuno, President, Airline Pilot Association of Japan, Captain, Japan Air Lines.
Mr. Kazuya Chikamura, Deputy President, Flight Crew Union's Federation of Japan, Flight Engineer, Japan Airlines.
Mr. Shujiro Okuno, Chairman, Federation of Aviation Worker's Union, Captain, Japan Air System.
Mr. Tsung-Li Kow, Doctor of Medicine, Professor, Postgraduate Medical School, Taiwan University.
Mr. Norman D. Hull, Partner of Accident Investigation and Research Inc.
- (5) Summary of Statements
Omitted (See the stenographic transcriptions of the hearing.)

1.2.5 Reporting and Publication

The progress of the investigation, including principal facts which came to light through the factual investigation, was reported to Minister of Transport and published on May 10, 1994 and January 9, 1995.

2. FACTUAL INFORMATION

2.1 Flight History

China Airlines' Flight 140 (from Taipei International Airport to Nagoya Airport), B1816, took off from Taipei International Airport at 0853 UTC (1753 JST) on April 26, 1994 (hereinafter all times shown are Coordinated Universal Time, unless otherwise specified), carrying a total of 271 persons consisting of 2 flight crew members, 13 cabin crew members and 256 passengers (including 2 infants).

The flight plan of the aircraft, which had been filed to the Taiwanese civil aviation authorities, Zhongzheng International Airport Office, was as follows:

Flight rule: IFR, Aerodome of departure: Taipei International Airport, Destination Aerodome: Nagoya Airport, Cruising speed: 465 knots, Level: FL 330, Route: A1 SUC-JAKAL-KE-SIV-XMC, total estimated enroute time: 2 hours and 18 minutes, Alternate Aerodome: Tokyo International Airport.

DFDR shows that the aircraft reached FL 330 about 0914 and continued its course toward Nagoya Airport in accordance with its flight plan.

DFDR and CVR show that its flight history during approximately 30 minutes prior to the accident progressed as follows:

The aircraft which was controlled by the F/O, while cruising at FL 330 was cleared at 1047:35 to descend to FL 210 by the Tokyo Area Control Center and commenced descent.

For about 25 minutes from a few minutes before the aircraft began its descent, the CAP briefed the F/O on approach and landing.

At 1058:18, communication was established with Nagoya Approach Control. The aircraft began to descend and decreased its speed gradually, in accordance with the clearances given by Approach Control.

At 1104:03, the aircraft was instructed by Nagoya Approach control to make a left turn to a heading of 010°. Later, at 1107:14, the aircraft was cleared for ILS approach to Runway 34 and was instructed to contact Nagoya Tower.

After the aircraft took off from Taipei International Airport, from 0854 when the aircraft had passed 1,000 ft pressure altitude, AP No.2 was engaged during climb, cruise and descent. At 1107:22, when the aircraft was in the initial phase of approach to Nagoya airport, AP No.1 was also engaged. Later, at 1111:36, both AP No.1 and 2 were disengaged by the F/O.

The aircraft passed the outer marker at 1112:19, and at 1113:39, received landing clearance

from Nagoya Tower. At this time, the aircraft was reported of winds 290 degrees at 6 knots.

Under manual control, the aircraft continued normal ILS approach.

At 1114:05, however, while crossing approximately 1,070 ft pressure altitude, the F/O inadvertently triggered the GO lever. As a result the aircraft shifted into GO AROUND mode leading to an increase in thrust.

The CAP cautioned the F/O that he had triggered the GO lever and instructed him, saying "disengage it". The aircraft leveled off for about 15 seconds at approximately 1,040 ft pressure altitude (at a point some 5.5 km from the Runway).

The CAP instructed the F/O to correct the descent path which had become too high. The F/O acknowledged this. Following the instruction, the F/O applied nose down elevator input to adjust its descent path, and consequently the aircraft gradually regained its normal glide path.

During this period, the CAP cautioned to the F/O twice that the aircraft was in GO AROUND Mode.

At 1114:18, both AP No.2 and No.1 were engaged almost simultaneously when the aircraft was flying at approximately 1,040 ft pressure altitude, a point 1.2 dots above the glide slope. Both APs were used for the next 30 seconds. There is no definite record in the CVR of either the crew expressing their intention or calling out to use the AP. For approximately 18 seconds after the AP was engaged, the THS gradually moved from -5.3° to -12.3° , which is close to the maximum nose-up limit. The THS remained at -12.3° until 1115:11. During this period, the elevator was continually moved in the nose-down direction.

In this condition, the aircraft continued its approach, and at 1115:02, when it was passing about 510 ft pressure altitude (at a point approximately 1.8 km from the runway), the CAP, who had been informed by the F/O that the THR had been latched, told the F/O that he would take over the controls. Around this time, the THR levers had moved forward greatly, increasing EPR from about 1.0 to more than 1.5. Immediately afterwards, however, the THR levers were retarded, decreasing EPR to 1.3. In addition, the elevator was moved close to its nose-down limit when the CAP took the controls.

At 1115:11, immediately after the CAP called out "Go lever", the THR levers were moved forward greatly once again, increasing EPR to more than 1.6. The aircraft therefore began to climb steeply. The F/O reported to Nagoya Tower that the aircraft would go around, and Nagoya Tower acknowledged this. The aircraft started climbing steeply, AOA increased sharply and CAS decreased rapidly. During this period, the THS decreased from -12.3° to -7.4° , and SLATS/FLAPS were retracted from 30/40 to 15/15 after the F/O reported "Go Around" to Nagoya Tower.

At 1115:17, the GPWS activated Mode 5 warning "Glide Slope" once, and at 1115:25, the stall warning sounded for approximately 2 seconds.

At 1115:31, after reaching about 1,730 ft pressure altitude (about 1,790 ft radio altitude), the aircraft lowered its nose and began to dive.

At 1115:37, the GPWS activated Mode 2 warning "Terrain, Terrain" once, and the stall

warning sounded from 1115:40 to the time of crash.

At about 1115:45, the aircraft crashed into the landing zone close to the E1 taxiway.

The accident occurred within the landing zone approximately 110 meters east-northeast of the center of the Runway 34 end at Nagoya Airport. It occurred at about 1115:45 (2015:45 JST) (see attached Figures 1,2,3,4,5 and Photographs 1, 2 and 3).

2.2 Injuries to Persons

	Crew	Passengers	Others
Fatal	15	249	-
Serious	-	7	-
Minor/None	-	-	-

2.3 Damage to aircraft

2.3.1 Extent of damage

The aircraft was destroyed.

2.3.2 Damage to Aircraft by Part

(1) Flight control system

① Aileron

Both the RH and LH ailerons were in their down positions and were burnt.
(See attached Photographs 5 and 6)

② Spoilers

- The No. 1 and No. 2 LH spoilers were missing.
- All the LH roll spoilers (No. 3 through No. 7) were almost completely destroyed by fire.
- The No. 3 and No. 7 LH actuators were found in their stowed positions, while the No.4 through No. 6 actuators were in their extended positions.
- The No. 1, No. 2, and No. 5 RH spoilers had fallen away and were burnt.
- The No. 3 and No. 4 RH spoilers remained attached to the wing, while the No. 6 and No. 7 spoilers had torn off together with their adjacent wing structural elements.
- All the RH actuators were in their stowed positions.

(See attached Photograph 7)

③ Rudder

- The rudder was burnt and remained attached to the vertical stabilizer.

(See attached Photograph 8)

④ Elevators

- The elevators remained attached to the THS, but were damaged.
- Both the RH and LH elevators had scratches on their leading edge lower surfaces, but none on the trailing edge lower surface.

(See attached Photographs 9,10)

⑤ THS

- The THS had separated at its joint to the fuselage, and was fractured at its central section.
- The screw jack was fractured and had torn off at the screw shaft section near the actuator's bottom end; it was bent near the nut.

(See attached Photographs 11 and 12)

⑥ Flaps

- The LH inner flap was fractured at the outside of the No. 2 track beam and burnt; no other LH flap parts were found.
- The LH No. 1 and No. 2 track beams had been ripped off, and were fractured and burnt.
- The LH center flap had torn off from the wing together with the No. 3 and No. 4 track beams and was burnt.
- The LH outer flap was burnt and had separated from the wing with the No. 5 and No.6 track beams attached on it.
- The RH inner flap had separated from both the wing and track beams and was fractured and burnt.
- The RH No. 1 and No. 2 track beams had torn off, and the No. 1 beam was burnt.
- The RH center flap had separated from the wing with the No. 3 and No. 4 track beams attached to it and was burnt.
- The RH outer flap had separated from the wing, and was burnt and fractured on the inboard side of the No. 6 track beam.
- The RH No. 5 track beam had torn off and was burnt.

(See attached Photographs 13,14 ,15 and 16)

⑦ Slats

- The LH inner slat was fractured at the outboard track attaching point, with its outboard section separated from the wing.
- The LH center slat was burnt, remained attached to the wing.
- The LH outer slat was fractured in three places and separated from the wing; scratches were found on its leading edge.
- The RH inner slat had separated from the wing with two track rails attached to it.
- The RH center slat was fractured at the No. 3 screw jack attaching point; its outboard section was burnt and had separated from the wing with a track rail attached on it.
- The RH outer slat was fractured at two points, had separated from the wing, and was burnt.

(See attached Photographs 17 and 18)

- ⑧ Kruger flaps
 - Both the RH and LH Kruger flaps were in their extended positions.

- ⑨ Notch flaps
 - Both the RH and LH notch flaps were in their extended positions.

(2) Wings

- ① LH wing
 - The main spar and upper skin in the upper section of the pylon (between W.STA 400 and 485) were fractured.
 - The skin in the rear part of the aft main spar, on the inboard side of the aileron, was destroyed by fire.
 - The lower skin had been exposed to flames and was burnt.
 - The upper skin between W.STA 940/RIB 13 and W.STA 1567/ RIB 23 had melted.
 - The wing tip was fractured near W.STA 1567/RIB 23, and had separated from the main wing and burnt.
 - The tip fence was fractured and burnt, and had separated with its lower part deformed. (See attached Photograph 19)

- ② RH wing
 - Almost all portions of the leading edge located on the inboard side of the No. 2 engine pylon were destroyed by fire.
 - The skin in the rear part of the aft main spar, inboard the aileron, was partly destroyed by fire.
 - The upper skin and the aft main spar near W.STA 879/RIB 12 were cracked.
 - The RH wing was fractured and had torn off near W.STA 1132/ RIB 16; the detached wing outboard structure had fragmented into small pieces, some of which were burnt.
 - The wing tip was fractured, had torn off near W.STA 1624/RIB 24, and was burnt.
 - Tip fence was fractured and had torn off with its top deformed. (See attached Photograph 20)

- ③ Center box section
 - The center box section was burnt.
 - Almost all thrust work ribs of the center-box lower structure had buckled and fractured by an upward force (see attached Figure 19).

(3) LH main landing gear

- The upper section of the shock strut was fractured, and had broken off and burnt.
- Fractured drag strut and torque link remained attached to the lower section of the shock strut.
- The shock strut was fractured; its upper section was partly burnt and had been detached with the actuating cylinder, fractured drag strut and other parts still attached to it.

- The wing side rear mount was fractured and remained attached to the aft hinge point in the upper section of the shock strut.
- The shock absorber had been displaced from the shock strut and was detached.
- The shock absorber contained pieces of the fractured bogey beam and torque link still attached to it.
- The shock absorber's piston was detached from the cylinder.
- The lower strut of the folding brace was fractured and detached.
- The lock link assembly was fractured and detached, with the cylinder and the strut of the folding brace (fractured) still attached to it.
- Both of the two cross braces had separated and burnt.
- The bogey beam was fractured at both its front and rear sections, with the outer brake assemblies (No. 1 and No. 5 assemblies) of both sections detached from their axles. Tires and wheels were also detached.
- No.6 brake assembly, as well as corresponding tire and pieces of bogey beam, etc, were found at a point about 190 meters away from where the LH main landing gear had hit the ground.
- No. 1 and No. 5 tires were burnt.
(See attached Photographs 21 and 22)

(4) RH main landing gear

- The shock strut was partly burnt and detached, with parts including the actuating cylinder and fractured drag strut, etc, still attached to its upper section.
- The drag strut, torque link, and part of the folding brace strut, all fractured, remained attached to the lower section of the shock strut.
- The shock strut rear mount, fractured and detached from the wing, remained attached to the aft hinge point in the upper section of the shock strut.
- The shock absorber had been displaced from the shock strut and was detached.
- The shock absorber had the fractured bogey beam and pieces of torque link still attached to it.
- The shock absorber's piston had torn off.
- The folding brace had a fractured lower strut, and was burnt and detached with a part of airframe structural element still attached to it.
- Both cross braces had separated and were burnt.
- The lock link was fractured and found at a point about 170 meters away from where the RH main landing gear had hit the ground.
- The bogey beam was fractured at both its front and rear sections. The No. 3 and No. 4 brake assemblies of the front section had come off their axles, and the tires and wheels were detached and destroyed.
- The No. 7 and No. 8 brakes, as well as the corresponding tires and wheels (two each) were burnt in an assembled state.
- The No. 3 and No. 4 tires had burst, and the No. 4 tires were burnt.
(See attached Photographs 23 and 24)

(5) Nose landing gear

- The shock strut was fractured at its upper and lower sections.
- The upper section of the barrel had fragmented into small pieces.
- The telescopic drag strut was found bent in the down-lock state and was burnt.
- The lower part of the torque link was fractured.
- Both tires and wheels were in place on the axle and were found in the irrigation water channel. The axle was bent and the LH tire had burst. (See attached Photographs 25 and 26)

(6) Fuselage

① Nose section

- The entire nose section had fragmented into small pieces, except the ceiling section above the front windshield, which barely retained its original form.

② Forward section

- The bottom skin was fractured at a location between Stringers 38 and 42. It was found near where the aircraft had hit the ground together with the bottom skin of the aft fuselage. The skin above that section was fractured at locations corresponding to Frames 18, 26, and 40.

③ Center section

- The bottom skin was fractured at a location between Stringers 38 and 42, but remained connected to the bottom skin of the aft fuselage.
- Almost the entire center section of the fuselage was destroyed by fire except a portion of the side skin.

④ Aft section

- The aft fuselage section was almost entirely destroyed by fire except a part of the RH side skin.

⑤ Tail

- The tail was fractured at locations corresponding to Frames 72 and 92 with the vertical stabilizer attached to it. It was partly burnt and was found in the irrigation water channel.
- The upper joints of the tail section had separated. The APU compartment was damaged at its bottom with the APU still inside, and was found partly overlapping the THS.
- The bottom skin was fractured at a location corresponding to Frame 78, and was found together with fragments of the other bottom skin near where the aircraft had hit the ground. (See attached Figures 16, 17, 18 and Photographs 27, 28, 29 and 30.)

(7) No. 1 engine

- ① Low-pressure compressor
 - The fan case was detached from the intermediate case and was deformed.
 - The nose cone had fallen away.
 - The fan blades were torn or bent in the direction opposite to that of rotation. Among the blades torn, only one was fractured at its root.
 - The No. 1.6, 2, and 3 stage LPC blades were torn or bent in the direction opposite to that of rotation.
 - Approximately one third of No. 4 stage LPC blades were bent in the direction opposite to that of rotation, and the rest were torn off.
 - The No. 1, 2 and 3 stage LPC stators had fallen away or were bent in the direction of rotation.
 - All but a few of the No. 4 stage LPC stators had fallen away or were deformed.
 - All the fan exit guide vanes had fallen away.
 - Approximately three-fifths of the LPC rotor was cracked at the No. 3 and No. 4 stage labyrinth seal locations. Within the cracked area, approximately one third of the total circumference had been pressed inward; the No. 4 stage disk was detached and had fallen away.
 - The LPC-LPT coupling was fractured and found inside the fan hub.
 - The inner race of the No. 1.5 bearing remained attached to the LPC-LPT coupling, but all the rollers had fallen away.

- ② Intermediate case
 - The No. 1 bearing rear support had torn off at the flange that had connected it to the No. 1 bearing front support.
 - The struts were broken.

- ③ High pressure compressor
 - The HPC front case had torn off from the rear case at the intervening joint and remained attached to the intermediate case.
 - All the No. 5, 6, 7, and 8 stage HPC blades had fallen away.
 - All the HPC stator vanes on the IGV, except about 20 of them, were broken.
 - The No. 5, 6, and 7 stage HPC stator vanes were broken or deformed.
 - The unison rings on the IGV, No. 5 stage, and No. 6 stage stators were deformed, and the lower half of the ring on the No. 7 stage stator had torn off.
 - The HPC rear case was detached from the HPC front case at the intervening joint, and remained attached to the diffuser case.

- ④ Diffuser case and combustor
 - Borescopic inspection of the interior of the combustor did not reveal any abnormalities.
 - Borescopic inspection of the No. 1 stage turbine nozzles did not reveal any abnormalities.

- ⑤ High-pressure turbine
 - The tips of the No. 1 stage turbine blades had broken off.
 - The No. 2 stage turbine nozzle blades had slightly chipped off at their trailing edges.
 - All the No. 2 stage turbine blades had broken and fallen away.
 - The No. 2 stage turbine disk had deep scratches running in the direction of rotation on its rear section.
 - The HPT case was detached from the LPT case at the flange section.

- ⑥ Low-pressure turbine
 - All the No. 3, 4, 5, and 6 stage turbine blades had fallen away.
 - All the No. 3, 4, 5, and 6 stage turbine vanes had fallen away.
 - The forward end of the LPT case was detached from the HPT case at the connecting flange section, and its rear end was detached from the turbine exhaust case at a section near the connecting flange. The case had separated, and was severely cracked and deformed.
 - The No. 6 stage LPT disk was detached from the No. 5 LPT disk at the intervening joint, and the No. 6 stage disk was broken and detached.
 - The labyrinth seal in the forward section of the LPT had been pushed rearward by a strong force, and was in close contact with the No. 3 stage LPT disk.
 - The LPT shaft was broken in its front section.
 - The LPT rotor was out of its original position toward the rear.

- ⑦ Exhaust case
 - The exhaust case remained attached to the pylon, and many of its struts were fractured. The case was significantly deformed.
 - The inner race of the No. 4 bearing remained attached to the LPT shaft, and 3 cm of its track was partially lost; but the track surface displayed no other abnormalities. The outer race and the roller cage sections were filled with mud, and no rollers were found. (See attached Figures 20, 21 and Photograph 31.)

(8) No. 2 engine

- ① Low-pressure compressor
 - The fan case was almost completely detached from the intermediate case and was significantly deformed.
 - The nose cone had fallen away.
 - The fan blades either had torn off or were bent in the direction opposite to that of rotation.
 - The fan hub had separated from the LPT rotor at the intervening joint.
 - The No. 1, 2 and 3 stage LPC blades either had torn off or were bent in the direction opposite to that of rotation.
 - All the No. 4 stage LPC blades had fallen away.
 - Some No. 1, 2 and 3 stage LPC stator vanes had fallen away and all the remaining

vanes were bent in the direction of rotation.

- The No. 4 stator vanes between the 10 and 2.5 o'clock positions remained attached but the other vanes had broken off.
- All the fan exit guide vanes had fallen away.
- The LPC rotor was separated at the rear of the labyrinth seal located between the No. 3 and 4 stage disks, and the No. 4 stage disk had fallen away.
- The LPC-LPT coupling was fractured at its front section and had fallen away. A remnant of the broken LPT shaft was found attached inside the coupling.
- The outer race of the No. 1 bearing was partially broken as wide as 18 balls, but remaining ball-bearings displayed no abnormalities.
- The inner race of No. 1.5 bearing remained attached to the LPC - LPT coupling, but the rollers had fallen away. The track surface of the inner race displayed no abnormalities.
- There was a through crack running in the axial direction at the 3 o'clock position.
- The leading edges of the No. 5 stage HPC blades were damaged.
- All the HPC stators vanes of the IGV had fallen away.
- Borescopic inspection revealed that molten metal had adhered to the trailing edge of the No. 15 stage stator.

② Intermediate case

- The No. 1 bearing rear support had separated from the No. 1 bearing front support at the mounting flange section, and its rear end had separated at the section in front of the flange that had connected it to the intermediate case. The rear support had fallen away.
- The strut at the 10 o'clock-position remained extended almost straight as far as the outer contour of the case, but the strut at the 8 o'clock position was bent. All other struts were fractured at their root sections.

③ High-pressure compressor

- The bolts on the upper half of the joint between the HPC front case and the HPC rear case were broken, and there was an about three-centimeter wide gap in the upper half of the joint. There was a through crack running in the axial direction at the 3 o'clock position.
- The leading edges of the No.5 stage HPC blades were damaged.
- All the HPC stators vanes of the IGV had fallen away.
- Borescopic inspection revealed that molten metal had adhered to the trailing edge of the No.15 stage stator.

④ Diffuser case and combustor

- The bottom of the diffuser case was dented.
- Borescopic inspection of the interior of the combustor did not reveal any particular abnormalities.
- Borescopic inspection of the No. 1 stage turbine nozzles revealed no particular abnormalities.

⑤ High-pressure turbine

- The trailing edges of the No. 1 turbine blades were slightly chipped off.

- The No. 2 stage turbine nozzles in the section between the 10 o'clock and 12 o'clock positions were damaged in their rear portions.
- All the No. 2 stage turbine blades were broken and had fallen away.
- The No. 2 stage turbine disk had deep scratches all over its rear section, running in the direction of rotation.
- The HPT case was detached from the LPT case at the connecting flange section.

⑥ Low-pressure turbine

- All the No. 3, 4, 5 and 6 stage turbine blades had fallen away.
- All the No. 3, 4, 5 and 6 stage turbine vanes had fallen away.
- The forward section of the LPT case had separated from the HPT case at their connecting flanges, and its rear section was detached from the turbine exhaust case in the vicinity of their connecting flanges. The case had fallen away and was severely cracked and deformed.
- The No. 6 stage LPT disk was detached from the No. 5 stage disk at the intervening joint, and the disk itself was cracked.
- The labyrinth seal in the forward section of the LPT had been strongly pushed rearward and was in close contact with the No. 3 stage LPT disk.
- The LPT shaft was broken in its forward section.
- The LPT rotor had come off rearward, together with the LPT shaft, and had fallen away.

⑦ Exhaust case

- The exhaust case remained attached to the pylon. The case had through cracks running in axial directions at the 1 o'clock, 3 o'clock, and 11 o'clock positions. It was deformed extensively.
- The inner race of the No. 4 bearing was lost, preventing its track surface malfunctions from being determined. The bearing's outer race and rollers remained in the exhaust case and the rollers showed no abnormalities. (See attached Figures 20, 21 and Photographs 33 and 34.)

(9) Cockpit

- Almost all the instruments and instrument panels were broken.
- Both RH and LH control column were broken.
- The center pedestal panel was damaged and detached.
- The circuit-breaker panel was broken and many circuit breakers had been thrown out.
- Almost all the components of the flight control system, electric and electronic systems, and their accessories were broken.
- The LH(Captain) and the RH(F/O) crew seats were broken.
(See attached Photographs 35,36,37,38,39,40,41,42,45 and 46)

(10) Cargo-related

- The forward cargo compartment had been loaded with three containers and four palettes,

and the rear compartment with nine containers. The bulk cargo compartment had contained 39 corrugated cardboard boxes in bulk.

- All of the recovered containers were found so extensively destroyed that they no longer retained their original forms. As to the palettes, only their floorboards retained their original forms.

(11) Others

- The DFDR and CVR were separated from the airframe, together with some of their mounting parts. Their outer cases, deformed and partly covered with soot, were discovered near the THS.
- Most of the recovered electronic components were damaged and deformed. Some components were damaged too severely to identify what they were. Their inside printed-circuit boards had fragmented, and the internal wiring of major devices, including computers, were also found broken.
- Relatively heavy accessories were torn from the airframe and strewn about.
- The legs of almost all the cabin seats were fractured. (See attached Photographs 43,44,47 and 48.)

2.3.3 Distribution of Wreckage, etc.

Before the investigation started, some pieces of wreckage had been moved from their original positions in order to facilitate rescue activities. At the time of investigation, the wreckage was scattered as follows:

Due to the impact of the crash, the wreckage of the aircraft except the RH and LH wings, the vertical and horizontal tail planes, the tail section of the fuselage, and the engines, was scattered over an approximately 140 meters long and 60 meters wide area to the east-northeast of the LH main landing gear's ground scar. Fragments of the destroyed skin of the nose and forward fuselage sections were strewn over an approximately 40 meters long and 30 meters wide area, some 120 meters away from the LH main landing gear's ground scar to the east-northeast direction. No signs of damage by fire were found on the nose and forward sections of the fuselage. The lower skin of the fuselage center and aft sections, almost entirely fragmented, were scattered over an approximately 40 meters wide area that extended approximately 60 meters to the east-northeast from the LH main landing gear's ground scar. Other parts of the center and aft fuselage sections except a part of the skin, were almost entirely ruined by fire. The wings ripped from the fuselage, were found at a point approximately 80 meters to the east-northeast of the LH main gear's ground scar. The LH outer wing was torn from the wing, and the RH outer wing, broken into several fragments, was also separated from the wing. They were burnt and discovered near the wings and the water gate, respectively. The LH engine was torn from the wing pylon and was found near the wing, while the RH engine remained barely attached to its pylon. The fan hubs of both engines were broken and detached.

The horizontal tail plane and tail cone were broken and torn from the fuselage, and were

found at a point approximately 30 meters to the east-northeast of the LH main landing gear's ground scar. The vertical tail plane was broken and separated from the fuselage together with the upper rear part of the fuselage. It was burnt and found over the irrigation water channel approximately 65 meters to east-northeast of the LH main landing gear's ground scar.

An approximately 50 meters long and 20 meters wide scorch mark of fire were detected on the ground, each extending to the east-northeast from the vicinities of the ground scars of the LH and RH wing flap tracks, and the trees near the water gate were burnt. Signs of fire were also detected on the ground near where the wings were found (see attached Figures 11 ,12 and Photographs 2 and 3).

2.4 Damage to Other than the Aircraft

A stretch of the lawn under cultivation in the landing zone was burnt and flowed off within an approximately 10,300 m² area.

The protection wall of the irrigation water channel at Komaki Air Base of the Air Self-Defense Force (hereinafter referred to as "Komaki Air Base") was destroyed over a length of 30 meters, and the water gate was damaged.

Of the trees in the soundproofing tree fence in the Komaki Air Base, those within an approximately 2,000 m² area were burnt.

2.5 Crew Information

2.5.1 Flight Crew

Captain: Male, aged 42	
Airline transport pilot license	No 
Type rating	
Airbus A300-600R	Issued July 31, 1992
Term of validity	Until July 30, 1994
Class 1 airman medical certificate	Issued November 2, 1993
Term of validity	Until May 31, 1994
Total flight time	8,340 h 19 min
Total hours on A300 - 600R	1,350 h 27 min
Flight time during the last 90 days	217 h 56 min
Flight time during the last 30 days	71 h 11 min
Latest training on emergency procedures	September 15, 1993
Rest period prior to the flight	15 h 30 min
Note: The captain joined the company on February 1, 1989	

Copilot: Male, aged 26

Commercial pilot license	No. 30701 Issued September 5, 1992
Type rating	
Airbus A300-600R	Issued December 29, 1992
Term of validity	Until December 28, 1994
Class 1 airman medical certificate	Issued March 1, 1994
Term of validity	Until September 30, 1994
Total flight time	1,624 h 11 min
Total hours on A300-600R	1,033 h 59 min
Flight time during the last 90 days	196 h 30 min
Flight time during the last 30 days	71 h 53 min
Latest training on emergency procedures	September 14, 1993
Rest period prior to the flight	39 h 00 min

Note: The copilot joined the company on April 16, 1990

2.5.2 Cabin Attendants

- A. Flight attendant/Manager (female, aged 54)**
- | | |
|---|---------------------------|
| Qualification as attendant | Issued September 14, 1970 |
| Total flight time | 12,225 h |
| Latest training on emergency procedures | June 10, 1993 |
| Rest period prior to the flight | More than 18 h |
- B. Flight attendant/Purser (male, aged 44)**
- | | |
|---|---------------------|
| Qualification as attendant | Issued July 1, 1976 |
| Total flight time | 15,050 h |
| Latest training on emergency procedures | June 22, 1993 |
| Rest period prior to the flight | More than 18 h |
- C. Flight attendant (male, aged 40)**
- | | |
|---|---------------------|
| Qualification as attendant | Issued June 1, 1985 |
| Total flight time | 6,891 h |
| Latest training on emergency procedures | June 8, 1993 |
| Rest period prior to the flight | More than 18 h |
- D. Flight attendant (female, aged 29)**
- | | |
|---|-----------------------|
| Qualification as attendant | Issued April 24, 1987 |
| Total flight time | 5,048 h |
| Latest training on emergency procedures | June 29, 1993 |
| Rest period prior to the flight | More than 18 h |
- E. Flight attendant (female, aged 32)**
- | | |
|----------------------------|----------------------|
| Qualification as attendant | Issued June 30, 1988 |
| Total flight time | 4,205 h |

Latest training on emergency procedures	June 29, 1993
Rest period prior to the flight	More than 18 h
F. Flight attendant (female, aged 28)	
Qualification as attendant	Issued May 18, 1989
Total flight time	3,545 h
Latest training on emergency procedures	July 19, 1993
Rest period to the flight	More than 18 h
G. Flight attendant (female, aged 24)	
Qualification as attendant	Issued September 5, 1989
Total flight time	3,306 h
Latest training on emergency procedures	July 5, 1993
Rest period prior to the flight	More than 18 h
H. Flight attendant (female, aged 27)	
Qualification as attendant	Issued September 5, 1989
Total flight time	3,306 h
Latest training on emergency procedures	July 9, 1993
Rest period prior to the flight	More than 18 h
I. Flight attendant (female, aged 24)	
Qualification as attendant	Issued May 4, 1992
Total flight time	1,513 h
Latest training on emergency procedures	July 2, 1993
Rest period prior to the flight	More than 18 h
J. Flight attendant (female, aged 25)	
Qualification as attendant	Issued June 2, 1992
Total flight time	1,401 h
Latest training on emergency procedures	July 1, 1993
Rest period prior to the flight	More than 18 h
K. Flight attendant (female, aged 24)	
Qualification as attendant	Issued August 20, 1992
Total flight time	1,289 h
Latest training on emergency procedures	July 14, 1993
Rest period prior to the flight	More than 18 h
L. Flight attendant (female, aged 23)	
Qualification as attendant	Issued April 26, 1993
Total flight time	720 h
Latest training on emergency procedures	June 30, 1993
Rest period prior to the flight	More than 18 h

M.	Flight attendant (female, aged 23)	
	Qualification as attendant	Issued January 4, 1994
	Total flight time	170 h
	Latest training on emergency procedures	January 4, 1994
	Rest period prior to the flight	More than 18 h

2.6 Aircraft Information

2.6.1 Aircraft

Type	Airbus Industrie	A300B4-622R
Serial No.		580
Date of manufacture		January 29, 1991
Certificate of airworthiness		83-01-05
Valid until		January 15, 1995
Total aircraft flight time		8,572 h 12 min

2.6.2 Engines

Type	Pratt and Whitney PW-4158	
	No. 1	No. 2
Serial No.	724082	724025
Date of manufacture	December 13, 1990	October 5, 1989
Total hours of operation	5,776 h	8,783 h

2.6.3 Weight and Center of Gravity

The weight of the aircraft at the time of the accident is estimated to have been approximately 290,900 lbs, with its center of gravity at 30.6% MAC, both being within permissible limits (maximum landing weight being 308,651 lbs, with the allowable range of center of gravity corresponding to the weight at the time of landing, 20.0 to 33.6% MAC).

According to the Flight Clearance and Log of China Airlines, the aircraft loaded approximately 50,700lbs of fuel before takeoff. The amount of fuel remaining at the time of the accident is estimated to have been approximately 22,000lbs.

2.6.4 Fuel and Lubricating Oil

The fuel on board was JET A-1, and the lubricating oil was Esso Turbo Oil 2380 (MIL-L-23699), both being authorized for aircraft use.

2.7 Meteorological Information

2.7.1 Synoptic Weather

The synoptic weather announced by the Nagoya District Weather Service Center of the Metrological Agency at 1100 (JST) on April 26, 1994 was as follows:

A region of high atmospheric pressure, centered above the Korean Peninsula and the East China Sea covers almost all of Japan. Meanwhile, a front associated with a low pressure system hovers above the ocean to the south of Japan, and another low pressure system is centered over the ocean to the northeast of Hokkaido. Thus, the weather is fine throughout the country, except on the Pacific side of eastern Japan, and northern Japan, where it is cloudy.

Weather is fine in the Chubu region, in both the Tokai and Hokuriku areas. Also, the temperature is high. (See attached Figures 6 and 7).

2.7.2. Aeronautical Meteorological Observations and Reports

(1) Aeronautical meteorological observations at Nagoya Airport.

The routine and special aeronautical meteorological observations by the Aviation Weather Service Center at Nagoya Airport in the time zones relating to the accident (times indicated are JST) were:

19:30	Wind direction/speed:	280°/10 kts.
	Visibility:	15 km
	Cloud:	1/8 cumulus 3,000 ft 6/8 unknown
	Temperature/dew point:	20°C/5°C QNH: 29.84 inHg
20:00	Wind direction/speed:	280°/8 kts.
	Visibility:	20 km
	Cloud:	1/8 cumulus 3,000 ft 6/8 unknown
	Temperature/dew point:	20°C/4°C QNH: 29.86 inHg
20:19	Wind direction/speed:	280°/6 kts.
	Visibility:	20 km
	Cloud:	1/8 cumulus 3,000 ft 6/8 unknown
	Temperature/dew point:	19°C/4°C QNH: 29.87 inHg
20:30	Wind direction/speed:	280°/7 kts.
	Visibility:	20 km
	Cloud:	1/8 cumulus 3,000 ft 4/8 unknown
	Temperature/dew point:	19°C/4°C QNH: 29.87 inHg

- (2) Aeronautical meteorological reports at Taipei International Airport
Aeronautical meteorological reports by the Taiwanese civil aviation authorities in the time zones relating to the departure of the aircraft were:

8:00	Wind direction/speed:	050°/14 kt
	Visibility:	8 km, light rain
	Cloud:	SCT 600 ft, BKN 1,000 ft, OVC 4,000ft
	Temperature/dew point:	23°C/19°C QNH: 29.83 inHg
8:30	Wind direction/speed:	050°/11 kt Gust 22 kt
	Visibility:	8 km, light rain
	Cloud:	SCT 500 ft, BKN 1,000 ft, OVC 4,000 ft
	Temperature/dew point:	22°C/19°C QNH: 29.83 inHg
9:00	Wind direction/speed:	070°/8 kt Gust 18 kt
	Visibility:	5 km, light showery rain
	Cloud:	SCT 500 ft, BKN 1,000 ft, OVC 4,000 ft
	Temperature/dew point:	23°C/19°C QNH: 29.82 inHg

2.8 Navigation Aids

All navigation aids at Nagoya Airport required for aircraft the operation of the aircraft concerned were in working normally during the time zone related to the flight.

2.9 Communications

The aircraft maintained communication with Tokyo Control (133.5 MHz and 125.7 MHz), Nagoya Approach (120.3 MHz) and Nagoya Tower (118.7 MHz). Communication with these facilities was good.

2.10 Airport and Ground Facility Information

Nagoya Airport is located in Toyoyama-cho, Nishikasugai County, Aichi Prefecture, about 10 kilometers north-northeast of Japan Railways' Nagoya Station, and is administered by the Ministry of Transport.

Field elevation of the airport is 14 meters. The runway, 16 and 34, is 2,740 meters long and 45 meters wide. It is paved with asphalt concrete, and has grooving over a 2,708-meter long and 30-meter wide area.

The runway was in normal operation at the time that the aircraft was making its landing approach. (See attached Figure 8.)

2.11 Information on DFDR and CVR

The aircraft was equipped with a Sandstrand model 980-4100-BXUS DFDR (serial No. 1006) and a Fairchild model A100A CVR (serial No. 25153). (See attached Photographs 43 and 44)

The DFDR case was partially crushed and damaged when recovered. However, its magnetic tape that had recorded signals during the flight, was found intact.

The DFDR record is attached herewith as Appendix 6.

The CVR was also recovered with its case partially crushed and damaged, but its tape, containing a record of voices and sounds was not damaged.

The CVR had four recording channels, each channel being assigned to an input source as shown below, and recorded radio communication and other voices.

The CVR transcriptions are shown in Appendix 7.

Channel 1: Input from the audio selector panel of the jump seat (3rd)

Channel 2: Input from the audio selector panel of F/O's seat (F/O)

Channel 3: Input from the audio selector panel of CAP's seat (CAP)

Channel 4: Input from the area microphone (AREA MIC)

It should be noted that Channels 2 and 3, including radio communication, are identical because the CAP and the F/O always used the cockpit intercom system.

2.12 Medical Information

2.12.1 Autopsies of CAP, F/O and Purser

Information supplied by Aichi Prefectural Police Headquarters is as follows:

(1) Damage to bodies and handling of remains prior to autopsies

The CAP's body had open wounds running from the right shoulder to the right breast.

Open wounds were also found from the left breast to the left abdomen of the F/O's body, and his stomach and intestines were damaged.

Open damage was barely noticeable on the breast and abdomen of the purser's body.

The three remains were placed in Hangar 1 of the Komaki Air Base immediately after their recovery.

Later, no special measures, such as preservation by freezing, were taken for the remains prior to their transfer to three medical colleges/university for judicial autopsies.

From 18 to 22 hours had elapsed from the time of the accident to the transfer of the remains to the medical colleges/university for autopsy. During this period, the lowest and

highest temperatures at Nagoya Airport were about 10°C and 23°C, respectively.

The temperature in the Hangar 1 of the Komaki Air Base, where remains were placed, is considered to have been somewhat higher than the value above.

(2) Judicial autopsies and extraction of samples for alcohol reaction tests (times are JST)

① CAP

A post-mortem examination was conducted on the CAP's body at a dissection room of legal medicine at Department of Medicine, Nagoya University, between 17:55 and 23:00 on April 27.

Test samples were taken from the thoracic cavity using an anatomical spoon in a period between 20:00 and 21:00. Some 24 to 25 hours had elapsed from the time of the accident to when the samples were taken.

② F/O

A post-mortem examination was conducted on the F/O's body at a dissection room of legal medicine and pathology at Aichi Medical College, between 14:00 and 17:00 on April 27.

Test samples were taken from the thoracic cavity with an anatomical spoon at about 15:00. This was done approximately 19 hours after the time of the accident.

③ Purser

A post-mortem examination was conducted on the purser's body at a dissection room of legal medicine at School of Medicine, Fujita-Gakuen Health College, between 14:00 and 17:00 on April 27.

Test samples were taken from the heart using an anatomical spoon about 15:30, approximately 19 hours after occurrence of the accident.

(3) Alcohol reaction test

The test samples taken from the three remains were immediately placed in special plastic containers and sealed. After dissection, technical officers from Aichi Prefectural Police Headquarters who had witnessed the dissection, took the samples to Scientific Investigation Laboratory of Aichi Prefectural Police Headquarters for storage in a refrigerator.

① Date of test and organization involved

An alcohol reaction test was conducted at the above-mentioned Scientific Investigation Laboratory in a period between 17:00 and 20:00 on April 28.

② Test method

One milliliter of each test sample was subjected to test by the gas chromatography method using n-propanol as an internal standard. The concentration of ethanol was calculated by the calibration curve method.

③ Test results

The concentration of ethanol in each of the test samples was as follows:

- (a) CAP : 13 mg/100 ml
- (b) F/O : 55 mg/100 ml
- (c) Purser : No ethanol detected

2.12.2 Injuries to survivors

Of the 271 persons aboard -- 256 passengers and 15 crew members -- 16 passengers were taken to hospital by ambulance. Six of them were found dead on arrival at the hospitals.

In addition, three passengers died after hospitalization, on April 27, April 28, and May 1, respectively.

Seven passengers survived -- all of them had been seated in Rows 7 through 15. Four had been in the right block of seats, two in the center block, and one in the left block. (See attached Figure 26.)

At the time of hospitalization, all seven survivors were suffering from traumatic shock to various degrees. Various external wounds, primarily bone fractures caused by the impact, were found among the survivors, the locations of which differed from one to another. According to the diagnosis, those serious injuries would take from two months to an year to heal completely.

2.12.3 Damage to Bodies

According to the autopsy reports, a great number of the remains were bruised all over and had suffered multiple fractures caused by the impact.

Nearly half of the remains had been burnt to various degrees.

2.13 Fire and Fire Fighting

2.13.1 Fire Fighting and Rescue System at Nagoya Airport

(1) Outline of fire fighting and rescue organizations at Nagoya Airport

The fire fighting and rescue service for civil aircraft at Nagoya Airport is to be provided by the Nagoya Airport Office (hereinafter referred to as "Airport Office") with assistance rendered to the office by the Komaki Air Base, in accordance with an agreement on mutual assistance in fire fighting and rescue activities made between the Administrator of Nagoya Airport Office of Osaka Regional Civil Aviation Bureau (hereinafter referred to as "Airport Office Administrator") and the commander of Komaki Air Base of Air Self-Defense Force.

Also, an agreement was made with respect to the fire fighting service in and around Nagoya Airport between the Airport Office Administrator, and the Chief of Fire Fighting Headquarters of Nishikasugai County East Fire Fighting Association, the Chief of Komaki City Fire Fighting Headquarters, the Chief of Kasugai City Fire Fighting Headquarters, and the Chief of Nagoya City Fire Fighting Bureau (hereinafter referred to as "Neighboring Fire Fighting Organizations"). This agreement allows the Airport Office Administrator to request assistance to these Neighboring Fire Fighting Organizations when necessary.

Furthermore, an ambulance loaded with emergency medical materials and equipment was stationed at Nagoya Airport from March 1992, and the Airport Office commissioned the Air Safety Foundation to operate this vehicle.

(2) Fire fighting equipment and personnel at Nagoya Airport

The fire fighting equipment was not provided at the Airport Office. The Fire Fighting Platoon of the Base Operation Facilities Company of First Air Transport Squadron at Komaki Air Base (hereinafter referred to as "Fire Fighting Platoon"), is equipped with five chemical fire vehicles and one water supply wagon. This Fire Fighting platoon operates 24 hours a day, in shifts, at the station which contains a fire trucks and a command office, and is situated in the eastern part of Nagoya Airport.

Meanwhile, according to "Level of Protection to be provided" specified as a recommended practice in Annex 14 ("AERODROMES") to the Convention on International Civil Aviation, Nagoya Airport is classified as a Category 9 Airport. Nagoya Airport complies with the applicable level in terms of the amounts of water for foam production, fire-extinguishing agents and complementary agents, and response time. However, the airport did not meet the level in respect of the discharge rate for foam solution.

The chemical fire vehicles had a discharge distance of 30 m.

(3) Fire fighting and rescue training for aircraft accidents

Fire fighting and rescue training for aircraft accidents were held at Nagoya Airport on October 16, 1989 and May 24, 1993, under the auspices of the Airport Office. Personnel from Self-Defense Force, Neighboring Fire Fighting Organizations, Airport Police Station, Aichi Prefecture Medical Association, and other organizations participated in these traoining.

In order to train its fire fighting personnel, the Fire Fighting Platoons conduct drills involving actual fires once a quarter-year and practice water spraying once a week.

2.13.2. Fire Fighting Activities (times are JST)

(1) Request for mobilization and turning out of fire vehicles

At about 2016, via an emergency telephone call, an Air Traffic Controller of the Airport Office (hereinafter referred to as "Controller") requested the Fire Fighting Platoon and an Air Traffic Information Officer (hereinafter referred to as "Information Officer") to dispatch fire

services for an aircraft crash in which fire had broken out.

At about 2017 the Fire Fighting Platoon dispatched three chemical fire vehicles.

Meanwhile, as specified in the emergency notification network chart, the Information Officer requested the Fire Fighting Headquarters of Nishikasugai County East Fire Fighting Association and Airport Police Station to request assistance.

The Fire Fighting Headquarters of Nishikasugai County East Fire Fighting Association relayed the information to the Kasugai city Fire Fighting Headquarters, Nagoya City Fire Fighting Bureau, and the Komaki City Fire Fighting Headquarters.

At about 2019 three chemical fire vehicles of Fire Fighting Platoon were the first to arrive at the crash site, and immediately began fire extinguishing activities.

At approximately 2027, one chemical fire vehicle, one water tank truck, one rescue vehicle, and one ladder truck, all from the Fire Fighting Headquarters of Nishikasugai County East Fire Fighting Association, as well as two chemical fire vehicles, two water tank trucks, and two rescue vehicles from the Kasugai City Fire Fighting Headquarters, entered the airport through the No. 2 West Gate and proceeded to the crash site under the guidance of Airport Office personnel, where they commenced fire extinguishing activities.

Around 2030 two chemical fire vehicles, one ordinary fire vehicle, one water supply wagon, one cargo truck, one water spray truck, two mobile cranes, one light wrecker, one fork-lift, and one tractor, all from the Fire Fighting Platoon, reached the site as second group, and commenced fire fighting activities.

At approximately 2042, one chemical fire vehicle, one water tank truck, and one rescue vehicle from the Komaki City Fire Fighting Headquarters entered the airport after cutting two sets of security chains at the North Gate and opening the gate, arrived at the crash site, and commenced fire fighting activities. In addition, about 2054, a chemical fire vehicle from the Nagoya City Fire Fighting Bureau entered the airport through the No. 2 West Gate and went into action at the crash site.

(2) Fire extinguishing activities

Fire fighting personnel who were dispatched from the standby station of Fire Fighting Platoon described the fire fighting activities as follows:

At approximately 2016 of that day, the Controller informed the Fire Fighting Platoon via an emergency telephone that “a China Airlines' aircraft has burst into flames on the runway” and requested fire services. The Fire Fighting Platoon dispatched three chemical fire vehicles around 2017.

The Fire Fighting Platoon personnel, who were at their standby station, had not heard the impact sound of the aircraft crash.

Upon receipt of the report, two chemical fire vehicles left the station and sped along Taxiway E4 and the runway to the southern end of the airport where flames and smoke were billowing in the air. About 2019, another chemical fire vehicle arrived at the site via Taxiway EP1.

The aircraft had fragmented into pieces, losing its original shape so badly that the only way to distinguish the wings was by identifying the vague shape of the engines.

Fire broke out, and flames as high as a three-storied building enveloped an area more than 100 meters wide. Booming sounds were heard three times at intervals.

Going into action immediately, the Fire Fighting Platoon, staying clear of widely scattered aircraft fragments, advanced to about 20 meters from the wing and discharged fire extinguishing agents.

At approximately 2027, a chemical fire vehicle, a water tank truck and a ladder truck from the Fire Fighting Headquarters of Nishikasugai County East Fire Fighting Association, plus two chemical fire vehicles and two water tank trucks from the Kasugai City Fire Fighting Headquarters arrived at the crash site and went into action. Flames under the wings, however, did not abate easily.

About 2030, a second party dispatched by the Fire Fighting Platoon, consisting of two chemical fire vehicles, one water supply truck, one ordinary fire vehicle, one cargo truck and so on arrived at the site. They backed up the chemical fire vehicles that had arrived earlier and provided them with additional water and fire extinguishing agents.

Around 2042, a chemical fire vehicle and a water tank truck from the Komaki City Fire Fighting Headquarters arrived at the crash site and joined the fire extinguishing activities.

Later, about 2054, a chemical fire vehicle from the Nagoya City Fire Fighting Bureau arrived at the site and also joined the fire fighting activities.

About 2110, aircraft components smoldering near the irrigation water channel were cut open with axes and tobiguchi (fireman's hooks) and sprayed with agents and water. The fire was finally extinguished around 2148.

2.14 Information on Search, Rescue and Evacuation Relevant to Survival, Death or Injury

2.14.1 Information on Search and Rescue Activities (times are JST)

(1) Removal of passengers

After confirming the crash site, the personnel from the Self-Defense Force, Neighboring Fire Fighting Organizations, Police, and Airport Office conducted search and rescue activities throughout the area.

Reports from the various parties are summarized as follows:

Ambulances from Komaki Air Base arrived at the crash site at about 2019 and 2023.

At about 2027, ambulances and other vehicles from the Fire Fighting Headquarters of Nishikasugai County East Fire Fighting Association and the Kasugai City Fire Fighting Headquarters entered the airport through the No. 2 West Gate and, upon arriving at the site, commenced search and rescue operations promptly.

At approximately 2031, ambulances from Nagoya City Fire Fighting Bureau entered the airport through the No. 2 West Gate and proceeded to the crash site. Upon arrival, the ambulance men started confirming whether there were any survivors and conducting first aid to the injured. Actual work to confirm the presence of survivors began about 2032. However, flames raging in the central part of the fuselage hampered search and rescue activities.

A male passenger was found around 2035, and two female passengers and an infant were removed from the site about 2037. These four people were carried to hospital in an ambulance from Komaki Air Base.

Around 2042, ambulances from the Komaki City Fire Fighting Headquarters entered the airport

through the main gate of Komaki Air Base and commenced search and rescue activities.

Two injured passengers, who had received first aid from the rescue personnel assigned to a Nagoya City Fire Fighting Bureau ambulance, were rushed to hospital.

Around 2049, an ambulance from the Fire Fighting Headquarters of Nishikasugai County East Fire Fighting Association carried three passengers to hospital.

Around 2055, two ambulances from the Kasugai City Fire Fighting Headquarters took three passengers to hospital.

Around 2100, a male passenger about 40 years old, trapped between seats, was rescued by removing the seats with a power cutter. A female passenger about 35 years old was also rescued. Those two passengers were carried to hospital in an ambulance from the Kasugai City Fire Fighting Headquarters.

Around 2100, a male child passenger was taken to hospital in an ambulance from the Fire Fighting Headquarters of Nishikasugai County East Fire Fighting Association.

At approximately 2122, an emergency medical treatment and transport vehicle arrived at the crash site.

Around 2124, an ambulance from Nagoya City Fire Fighting Bureau carried a male passenger to hospital.

Around 2140, rescue teams began setting up rescue stations (three air tents).

Around 2148, the fire was finally extinguished. Wreckage was pulled up from the irrigation water channel with cranes and other equipment, and the search for missing persons continued.

From about 2220 the remains found around the wings and the irrigation water channel were taken to the rescue stations (air tents).

On request from the Airport Office Administrator, troops of 10th Division, with Ground Self-Defense Force, from Moriyama Base, arrived at the site about 2225, and commenced search and rescue activities.

Around 2325, the remains of persons considered to be crew members were found near the cockpit and taken to a rescue station (air tent) set up near the crash site.

Around 0445 on April 27, transfer of remains from the rescue stations (air tents) to Hangar No. 1 at Komaki Air Base, for temporary storage, started.

Around 1340, the final remain was transferred from the site. (See attached Photograph 4.)

(2) Rescue activities conducted by the organizations involved

① On April 26, based on a decision made at a cabinet meeting immediately after the accident, Japan's national government established "China Airlines Aircraft Accident Countermeasure Headquarters", with the Minister of Transport as its head. The government decided to spare no effort in rescuing survivors, recovering the remains and keeping close contact with the organizations involved.

② Immediately after the accident, the Airport Office set up "Accident Emergency Countermeasure Headquarters" with the Airport Office Administrator as its head and mobilized 119 employees through emergency call. The Airport Office also organized "Nagoya Airport Aircraft Rescue Unit" and conducted its activities using the following personnel, materials and equipment:

Personnel 406 persons (including 102 of Rescue Unit and other

- airport personnel concerned)
- | | |
|-------------------------|--|
| Materials and equipment | 28 vehicles (including an emergency medical treatment and transport vehicle) and 3 air tents |
|-------------------------|--|
- ③ With a request from the Airport Office Administrator for disaster dispatch immediately after the accident, the 10th Division of Ground Self Defense Force and the 1st Air Transport Squadron of Air Self-Defense Force participated in the rescue and other activities by providing:
- | | |
|-------------------------|--|
| Personnel | 1,900 persons (1,200 at the site and 700 for backup duties) |
| Materials and equipment | 25 vehicles |
| Floodlight projectors | 16 |
- ④ The Fire Fighting Headquarters of Nishikasugai County East Fire Fighting Association, Kasugai City Fire Fighting Headquarters, Komaki City Fire Fighting Headquarters, and Nagoya City Fire Fighting Bureau participated in rescue and other activities at the request of the Airport Office, by providing:
- | | |
|-------------------------|--|
| Personnel | 546 persons (534 dispatched and 12 on standby) |
| Materials and equipment | 116 vehicles |
| Helicopter | 1 (operated by Nagoya City Fire Fighting Air Force; used illuminate the crash site and assess the scope of the disaster by flying over the site) |
- ⑤ In accordance with the “Agreement on Medical Treatment and Rescue Activities at Nagoya Airport” made with the Airport Office, the Aichi Prefecture Medical Association conducted their rescue activities by providing:
- | | |
|------------|--|
| Dispatched | 64 persons (47 doctors and 17 nurses) |
| On standby | 164 persons (76 doctors, 51 nurses and 37 clerks and others) |
- ⑥ The Aichi Prefecture Branch of Japanese Red Cross Society conducted activities, including autopsies, post-mortem examinations, reconstruction, cleansing and identification, by providing:
- | | |
|-----------|--|
| Personnel | 102 persons (14 doctors, 55 nurses and 33 clerks and others) |
|-----------|--|
- ⑦ The Aichi Prefectural Police Medical Association performed post-mortem examinations by providing:
- | | |
|-----------|------------|
| Personnel | 79 persons |
|-----------|------------|
- ⑧ The Aichi Prefecture Dental Association was engaged in identification activities by providing:
- | | |
|-----------|--|
| Personnel | 134 persons (107 dentists, 7 dental hygienists, and 20 police doctors) |
|-----------|--|

- ⑨ Upon receipt of the accident report from the Airport Office immediately after the crash, the Aichi Prefectural Police Headquarters conducted rescue activities and policed the site of disaster by providing:

Personnel 1,700 persons (1,100 dispatched and 600 others)

2.15 Tests and Research to Find Facts

2.15.1 Investigation of Traces Left on the Ground

At the crash site, there were clear scars that had been left on the ground when the tail assembly, trailing edges of both LH and RH wings, LH and RH main landing gears, LH and RH engines, nose landing gear, and other aircraft parts had first hit the ground. There were also linear scars extending through the area to where the wreckage was strewn.

The aircraft first impact point was in the landing area, some 110 meters east-northeast from the center of the end of Runway 34. The crash site was covered with earth and sand, and the ground was relatively soft.

Measurements of the major marks are as follows:

	Width (cm)	Length (cm)	Depth (cm)	Angle of entry(°)
Nose landing gear	130 to 150	440	41	42
LH main landing gear	170 to 220	470	67	23
RH main landing gear	30 to 210	500	38	16
LH engine	150 to 320	920	73	10
RH engine	170 to 390	910	68	12
LH No. 2 flap track	27 to 46	375	10	24
LH No. 3 flap track	21 to 38	510	29	34
LH No. 4 flap track	26 to 47	570	--	25
LH No. 5 flap track	25 to 43	560	21	26
LH No. 6 flap track	20 to 46	540	30	30
RH No. 2 flap track	38 to 48	--	20	14
RH No. 3 flap track	27 to 38	210	10	14
RH No. 4 flap track	28 to 44	530	18	20
RH No. 5 flap track	24 to 39	410	24	16
RH No. 6 flap track	33 to 80	270	33	20

The positions of the marks left by the nose landing gear, LH and RH main landing gears, LH and RH engines, LH and RH wingtips, and THS are as shown in attached Figure 10.

The direction of the linear marks which are made when the center section of the fuselage scratched the ground, coincided with magnetic bearing of about 22°. (See attached Figures 9, 10, and Photographs 49 and 50.)

2.15.2 Indications of Major Instruments and Positions of Switches and Levers

Regarding indications of major instruments as well as the positions of switches/levers in the cockpit, the following are identified.

(1) Indications of major instruments

- Altimeter (unknown whether LH or RH): QNH 29.82/1010 80 ft
- Rate of climb indicator (unknown whether LH or RH): -6,000 ft
- RMI (unknown whether LH or RH): Heading 020°
- ENG oil pressure indicator/oil quantity gauge: No.1 225 psi/12.5 Qr No.2 -/-

(2) Positions of switches and levers

- IRS mode selectors: No. 1: OFF, No. 2: ATT, No. 3: NAV
- ENG IGN selectors: No. 1: Cont Relight, No. 2: Cont Relight
- L/G lever: Intermediate position between Neutral and Down
- SLTS/FLPS lever: 15/20°
- THS trim indicators: 9.4°/9.5°
- SPD brake lever: RET
- ENG SWs: No. 1: ON, No. 2: ON
- THR levers: No. 1: 34°, No. 2: 34°
- THR reverser levers: RET
- Fire handles: Handles for No. 1 engine, No. 2 engine and APU had not been activated.
(See attached Photographs 35,36,37,38,39,40 and 41.)

2.15.3 Disassembly Inspection of Engines

A thorough investigation of the engines was conducted through the methods, including teardown inspection.

With respect to No. 1 engine, the investigation focused on parts between LPC and LPT rotors. Investigation of No. 2 engine covered parts between the core of LPC and HPT rotor (stage No. 2). In addition, following items of both engines are also investigated: Principal accessories (fuel oil coolers, stator vane actuators, 2.9 bleed valves, fuel metering units, fuel and oil pumps), and oils collected at the crash site (fuel, engine oil, and hydraulic fluid).

The results of the investigation are as follows:

- (1) The fracture surfaces of all broken parts of both engines showed signs of rapid destruction, but there was no indications of fatigue damage or melting. The damage to the No. 1 engine was more prominent than to the No. 2 engine.

- (2) Rotor blades had been torn/deformed in the direction opposite to that of engine rotation. Stator vanes and nozzle guide vanes had been torn/deformed in the direction of engine rotation.
- (3) The external surfaces of both engines showed evidence of burns. The No. 2 engine was burnt more extensively than the No. 1 engine, with its HPC blade surface, front case and so on surfaces partially blackened. There was no indication of in-flight fire; all signs of fire indicated that fire had broken out only after the engines were destroyed.
- (4) Nothing indicative of operational abnormality was found in the damage to major accessories. The fracture surfaces of all broken and damaged accessories showed signs of rapid destruction.
- (5) All oils collected at the crash site (fuel, engine oil, and hydraulic fluid) contained a great deal of foreign matter such as water, mud, grains of sand, and other fiber-like objects, and they were found polluted and deteriorated, making it difficult to determine the conditions they had been in before the crash. (See Attached Figure 20 and 21.)

2.15.4 Investigation of FADECs

The aircraft engines were equipped with Full Authority Digital Electronic Controls (FADECs) manufactured by Hamilton Standard of United Technologies Corp. (Serial No.: 4000-0519 for No. 1 engine and 4000-0674 for No. 2 engine).

The connectors of both FADECs had broken; the FADEC for the No. 2 engine was recovered with its case cracked.

The FADECs had a dual system consisting of channels A and B. Their disassembly inspection showed that the processor boards for both channels in each FADEC were in good conditions. The fault memories storing the engine control failure condition records were readable on all the channels. As a result of the analysis of these records, evidence of surges which indicate a rapid drop of pressure in the engine combustor in flight before crash, was detected in channels A and B of the FADEC for both engines (See Photograph 32).

2.15.5 Investigation of Computer Memories

Computers with non-volatile memories, which are considered useful for crash cause determination, were recovered from the site.

All these computers were damaged by the impact. The memories from all recovered computers, except heavily damaged ones, were investigated. These computers are the following.

Marked with asterisks (*) are computers whose memories were not readable owing to internal damage.

* (1)	Flight control computer (FCC)	1 pc
(2)	Flight augmentation computer (FAC)	2 pcs
(3)	Flight management computer (FMC)	1 pc
* (4)	Center of gravity control computer (CGCC)	1 pc
(5)	Symbol generating unit - Electronic flight instrument system (SGU-EFIS)	3 pcs
(6)	Symbol generating unit - Electronic centralized aircraft monitor (SGU-ECAM)	2 pcs
(7)	Flight warning computer (FWC)	1 pc
(8)	Air data computer (ADC)	2 pcs
(9)	Inertial reference unit (IRU)	3 pcs
(10)	Generator control unit (GCU)	2 pcs
* (11)	Maintenance and test panel (MTP)	1 pc
* (12)	Ground proximity warning computer (GPWC)	1 pc
(13)	Instrument landing system (ILS) receiver	1 pc

2.15.6 Information on Seating Positions of CAP and F/O

2.15.6.1 CVR records

The voice records on CH2 and CH3 of CVR, including radio communications, were identical because the cockpit intercom transmission system was always used by the CAP and the F/O. So which of the two seats the CAP or the F/O occupied could not be determined from the CVR. However, the transcripts are as follows:

- (1) Conversation made between 1046:59 and 1047:35
The conversation is concerned with the operation of "lights".
Lights in the cockpit consists of the following:
 - ① Lights operated from CAP's seat through controls on CAP and center light panel located at the left end of the instrument panel:
 - CAP and center instrument light
 - Main instrument panel floodlight
 - Console floodlight
 - Map light
 - ② Lights operated from F/O's seat through controls on F/O instrument light panel at the right end of the instrument panel:
 - F/O instrument light
 - Console floodlight
 - Map light
 - ③ Lights operated from CAP's or F/O's seat through a knob located at the center of the overhead panel:
 - Reading light

- ④ Lights operated from CAP's or F/O's seat through a knob on the pedestal:
 - Pedestal and overhead panel light
- ⑤ Lights operated from CAP's seat (also from F/O's seat) through controls on the cockpit light panel in front of the overhead Panel CAP's seat:
 - Dome light
 - Storm light
- ⑥ Lights operated from CAP's or F/O's seat through the glareshield lightning controls :
 - Each window of the glareshield panel
 - Push-button switch integrated light (See attached Figure 23 and Photograph 42.)

(2) Conversation started at 1100:02

The conversation was concerned with the wearing of shoulder harnesses.

2.15.6.2 Setting of CAP's seat and F/O's seat

Investigation was made on the wreckage of the CAP's seat and RH(F/O) crew seats as to marks left presumably by the impact on the column assemblies, which are related to the seats' vertical positions, and those on the seat position track, which are related to the seats' longitudinal positions. Measurements obtained from these marks were as follows:

	Column assembly	Seat position track
LH (Captain) Seat	Approx. 70 mm upward from the lowest position	Probably near the forward-most position
RH(F/O) Seat	Approx. 30 mm upward from the lowest position	Approx. 33mm rearward from the forward-most position

Note: The mark found at a point 170 mm from the forward limit position of the LH(Captain) seat is not considered to be primary damage caused by the crash impact -- it is regarded as secondary damage caused afterward.

The position where the LH side rudder pedals had been placed was judged to be approximately 17 mm forward of its rearmost position, based on a mark left on the recovered rudder pedal adjuster. The right-side rudder pedal adjuster was not recovered.

According to their airman medical certificates, the CAP and the F/O were 162.5 cm and 178.1 cm tall, respectively. (See attached Figures 24 and 25.)

2.16 Other necessary Information

2.16.1 Flight Experience of CAP and F/O

The following information has been obtained from China Airlines:

- (1) The CAP joined China Airlines on February 1, 1989. Before this, he had served in the Taiwanese Air Force as a pilot from September 1970 to January 1989. During his military service, he had accumulated 4,826.5 hours' flight experience with C-47s and other aircraft. After joining the airline, he served as F/O for B747-200 and B747-400. During this period, he underwent CAP training for A300-600R at China Airlines and qualified as CAP for the aircraft type on July 31, 1992. He was promoted to CAP for A300-600R on December 1, 1992. His flight hours until April 25, 1994, the day preceding the accident were:

Duty/Aircraft type	Air Force	B747-200	B747-400	A300-600R	Total
CAP	4826+30	--	--	1089+34	5916+04
CAP training	--	--	--	260+53	260+53
F/O	--	668+35	1494+47	--	2163+22
Flight time	4826+30	668+35	1494+47	1350+27	8340+19

(Total flight hours in China Airlines: 3513+49)

- (2) The F/O joined China Airlines as a candidate pilot on April 16, 1990. He received flight training at University of North Dakota (UND), under the airline's training program, from August 4, 1991 to August 30, 1992, flying some 590 hours on C-90A, C-1900, and other aircraft. He obtained a commercial pilot's license after completing the program. He underwent classroom and simulator training and three hours' flight training for A300-600R at Aeroformation in France. China Airline contracted this trainings to Airbus Industrie and then Airbus Industrie subcontracted these to Aeroformation. Subsequently the F/O underwent four hours' basic flight training at China Airlines, and qualified as F/O for the aircraft type on December 29, 1992; he was promoted to F/O for A300-600R on March 22, 1993. His flight hours until April 25, 1994, the day before the accident was:

Duty/Aircraft type	UND	A300-600R	Total
CAP	343+30	--	343+30
F/O	246+42	1033+59	1280+41
Flight time	590+12	1033+59	1624+11

2.16.2 Qualification Requirements for CAP and F/O, and Promotion System

China Airlines established its internal rules and regulations in accordance with Taiwanese laws, and set up criteria for qualification and promotion as described below. Both the CAP and the F/O satisfied the qualification requirements for their respective duties to fly aircraft of

the type in question.

(1) Qualification Requirements

① CAP

Age: 54 or younger
Competence qualification: Airline transport pilot
Experience: Not less than 2 years' service as F/O with qualification for promotion to CAP
Medical certificate: Class 1
Flight hours: Not less than 3,500 hours

② F/O

From military service

Academic background: Graduate of Aviation Department of Air Staff College, Air Force
Age: 33 to 45
Competence qualification: Commercial pilot
Medical certificate: Class 1

Flight hours: Not less than 1,300 hours : age 33
Not less than 1,400 hours : age 34
Not less than 2,500 hours : age 45

Trained by the Chinese Airline

Academic background: Graduate of Engineering Department of Junior College or higher
Age: Less than 28
Competence qualification: Commercial pilot
Airman medical certificate: Class 1
Flight hours: Not less than 588 hours

(2) Promotion system to F/O and CAP

F/O for light aircraft type (C-90A, C-1900, etc.)

↓

F/O for lower-ranked aircraft type (B737, A300B4, A300-600)

↓

F/O for higher-ranked aircraft type (B747-200, B747-400, MD11)



F/O recommended as candidate for CAP by the company



CAP for lower-ranked aircraft type (B737, A300B4, A300-600)



CAP for higher ranked aircraft type (B747-200, B747-400, MD11)

(Note): Depending on education and career, some pilots may become F/O for higher ranked aircraft from the start.

2.16.3 Automatic Flight System (AFS) (See Attachment 1)

(1) Summary of AFS of A300-600R type aircraft

Summary of AFS of A300-600R type aircraft is shown in Appendix 1.

(2) Caution against FCOM concerning the AP override.

With regard to the aircraft involved in the accident, when the AP is engaged in LAND and GO AROUND modes, movement of the elevators by the AP can be overridden by pushing and/or pulling the control wheel. In this case, however, the AP autotrim orders are not canceled, and the AP will move the THS so as to maintain the aircraft on the scheduled flight path. The aircraft will eventually read to out-of-trim condition.

With regard to this hazardous situation, a “ CAUTION ” is provided in the FCOM.

(Refer to Appendix 2-2)

3. ANALYSIS

3.1 Analysis

3.1.1 Establishments of the times recorded on CVR and DFDR

3.1.1.1 CVR Recordings

The times not recorded on the CVR were determined as follows:

The times were established by utilizing the fact that ATC communications recorded on the CVR were correlated with ATC communications recorded on the ATC recorders installed at Tokyo Air Traffic Control Center and Nagoya Airport Office (which follow JST time).

Taking into account possible errors in the correlation process, it is recognized that the CVR stopped recording at approximately 1115:45.

3.1.1.2 DFDR Recordings

Various data are recorded continuously in digital PCM signals onto magnetic tape in the DFDR at various with its sampling rates ranging from eight (8) times per second to every 4 seconds.

Data regarding altitude, speed, and bearing are recorded every second. Data regarding time and engine are recorded every four (4) seconds. Data such as acceleration are recorded at a higher sampling rate of four (4) to eight (8) times per second. All the data are incremented every 4 seconds as one frame.

The cockpit clock times on the panel on F/O's side are also recorded on the DFDR. However, the times are not necessarily synchronized with UTC, so the DFDR times were calibrated as follows: radio communications keying data were recorded on DFDR. By correlating these keying data to the times contained on the CVR transcript for the ATC radio communications, the times recorded on DFDR were established.

Data up until 1115:43 were recorded on the DFDR. Since the DFDR manipulates data in the method that one second of data are temporarily accumulated in buffer (as a subframe) and are recorded on magnetic tape within next 0.5 second, by taking into account possible errors in the correlation process, it is recognized that the DFDR stopped operating at approximately 1115:45.

3.1.2 Flight of the Aircraft

3.1.2.1 Estimation of Flight History

Based on data recorded on the DFDR and CVR, the flight history was estimated to be as follows (see attached Figures 1, 2, 22, 27, 28, and 29):

0853 (1700 JST) The aircraft took off from Taipei International Airport.

ca.0914 (1800 JST) The aircraft reached FL 330, and flew in accordance with its flight plan toward Nagoya Airport.

1040:17 (1900 JST) The aircraft was cleared by Tokyo Control to PROCEED DIRECT XMC (Kowa VOR/TAC), and the aircraft flew according to this clearance.

1045:45 (1900 JST) The F/O (PF) briefed the CAP (PNF) on the approach procedure to Nagoya Airport, go-around procedure, etc.

1047:35 While cruising at FL 330, the aircraft was cleared by Tokyo Control to descend to FL 210, and began its descent.

ca.1049:00-
ca.1056:00 During this period, the CAP (PNF) gave general guidance to the F/O (PF) on flight procedure and control during approach and landing .

1058:18 The aircraft's radio communication was transferred from Tokyo Control to Nagoya Approach, and the aircraft continued its approach.

1059:04 The F/O (PF) said “ . . . CHECKLIST ”. It is considered that he requested the CAP (PNF) to conduct the approach checklist.

1100:05(2000JST) The CAP (PNF) said to the F/O: “OK, FASTEN LEFT, APPROACH CHECKLIST COMPLETED.”

1100:11 The CAP (PNF) instructed the F/O (PF) to control the aircraft at his own discretion and the F/O (PF) responded by saying “YES”.

1100:12 The SLATS/FLAPS lever was moved from 0/0 to 15/0.

1102:35 The SLATS/FLAPS lever was moved from 15/0 to 15/15.

1107:22 Until this time AP No.2 had been engaged; at this time AP No.1 was additionally engaged.

1108:26 - 1110:54 Since the F/O (PF) was concerned about wake turbulence, the CAP (PNF) taught him how to deal with it, instructing him to reduce the speed from 180 kt to 170 kt in order to extend the separation between themselves and the aircraft flying ahead.

1110:52 The sound of a seat being adjusted was recorded. This is estimated from the sound spectrum of the CVR recordings which indicate that the CAP adjusted his seat upward in preparation for approach.

1111:35 With the CAP's (PNF) consent, the F/O (PF) disengaged both AP No.1 and No.2 in order to change from automatic operation to manual operation.

1111:45 The CAP (PNF) called out "GLIDE SLOPE ALIVE".

1111:46 The F/O (PF) acknowledged this and called out "go-around altitude 3,000 ft". And then GO AROUND ALTITUDE was set on ALT SEL before the FMA displayed GS STAR, as a result of which the altitude alert sounded at 1111:55. Both the CAP (PNF) and the F/O (PF) confirmed the above situation.

1112:19 The aircraft passed over the outer marker under manual control by the F/O (PF), and continued ILS approach.

1112:41 The F/O (PF) requested the CAP (PNF) to set "Flap 20", and in response to this the CAP (PNF) moved the SLATS/FLAPS lever from 15/15 to 15/20.

1112:56 The F/O (PF) requested "Gear Down" to the CAP(PNF), and the CAP responded by performing the Gear Down operation.

1113:14 The F/O(PF) called to the CAP (PNF) "30/40, speed V approach 140, landing checklist please"; the CAP moved the SLATS/FLAPS lever from 15/20 to 30/40 and called "Landing check list completed" at 13:27.

1114:05 At approximately 1,070 ft pressure altitude, the F/O (PF) triggered the GO lever. As a result, the engines' thrust began to increase, the aircraft developed a slight nose-up tendency and began to deviate above the ILS glide path. Speed also increased. Engine thrust increase was stopped at EPR 1.21 about 14:08, and was then slightly reduced to EPR between 1.17 and 1.18.
In an attempt to recover the normal descent path, the F/O (PF) performed a nose-down operation by pushing the control wheel (The THS position did not change from -5.3°).
However, the aircraft did not descend and, around 1114:10, leveled off at approximately 1,040 feet pressure altitude.

1114:09 An aural LANDING CAPABILITY CHANGE WARNING was recorded on the CVR. This sound is considered to have been caused by the change from LAND mode to GO AROUND mode.

1114:10 The CAP (PNF) cautioned the F/O (PF) by saying " You, You triggered the GO lever,", and the F/O acknowledged, saying "Yes, Yes, Yes, I touched a little."

1114:12 The CAP (PNF) instructed the F/O (PF) to "disengage it", and the F/O (PF) answered "AY".

1114:16 The CAP (PNF) said " That " and the F/O (PF) said " AY "

- 1114:18 During level flight, both AP No.2 and No.1 were engaged in CMD almost simultaneously. As the FD was in GO AROUND mode, the APs were also engaged in GO AROUND. At this time, the elevators were at 3.5° nose-down with the F/O still pushing the control wheel.
- 1114:20 As the APs were engaged, the THS began to move from -5.3° toward the nose-up direction.
In the meantime, the CVR had recorded a sound that is assumed to indicate activation of the pitch trim control switch.
It is considered that the switch was activated by the F/O (PF) in an attempt to reduce the resistive force on the control wheel. However, trimming of the THS using the pitch trim control switch is inhibited during engagement of the AP(s), so the F/O's actions had no effect.
- 1114:23 The CAP (PNF) gave the F/O (PF) an order, saying "Push down, push it down, yeah". This is considered to have been an instruction to push the control wheel down in order to correct the descent path that had become too high.
- 1114:26 The CAP (PNF) told the F/O (PF) "You, that --- disengage that throttle". This is considered to have represented the CAP's (PNF) instruction to the F/O (PF) to manually adjust the thrust by moving the throttle toward its idle position (for the same purpose as in 1114:23, i.e., to correct the descent path that had become too high).
- 1114:29 The F/O said "Too high". This is considered to have meant that the aircraft was flying above the normal descent path.
- 1114:30 On noticing that the FMA was still displaying GO AROUND mode, the CAP (PNF) said to the F/O (PF), "You, you are using the GO AROUND mode", and then added "It's OK, disengage again slowly, with your hand on".
There seems to be a possibility that in response to the CAP's instruction, the F/O took some action to change from GO AROUND mode to another mode, but this was not achieved. The words "with your hand on" seem to have two different meanings, the first being that the F/O should keep his hand on the thrust lever and the second that he should keep his hand on the button to change from GO AROUND mode to another mode.
- 1114:34 The CVR recorded a sound that is assumed to indicate activation of the pitch trim control switch. As at 1114:20, however, this operation had no effect.
- 1114:37 The THS moved to -12.30°.
- 1114:39 The CVR recorded a sound that is assumed to indicate activation of the pitch trim control switch. As at 14:20 and 1114:34, however, this operation had no effect.

1114:45 The CAP (PNF) again pointed out to the F/O (PF) "It's now in GO AROUND mode". The F/O answered, "Yes, sir".
Although there seems to be a possibility that the F/O (PF) took some action to change from GO AROUND mode to another mode, no mode change was actually made.
At and around this point of time, the pitch angle and AOA increased and the speed decreased, and to deal with this situation, the F/O increased the thrust slightly.

1114:49 The F/O (PF) said, "Sir, auto pilot disengaged" and disengaged both APs.
This action was probably taken at the F/O's (PF) own discretion or under the CAP's (PNF) instruction, but it is not clear which was the case (the conversation in the CVR record just prior to the action had been masked by another ATC communication).

1114:50 The sound of Auto Pilot disengagement was recorded on CVR.

1114:51 The F/O (PF) said, "Sir, I still cannot push it down."

1114:57 With the pitch angle and AOA still increasing, the aircraft continued to its approach with decreasing speed. At approximately 570 feet pressure altitude, the thrust increased suddenly, reaching its maximum level at 1115:03.
This is considered to have been caused by activation of the alpha floor function due to the AOA exceeding the threshold angle of 11.5° for SLATS/FLAPS 30/40 configuration.

1114:58 The CAP (PNF) said "I, that land mode?".

1115:02 The F/O (PF) reported to the CAP (PNF) : "Sir, throttle latched again".
Activation of the alpha floor function displays a symbol "THR-L" on the FMA.
Owing to the thrust increase following activation of the alpha floor function at 1114:57, the aircraft's speed and pitch angle increased; the aircraft stopped descending and began to climb.
At 1115:03, the CAP told the F/O that he would take over the controls. After doing so, the CAP pushed the control wheel to the forward limit, but the aircraft still continued to climb. Around this time the thrust levers were also temporarily retarded, suggesting that the CAP still intended to continue approach.

1115:04 The F/O (PNF) said, "Disengage, disengage." Again at 1115:09, the F/O said "Disengage, dis...". This is interpreted as a request to the CAP (PF) for the A/THR to be disengaged.

1115:08 The CAP (PF) said, "What's the matter with this ?". It is considered that the CAP's words expressed his puzzlement that the nose-up tendency was continuing, even though he had pushed the control wheel fully forward and decreased thrust.

1115:11 The CAP (PF) re-increased thrust (which he had earlier reduced) while calling "GO

lever”. At the same time, the CVR recorded the activation sound of the pitch trim control switch, and the DFDR recorded the movement of the THS in the nose-down direction.

The CAP (PF) said “Damn it, how comes like this?”. It is considered that the CAP’s words expressed his puzzlement that the aircraft pitch angle was still increasing despite his actions to the contrary (pushing the control wheel fully forward and retarding the thrust levers).

Owing to the re-increased thrust, the aircraft began a steep climb with increasing pitch angle. Speed, which had earlier increased, began to decrease.

- 1115:14 The F/O (PNF) reported go-around to Nagoya Tower.
- 1115:17 Mode 5 warning of the GPWS sounded "Glide Slope" once. It is estimated that this resulted from a detection of a pseudo-path angle that occurred at an angle 3 times greater than the normal path angle.
- 1115:18 The sound indicating passage of the SLATS/FLAPS lever through the baulk attached gates was recorded twice (see attached Figure 27).
According to normal go-around procedure, the SLATS/FLAPS lever should be moved from the 30/40 position one step higher to 15/20. However, judging from the numbers of times the SLATS/FLAPS lever sound was recorded, it may have been moved beyond the 15/20 position, perhaps to the even higher 15/0, or 0/0 position. Later, at 15:27, a sound presumably indicating the SLATS/FLAPS lever's downward movement passing through the baulk attached gate was recorded on the CVR. Also on the DFDR is a record showing that the SLATS/FLAPS lever was set on the 15/15 position at 1115:28.
- 1115:20 Both thrust levers were retarded almost simultaneously. At approximately 1115:23, the No. 1 thrust lever was retarded to the vicinity of its idle position and the No. 2 thrust lever was retarded slightly. At approximately 1115:27, both the levers were back almost to their full thrust positions.
- 1115:21 “Eh, if this goes on, it will stall,” the CAP (PF) shouted. It is presumed that this remark reflected the CAP’s (PF) shock either when he found the aircraft was continuing to climb steeply with increasing pitch angle while reducing speed, or when he noticed the position of the SLATS/FLAPS lever set by the F/O (PNF).
- 1115:23 The master caution (single chime) sounded. It was probably caused by the tripping of the yaw damper lever.
- 1115:25 The stall warning sounded for two (2) seconds and then stopped.
This was probably due to the following:
The stall warning began to sound at 1115:25 because the AOA reached

approximately 16° at 15:22, exceeding the threshold angle of 15° for the configuration SLATS EXTENDED. However, Vc dropped below 75 kts. at 1115:27, so the ADC apparently judged the AOA to be “NO MORE VALID” and terminated the warning function.

It is considered probable that around 1115:25, the aircraft fell into a stall, yet continued to climb until reaching its highest point. The aircraft remained in a stall condition until impact.

- 1115:26 The pitch angle of the aircraft reached the maximum angle of 52.56°.
- 1115:27 The THS returned to -7.4° from -12.30° where it had been at 1115:11, and then remained there until 1115:33.
It is considered that this was probably caused by the tripping of the pitch-trim lever at 1115:27.
- 1115:28 The master caution (single chime) was recorded on CVR. It is considered that this was probably caused by the tripping of the pitch-trim lever.
- 1115:31 The master caution (single chime) was recorded on CVR. It is considered that this was probably caused by the tripping of the ATS Lever. On the CVR the F/O's words, "Set, set," are recorded. It is considered that these words were probably the F/O's request to reset something when he saw CAUTION MESSAGE displayed on the ECAM. Considering the fact that the THS was moved again after about 1115:35, the F/O probably reset the pitch trim.
After reaching the highest point at approximately 1,730 ft pressure altitude, with a pitch angle of 43.8°, the aircraft began to descend, while rolling and yawing greatly to the left and right. There are records showing that corrective actions were taken by the crew by means of the ailerons and rudder during this period.
- 1115:31 The thrust decreased temporarily.
This was presumably caused by surges that occurred in both engines.
- 1115:34 From this point until just before the impact, the F/O (PF) shouted "Power" repeatedly. This was linked to his utterance of “Quick push nose down” at 1115:26 and is assumed to indicate a desire to increase thrust and thus recover lost speed.
- 1115:35 The CAP (PF) performed a nose-up operation using the control wheel.
It is considered that the CAP had until then been applying nose-down input to the elevator in order to decrease the pitch angle, but at this moment he applied a nose-up input to the elevator in response to the decrease in pitch angle and the steep descent of the aircraft.
- 1115:37 The Mode 2 warning of the GPWS sounded "TERRAIN TERRAIN" once.
Computation of the CAS and AOA that had earlier paused, now resumed.

- 1115:40 The aural stall warning, which had stopped at 1115:27, sounded again and continued until impact.
- 1115:45 From the conditions in which the CVR and DFDR recordings ended, it was estimated that the aircraft crashed at approximately 1115:45.

3.1.2.2 Analysis of Flight Conditions

(1) Concerning activation of the GO lever

It is recognized that the F/O (P/F) triggered the GO lever at 1114:05 , judging from the following: the increase in engine thrust starting at 1114:05, as recorded on DFDR; the CAP's (PNF) utterance at 1114:06, the sound of LANDING CAPABILITY CHANGE at 1114:09, the CAP's caution at 1114:10, and the F/O's response at 1114:11, all of which were recorded on CVR.

The F/O activated the GO lever, causing the FD to change to GO AROUND mode, and the ATS to be engaged in THR mode.

It is considered that at 1114:06 the CAP said "EH. EH. AH," on seeing the display change on the FMA.

The F/O (PF) seems to have used ATS with his hand on the thrust levers, judging from the smooth transitions of both thrust levers recorded on DFDR until then.

It is considered that the F/O may have mistaken the GO lever for the AT disconnect push button in an attempt to change the ATS into manual thrust, or that he tried to move the thrust levers to control the thrust and thereby inadvertently triggered the GO lever. The reasons why are not clear, but, at any rate, he inadvertently triggered the GO lever.

The GO lever of the A300-600R type aircraft is positioned below the thrust lever knob. The direction that the GO lever is operated in is the same as the direction in which the thrust lever is retarded, or as the same direction that the fingers move when gripping the thrust lever knob. With this arrangement, the possibility exists for an inadvertent activation of the GO lever during normal operation of the thrust levers (See attached Photograph 51).

(2) Concerning CAP's direction at 1114:12

The CAP gave an instruction to the F/O, saying "Disengage it". The definite meaning of the word "it" is not found in the CVR records, but there seem to be two possible meanings - - "Auto Throttle" and "GO AROUND mode" -- which it could represent. This is inferred from the following:

The DFDR records show that activation of GO lever led to a thrust increase; the EPRs stopped at the value of 1.21 at 1114:08. It is considered that the F/O probably pushed the AT disconnect push button while holding the thrust levers -- which were moving forwards at the time -- and then retarded the thrust levers.

After this action the EPRs were reduced slightly. It seems that before 1114:12 the Auto Throttle had already been disengaged by the F/O, and the FMA display had

changed to “GO AROUND”.

It was most likely that the CAP's instruction in this situation meant that GO AROUND mode should be disengaged, because he must have seen the FMA display.

(3) Concerning the CAP's word at 1114:16

At 1114:16, the CAP said “That”, and the F/O said “ Ay”. The precise meaning of the word “that” is not found in the CVR records, but there appear to be three possibilities:

- ① The CAP instructed the F/O to engage the AP(s).
- ② Because the CAP's instruction at 1114:12 had not been followed, he repeated it.
- ③ The CAP's word did not represent an instruction, because the nuance is ambiguous. In this case, the F/O seemed to have given the CAP only a response.

However, it was not possible to determine which of the above scenarios is the correct one.

(4) Concerning use of AP

According to the DFDR records, both APs were engaged at 1114:18. Around this time, no verbal exchange as to AP engagement was recorded on CVR. However, there seem to be the following possibilities concerning engagement of APs:

- ① Possibility that the CAP instructed the F/O to engage the APs
If it is assumed that the CAP's word at 1114:16 meant the item (3)-① above, the F/O might have engaged the APs in accordance with the CAP's instruction. According to the positions of the thrust levers (throttle resolver angles) recorded on DFDR from 1114:12 to around 1114:18 (which is recorded every 4 seconds with one second time gap between NO.1 and NO.2), the positions of the thrust levers varied slightly respectively, so taking into account the time allowance for the actions taken by the F/O, it is considered possible that the F/O tried to select the LAND mode at first, then once held the thrust levers after taking actions to change mode, and furthermore took action to engage the APs.
- ② Possibility that the CAP engaged the APs himself
If it is assumed that the CAP's words at 1114:16 meant item (3)-② or (3)-③ above, then the CAP is likely to have engaged the APs himself
- ③ Possibility that F/O engaged the APs himself
If it is assumed that the CAP's words at 1114:16 meant item (3)-② or (3)-③ above, another possibility is that the F/O engaged the APs without the CAP's consent, or without notifying the CAP. In this case, according to the CVR records, because the F/O had so far operated during the whole flight based on the CAP's instructions, or with the CAP's consent in advance, there seems to be a possibility that the F/O instinctively engaged APs for their assistance.

However, it was not possible to determine which of the above scenarios is the correct one.

The reason why either the CAP or the F/O engaged the APs may have been that the crew intended to regain the normal glide path by selecting LAND mode and engaging the APs.

(5) Concerning the operation of Pitch Trim Control Switch

The activation sound of the pitch trim control switch was recorded on CVR at 1114:20, 1114:34, and 1114:39 respectively. If a hypothesis is made that the F/O knew that THS trimming operated by the pitch trim control switch was inhibited during AP engagement, the CAP may therefore have engaged the APs unknown to the F/O. However, from the fact that the F/O actually disengaged both APs at 1114:49, he may finally have recognized that the APs had been engaged by this time.

On the other hand, even though the F/O may have recognized AP engagement, it is still possible that he may have involuntarily operated the switch while pushing the control wheel.

(6) Concerning disengagement of GO AROUND mode

The CAP said “You, you triggered the GO lever” at 1114:10, and alerted the F/O (at 1114:30 and 1114:45) to the fact that GO AROUND mode had been engaged. This leads to the possibility that after the F/O had triggered the GO lever, the CAP, watching the FMA display, intended to disengage GO AROUND mode and instructed the F/O to do so. However, it is inferred from the following facts that GO AROUND mode remained engaged.

- ① THS moved in the direction opposite to the F/O's input at the control wheel.
- ② Disengagement of GO AROUND mode and engagement of other modes led AP No.2 to be disconnected, but no data concerning this was recorded on DFDR.
- ③ CAP continued until 1114:45 to alert the F/O to the fact that GO AROUND mode was still engaged.

In order to disengage GO AROUND mode, both lateral mode and longitudinal mode (except LAND mode) must be selected. Direct access to the LAND mode button cannot disengage GO AROUND mode (by selection of either lateral or longitudinal mode a display of GO AROUND on FMA will turn off).

However, judging that GO AROUND mode still remained engaged, it is estimated that what the crew's operation on FCU was not correct procedure to disengage it : he must only have pulled LAND mode button. And also, taking into account that the CAP said “I, that LAND mode ?” at 1114:58, the CAP seemed to have intended to disengage the GO AROUND mode and select LAND mode.

The procedure for performing an approach by disengaging GO AROUND mode once engaged and then engaging LAND mode is unusual in the final phase of approach. However, the fact that the crew did not change modes as intended seems to have been due to their lack of understanding of the Automatic Flight System (AFS).

(7) Concerning the sequence leading up to the out-of-trim situation

After the GO lever was triggered, the sequence leading up to the out-of-trim situation was as follows:

① Just before 1114:05

In the landing configuration with landing gear down and SLATS/FLAPS at 30/40, the aircraft continued descent along 3° ILS glide path with a speed of approx. 140 kts., pitch angle of approx. 4°, both EPR at approx. 1.1, THS at -5.3°, and the elevator angle (relative to THS) at 0° to 1° nose down.

② Just after 1114:05

While crossing approx. 1,070 ft pressure altitude, the GO lever was activated by the F/O, and when the EPRs increased to 1.21 at about 14:08, the thrust levers were manually pulled back slightly.

The aircraft increased its speed and pitch angle slightly, deviating above the ILS glide path. The F/O applied push-down input to the control wheel but it was insufficient and also he did not retard the thrust levers sufficiently. These circumstances led the aircraft to level off about 1,040ft pressure altitude around 1114:10. For a while the THS had stayed at -5.3°. And pitch trim control switch was not operated.

③ 1114:18

While the aircraft continued level flight, both APs were engaged in CMD with the FD already in GO AROUND mode, and the APs, were brought into GO AROUND mode.

In the meantime, the F/O (PF) had been pushing the control wheel since 14:05, when he had activated the GO lever, in an effort to return to the normal descent path.

At the time when the APs were engaged in CMD, the elevator angle was 3.5° nose-down. The angle decreased to 2.8°~2.4° temporarily in the period between 1114:19 and 1114:20, but the nose-down angle gradually increased thereafter.

GO AROUND mode was engaged while the F/O was pushing the control wheel. The AP attempted to move the elevators and THS toward the nose-up direction, but this resulted in the elevators' function being overridden and the THS beginning to move in the nose-up direction from -5.3°.

However, the nose-down operation of the elevators performed by the F/O canceled the aerodynamic effect of the THS nose-up which was controlled by the AP, and the aircraft temporarily continued level flight. The surface area of THS (including the elevators) is approximately three times that of the elevators. The aerodynamic effect per unit travel angle of the THS is therefore considerably greater than that of the elevators.

④ 1114:24

To correct the descent path, the F/O (PF) began to retard the thrust levers and reduced the EPRs from approx. 1.17 to approx. 1.00 by 1114:31.

As a result, the speed began to decrease from 146 kts., causing the nose-up tendency also to decrease. This retard operation of the thrust levers and the push-down operation of the control wheel by the F/O against the movement of the THS in nose-up direction, together caused the pitch angle to decrease, and the aircraft began to descend around 14:26.

⑤ 1114:30

The pitch angle which had decreased to 1.2° again began to increase .

This is considered to be due to the fact that the pitch-up effect generated by the nose-up movement of the THS became larger than the pitch-down effect brought about by the push-down operation of the control wheel from that time on.

The speed continued to decrease slowly. As the pitch angle increased, the AOA also began to increase.

⑥ 1114:37

While crossing approx. 880 ft pressure altitude, the THS reached the full nose-up position of -12.3°, and the elevator was moved to 8.5° in the nose-down direction. Around this time, the descent rate was approximately 1,000 ft/min.

Although the control wheel was still being pushed, the pitch angle and AOA continued to increase, while the speed continued to decrease. In order to deal with the continuous decrease in speed, the F/O increased the thrust slightly.

⑦ 1114:49

While crossing approx. 700 ft pressure altitude, the APs were disengaged, but THS remained -12.3°, and out-of-trim condition continued.

(8) Concerning activation of Alpha Floor Function (Refer to 3.1.11.6)

Just after the APs were disengaged at 1114:49, the mobility of the control wheel (being pushed by the F/O(PF)) increased a little, thereby moving elevators in the nose-down direction; and pitch angle and AOA decreased. A few seconds later, forward pressure on the control wheel was loosened a little, and pitch angle and AOA increased again. When the aircraft crossed approximately 570 ft pressure altitude at 14:57, as airspeed was 127 kts., both EPRs were 1.04 and pitch angle was 8.6° and AOA exceeded threshold angle of 11.5° for the configuration of SLATS/FLAPS 30/40, the alpha floor function was activated.

Although at this point of time, THS was -12.3° and the elevator angle was 9.9°, the sudden increase of power due to the out-of-trim condition and the activation of the alpha floor function generated a pitch up moment. As for the fact that the F/O (PF) loosened forward pressure on the control wheel a little several seconds after AP was disengaged, it is considered likely that he did so in order to correct the pitch angle. However, even if the F/O (PF) had not loosened forward pressure on the control wheel at this point of time, the AOA, sooner or later, must have been exceeded threshold angle of 11.5° due to the trend of speed,

pitch angle and the AOA if the aircraft had continued to approach under the above-mentioned out-of-trim condition.

(9) Concerning continued approach

The CAP (PNF) had had the F/O perform the PF duty while making an ILS approach. Judging that although the aircraft once deviated above the glide path after the F/O triggered the Go lever, it began to return to the normal glide path due to the F/O's fully forward pressure on the control wheel and reducing the thrust following the CAP's instruction, and the runway was visible to the crew due to good weather condition and sufficient visibility, the CAP probably intended to have the F/O continue the approach. It is considered that the CAP paid his attention outside to assess the aircraft position and the descent flight path from the view of the runway and the CAP would have instructed the F/O only to have the aircraft recover the normal glide path.

(10) Concerning override of the AP

The CAP (PNF) instructed the F/O (PF) repeatedly to push the control wheel. There seem to be the following possibilities as to why he did so:

- ① The CAP did not recognize that the APs were engaged.
- ② The CAP recognized that the APs were engaged, but he believed that the F/O had disengaged GO AROUND mode either when the CAP instructed him to do so or when he had pointed out that GO AROUND was still engaged.
- ③ The CAP recognized that the APs were engaged, but he thought that he could manually override the AP, based on his flight experience of B747-200 and 400 aircraft.

The aircraft incorporates a supervisory override function which allows pilots to assist the AP by applying a force on the control wheel when capturing the Glide Slope, the Localizer or the VOR course. There seems to be a possibility that the crew's experience in using this function led to their mistaken belief that they could override the APs during all phases of approach. This could have led them to override the APs while in GO AROUND mode.

The hazard of overriding the elevator by operating the control wheel while the APs are engaged in GO AROUND mode is described as a "CAUTION" in the FCOM. The reason why the crew took actions which nevertheless resulted in an out-of-trim condition, is presumed to be that they had not properly understood the contents of these cautions, and of other related descriptions in the FCOM. As mentioned later, the fact that descriptions in the FCOM are not easy for pilots to understand, and functions to alert pilots of THS movement are not properly incorporated, probably affected this outcome as a background factor (Refer to 3.1.11.3 and 3.1.11).

(11) Concerning the CAP's remarks at 1114:58

At 14:58, CAP (PNF) said, "I, that LAND mode?". This may be interpreted as follows:

- ① At 14:12, CAP (PNF) instructed the F/O (PF), saying, "Disengage it."
(Disengagement of GO AROUND mode was very likely).
- ② Twice after this, the CAP (PNF) cautioned the F/O (PF) that GO AROUND mode was still engaged.
- ③ CAP instructed the F/O (PF) repeatedly to push the control wheel.
It is considered likely that the CAP said "I, that LAND mode?" in puzzlement on realizing that the aircraft was still not adopting the proper attitude for descent, in spite of his above-mentioned instructions and cautions.

(12) Concerning timing of control take-over

After the APs had been engaged, the F/O attempted to recover the normal descent path, but could not maintain airspeed and aircraft altitude to do so.

To deal with this situation, the F/O (PF) disengaged both APs at 14:49, saying "Sir, auto pilot disengaged."

At 14:51, the F/O (PF) reported to the CAP (PNF), saying "Sir, I still cannot push it down, yeah", probably because the pitch angle was still high, and the aircraft was still not responding to his actions. Again at 15:02, the F/O (PF) reported, saying "Sir, throttle latched again."

Until then, the CAP (PNF) appears not to have fully grasped the flight situation. Hearing the F/O's (PF) report above, the CAP (PNF) seems to have decided to take over the controls to deal with the unusual situation. At 15:03, CAP took over the controls.

However, even at this point, the CAP (PF) still seems to have been unaware that the THS was at the nose-up limit.

Although the CAP (PNF) would have been unable to experience directly the unusually strong resistive force of the control wheel until he took the controls, in view of the points described below, he could still have recognized to some extent that an abnormal flight condition had arisen.

- ① GO-AROUND mode continued to be displayed on the FMA.
- ② The CAP had earlier instructed the F/O to push the control wheel and retard the thrust levers in order to regain the normal glide path. However, the aircraft did not respond as the CAP had intended when he issued his instructions.
- ③ The CAP had had to give directions and cautions (such as item ② above) to the F/O, one after another. This fact itself suggests that the F/O must no longer have been in a condition to perform PF duty adequately.

However, it is considered that the CAP's situational awareness as PIC for the flight was inadequate, control take-over was delayed, and appropriate actions were not taken.

(13) Concerning GO AROUND after CAP took over controls

Immediately after the CAP took over the controls, he retarded the thrust levers to reduce the power before calling "GO lever" at 15:11.

It is considered that when CAP took control, although he was aware of an unusually strong resistive force on the control wheel, he still intended to make a landing; so he pulled the thrust levers to try to reduce the pitch angle which was increasing. However, judging that the CAP was unable to stop the pitch angle (which was increasing in nose-up direction), it is estimated that he gave up landing, uttering "How come like this?", decided to go around and then called out "GO LEVER" while increasing the thrust, which had earlier been reduced, to full thrust.

In normal go-around procedure, PF calls "go around flap" as he operates the GO lever, PNF moves the SLATS/FLAPS lever one step up, and after calling "positive climb" PNF performs a gear up operation following PF's order.

In this case, however, the correct procedure was not followed as stated. After "GO lever" was called, it took about seven (7) seconds before initial movement of the SLATS/FLAPS lever in the retract direction took place.

While the SLATS/FLAPS lever should be moved from 30/40 to 15/20, from the CVR record it is considered possible that the lever was moved to 15/0 or even higher, to the 0/0, before being lowered again to the 15/15 position. The landing gears were left in the down position (See attached Figure 27.).

(14) Concerning operations performed to deal with increasing pitch angle and steep climb

① 1114:57

In a pitch-up side out-of-trim condition with the THS at -12.3° and the elevators at 9.9° , the alpha floor function was activated, suddenly increasing the thrust and which caused a large pitch-up moment to be generated.

② 1115:03

The pitch angle did not stop increasing despite the CAP's (PF) efforts who, after taking the controls, pushed the control wheel to the forward limit and retarded the thrust levers.

Around 15:04, the aircraft which had, until that point, been descending, began to climb from approx. 500 ft pressure altitude (approx. 360 ft radio altitude).

③ 1115:11

When the CAP(PF) increased the thrust again and called, "GO lever", the aircraft was climbing through approx. 600 ft pressure altitude with pitch angle at 21.5° .

The pitch angle was further increased by a large pitch-up moment generated by the increase of thrust under the pitch-up side out-of-trim condition.

Speed began to decrease from 137 kt around 15:08.

④ 1115:12

It is considered that the CAP (PF) continued to push the control wheel fully to reduce the pitch angle, and intermittently operated the pitch trim control switch in the pitch down direction, as indicated by the slow return of the THS from the limit angle of -12.3° to -10.9° by 15:19. (Intermittent use of the switch does not generate the “Whooler” tone.)

Thereafter, the THS moved again from -10.9° at 15:21 to -7.4° at 15:27. It is considered possible that the alpha trim function activated because the AOA at 15:23 was approx. 18°, which exceeded the threshold angle of 17° for SLATS/FLAPS 15/20 and 15/15 configurations.

It was not determined whether or not the manual trim had been operated during the above period.

During the period from 15:27 to 15:33, the THS remained at -7.4°.

The CAP (PF) operated the pitch-trim only intermittently during the go around. Consequently, it is considered that he was not aware of the THS state.

⑤ 1115:20

There are three feasible ways to reduce increasing pitch angle: to push the control wheel, to regain trim, and to reduce the thrust. Under the conditions of steep climb and continued decrease of speed, it seems that the CAP(PF) hesitated to reduce the thrust.

However, at this point of time, when the speed had decreased to 115 kts., the pitch angle had increased to an abnormal 40.3°, it is considered that the CAP (PF) retarded the thrust levers to reduce pitch angle.

At approximately 15:23 No.1 thrust lever was retarded to a position near idle and No.2 thrust lever was retarded slightly. This is probably because, although the CAP was hastily attempting to retard the thrust levers in an effort to correct the aircraft attitude which continued to climb steeply, the CAP's (PF) hand came off the thrust levers at the above-mentioned position while continuing to push the control wheel with the aircraft's steep nose-up attitude.

Around 14:27, the thrust levers were moved to a position close to full thrust. This seemed to result from the fact that either the CAP or the F/O pushed the thrust levers forward in an attempt to recover lost speed.

It is also presumed that the aircraft's nose-up pitching moment was further increased as a result of the SLATS/FLAPS retracting from 30/40 to 15/15.

(15) Concerning crew coordination between the CAP and the F/O (See Appendix 2-1)

① At 1059:04 and 1113:14, the CAP (PNF) read out the approach checklist and the landing checklist at the request of the F/O (PF), but these were not performed in the proper manner because the CAP (PNF) read the items only to himself, including those to which the CAP and F/O (PF) should responded together.

② At 1114:18, both APs were engaged, but nothing was said that expressed definite

instructions or intentions to make the F/O (PF) change mode or engage the APs. The CAP's words when instructing the F/O to disengage GO AROUND mode were only "Disengage it". These words did not describe a definite operation.

- ③ At 1114:12, the CAP said, "Disengage it." At 14:30, he said, "You, you are using the GO AROUND mode." At 14:45, he said, "It's now in the go around mode." By these words, the CAP pointed out the current mode and instructed the F/O to change the mode.

In response to this, it seems that the F/O took some action to change modes, but was unable to successfully engage LAND mode in the end. In this case, the F/O did not immediately report to the CAP (PNF) that he could not change modes (or that did not know how to change modes).

In the meantime, after the CAP pointed out the current mode and instructed the F/O to change modes, it is considered that the CAP did not check the FMA display properly on each occasion to see whether the mode had actually changed or not.

- ④ When the F/O was instructed by the CAP ("Push more.") he did not report the abnormally strong resistive force of the control wheel to the CAP. As a result, it is probable that the CAP was not fully aware of the situation and that his instructions to the F/O were therefore inadequate.

The F/O must have perceived the abnormally strong resistive force of the control wheel, but he, who was under high stress from the following factors, probably delayed reporting the situation properly to the CAP:

- The F/O had been instructed to control the aircraft at his own discretion, for as long as he could.
- He had inadvertently triggered the GO lever.
The CAP had pointed out to the above actions to the F/O. Subsequently the CAP had given a series of instructions and cautions to the F/O about control and operation of the aircraft, one after another.
- The F/O was so busy following the CAP's instructions and cautions, thereby losing his initiative as PF, that he had almost no room left to take the appropriate measures by himself.

- ⑤ During approach, the CAP had instructed the F/O to perform PF duty, but after the F/O triggered the GO lever, the CAP gave a series of instructions and cautions to the F/O about control and operation of the aircraft, one after another. As a result the CAP made the F/O lose his autonomy and disregard their duty assignment, namely, that the CAP was the PNF and the F/O was PF.

- ⑥ The FCOM 2.03.18 (page 3) stipulates under the title of "STANDARD OPERATING PROCEDURES - STANDARD/APPROACH" that if the speed exceeds VAPP +10 Kts. or becomes less than VAPP -5 Kts. , or if the aircraft deviates a dot or more from the glide slope during an approach, the PNF should call out the fact.

At 1114:17, the aircraft deviated more than a dot upward from the glide slope, and speed decreased to less than -5 Kts. from the VAPP of 140 KCAS as the aircraft continued approach. Despite this, the CAP did not call out these facts as PNF.

(16) Concerning the tones of MASTER CAUTION record on CVR.

There is a possibility that audible tones of MASTER CAUTION (SINGLE CHIME) recorded on CVR at 1115:23, 15:28 and 15:31 were set off respectively by the tripping of the yaw damper levers, pitch trim levers and ATS lever.

These CAUTIONs were triggered because the input sensor data were judged as "INVALID" and the systems relating to the above mentioned levers were disconnected.

Because the aircraft's attitude and speed changed rapidly during this phase of the flight, the possibility that the MASTER CAUTIONs were generated by a different cause cannot be ruled out.

However, if the conditions on which these CAUTIONs sounded, the relations among these occurrences around the time when they sounded, and the analysis of the sound spectrum of the CVR recordings are considered together, it would be highly possible that these CAUTIONs are the same as the ones described at each of the times in paragraph 3.1.2.1.

3.1.3 Estimation of crash time

As described in 3.1.1, it is estimated that the CVR and DFDR stopped recording around 1115:45. This was probably caused by the breaking of cables on impact. The time of the crash is estimated to be around 1115:45 (when the CVR and DFDR stopped recording).

3.1.4 Attitude of Aircraft at the Time of Crash and Damage to Aircraft

3.1.4.1 Attitude of Aircraft at the Time of Impact

From the DFDR records, it is estimated that the aircraft stalled, then descended steeply with wildly changing roll angle, and impacted the ground.

The spot where the aircraft hit the ground was an unpaved, flat landing area. There were marks left on the ground surface that clearly identified those portions of the aircraft which had hit the ground. From the shapes of the marks and these positional relationships as well as the condition of destroyed landing gears, it is inferred that on impact, the aircraft was in a somewhat left-wing down, nose-up attitude, and was in an almost level attitude.

3.1.4.2 Investigation of Broken Landing Gears

The broken nose and main landing gear were investigated in order to analyze the conditions of the landing gear, the aircraft attitude, and other associated conditions of the aircraft at the

time of the crash.

All of the broken landing gears had signs of compressed oleo struts with buckled cylinders, which implies that the gears received an upward thrust, and so that the aircraft had impacted the ground with all landing gears extended.

The rear bogey beam of the LH main gear, which presumably touched the ground first, was sheared off in a ring shape at a relatively thin portion beside the strut attaching part. The rear inner wheel (with tire still inflated) of the LH main gear and the accompanying brake assembly, were flung away furthest to a point approximately 190 meters from the point of impact. It seems that this occurred because of a rupture that occurred at the moment of impact, when the kinetic energy was greatest and its loss was minimum, and also by a high rebound force brought about by the tire.

The damage to the two (2) front tires of the LH main gear was extensive, with outer tires burnt and inner tire burst owing to impact. An assumption from these conditions is that breakage occurred at the front and rear of the bogey beam, with subsequent impact transmitted directly from the ground to the strut. The direction of lacerations on the tires suggested that they skidded to the right.

3.1.4.3 Crash Circumstances and Damage to Aircraft

The crash process from when the aircraft first hit the ground to when it was destroyed is estimated to be as follows:

- ① The LH main gear of the aircraft impacted the ground first, and at this point of time, there were no other parts in contact with the ground.
Compared with the wheelbase of the aircraft, the measurement between the scars on the ground was greater. This implies that the aircraft was moving forward in a slightly nose-up attitude.
At this point in time, the aircraft's magnetic heading was approximately 15 degrees (015°) and its side-skid angle was approximately seven degrees (7°) to the right, judging from the aircraft's attitude, that was almost level, and the direction of motion of the aircraft deduced from the marks left on the ground.
Since the LH main gear impacted the ground first, the aircraft's began to turn counter-clockwise as viewed from above.
- ② The RH main gear impacted the ground a little later than the LH main gear.
The fact that the ground scars of both main gears were not long in comparison with the track of the wheels suggests that the aircraft was descending at a steep flight path angle.
The pitch angle at this time was approximately four degrees (4°) nose-up, as calculated from the geometrical characteristics of the aircraft, the conditions of the broken LH main gear, and the position of the nose gear.
- ③ At the moment the LH engine impacted the ground (receiving the strongest shock), the RH

engine was beginning to receive the impact from the ground. Both the main gears were being destroyed in that while.

The roll angle at this time was approximately three degrees (3°) to the left as determined from the positions of both main gears, nose gear, and LH engine.

- ④ By the time the nose landing gear impacted the ground, and was under maximum shock, both main gears had already been destroyed and the LH engine was in the process of destruction.
- ⑤ At the above point in time, the LH wing-tip also hit the ground. Judging from the positions where the marks of the LH wing tip and RH engine were found, all the landing gears were destroyed and the bottom of fuselage started breaking. The aircraft received an additional counter-clockwise moment after touching the ground and the entire airframe was distorted. The recovered LH wing-tip had a deformation showing an impact it had received from contact with the ground at its lower, slightly inboard section. On the other hand, the LH wing tip was damaged on its upper part, indicating that it was damaged when the RH wing was destroyed.
- ⑥ After the LH wing-tip had been destroyed, the LH flap track touched the ground. Destruction of the fuselage progressed to the lower part of the floor, and shortly afterwards, the horizontal stabilizer was flung onto the ground almost in a level attitude. The direction of the scratch marks left on the lower access panel of the THS corresponds roughly to the direction in which the debris were strewn (22 degrees (022°) in magnetic heading).

From extrapolation using the DFDR records, the trajectory angle at the time of impact was estimated to be approximately 32°.

3.1.4.4 Condition of Wreckage

After the aircraft had impacted against the ground, the major parts of the wreckage are estimated to have been in the conditions described below.

From the scattered condition of wreckage, it is estimated that the momentum vector of the aircraft in the level plane when it crashed was approximately 22 degrees (022°) from magnetic north and approximately 42 degrees (42°) to the right of the centerline of the runway 34.

- ① The LH engine, having dropped from the wing pylon, tumbled forward; the lower skin of the aft fuselage remained in the vicinity of the spot where it had first contacted the ground, and the horizontal tail plane and APU compartment were ruptured and had separated.
- ② The outer flap, center flap, and outer wing of the LH wing were ruptured and had separated from the wing.

- ③ The outer flap, center flap, inner flap, spoiler, outer wing and other components on the RH wing were ruptured and had separated from the wing, and were strewn as far as the irrigation ditch.
- ④ The upper portions of the forward and aft fuselage sections, along with the portion of wing that remained attached to them, tumbled to the vicinity of the irrigation ditch, together with the ruptured and separated vertical tail plane and upper portion of the aft fuselage, all in broken state.
- ⑤ The cargo loaded on board was scattered in the area between the spot where the aircraft hit the ground and the vicinity of the irrigation ditch, and almost all ruptured seats were found near the irrigation ditch.
- ⑥ The fuel that had leaked from the broken LH wing when the aircraft crashed into the ground splashed over the area from the vicinity of the spot where the LH wing first hit the ground to where the center of the wing had come to rest, and fuel from the RH wing was scattered widely, together with debris of the RH wing, as far as the vicinity of the irrigation ditch.

It is estimated that among the wreckage strewn forward, by the forward-acting inertial force generated when the aircraft crashed, were items such as the fuselage section aft of the central wing section, functional components, cabin furnishings, seats, and cargo burned when the fuel ignited, and were destroyed by expanding fire.

3.1.5 Investigation of Engines and FADEC

Investigation of the dismantled engines revealed that damage to components of both engines were indicative of their rapid destruction. Rotors blades were torn and deformed in the direction opposite to that of rotation. All these conditions support the assumption that the engines had been running at high speed until the aircraft crashed.

The data recorded in all the channels of both FADECs show that surges occurred in both engines, indicating a sudden drop of combustion chamber pressure during the flight.

Also, engine data recorded by the DFDR show that the engine pressure ratio, fuel flow rate, and high-pressure shaft rotating speed dropped for short periods at 1115:31 for the No.1 engine and at 1115:32 for the No.2 engine, to values lower than those that should normally result in response to the thrust lever operation performed. This could have been due to the FADEC counteracting the engine surge. Subsequently these engine parameters returned rapidly to values that normally correspond to the thrust lever movements, and no abnormalities caused by surges of the engines were subsequently detected.

When engine surging occurs, flames sometimes shoot out from the front and rear of the engines. Both engines may therefore have emitted light as the aircraft fell into an abnormal

condition during stall.

It is estimated that the engine surge which occurred when the aircraft fell into a stall condition was due to a phenomenon called “inlet distortion” in which uniform air flow through the engine air inlets is not available owing to a high AOA.

It is estimated that the AOA at this point of time was far greater than the range for normal operation, exceeding the engine air intake airflow angle limit permitted for the aircraft.

3.1.6 Results of Investigation of Computers and Other Equipment

3.1.6.1 Computer Memories

The memories of one FAC, one FMC, one SGU-EFIS, two SGU-ECAMs, one FWC, two ADCs, three IRUs, two GCUs, and one ILS receiver could be read out, but there nothing was recorded that might have been of relevance to the accident.

3.1.6.2 Investigation of Disassembled Components and Others

Of the components recovered from the crash site, 54 items (128 Units) including the AP pitch actuator, elevator actuators, trim actuator gear box, and center pedestal and so on, were analyzed by means of disassembly and other methods. Nothing abnormal was found except the damage inflicted at the time of the accident.

3.1.6.3 IRS Mode Selectors

As shown in 2.15.2, IRS mode selector No. 3 was in the NAV position, while the No. 1 and No. 2 selectors were in the OFF and ATT positions, respectively. The IRS is an essential system for engaging the APs, and the DFDR records indicate that both AP No. 1 and No.2 were engaged. Also after that, the CVR records did not contain any data that suggests failure of the IRSs, and further, there were no evidence showing changeover of the selector in the Left side Instrument Switchings record. These facts imply that the No. 1 and No. 2 IRS mode selectors were moved by the impact at the time of ground impact, or later.

3.1.6.4 SLATS/FLAPS Positions and THS Angle

(1) SLATS/FLAPS positions

By comparing the screw jack nut positions of the SLATS/FLAPS actuators of an aircraft of the same type with those of the crashed aircraft, the nuts of the crashed aircraft were to be at the positions corresponding to 15/15.

These positions are almost in agreement with the last SLATS/FLAPS angles of 17.05°/8.25° (15/15 position) recorded on the DFDR.

Also, the shaft of the broken SLATS/FLAPS command sensor unit was found seized up at the

15/15 position.

Judging from the above findings, it seems that the SLATS/FLAPS lever position of 15/20 shown in paragraph(2), Section 2.15.2, was a result of a movement that might have occurred as a result of impact, or some time afterward.

(2) THS angle

The THS angle was determined to have been approximately -8° , as a result of a comparison made between the THS screw jack nut position of the crashed aircraft and that of an aircraft of the same type. This angle roughly agrees with the last THS angle of -7.4° recorded on the DFDR.

It was also found that the pitch trim control cable system was broken.

The conclusion from the above is that the THS position indicator reading of -9.4° / -9.5° shown in paragraph(2), Section 2.15.2, is a result of a movement in the indicator that might have occurred at impact or thereafter.

3.1.7 Seated Positions of CAP and F/O

3.1.7.1 Analysis Based on CVR Records

- (1) Analysis of data recorded on channels 2 and 3 of the CVR, could not determine where the CAP and F/O had been seated, since the voices and sound records, including radio communications on channel 2 (on the F/O's seat side) are exactly the same as that on channel 3 (on CAP's seat side), owing to the cockpit intercom communication system.
- (2) From the record of the CAP's call out, "SHOULDER HARNESSSES" (1100:05), to confirm the wearing of the shoulder harnesses as he read the approach checklist, the record of the F/O's response, "FASTEN RIGHT", and the record of the CAP's confirmation of approach check list completion, "OK, FASTEN LEFT, APPROACH CHECKLIST COMPLETED" (1105:05), on the CVR, it is estimated that the CAP was seated in the left seat and the F/O in the right seat.
- (3) From the conversation between the CAP and F/O, recorded on CVR, about control of a light, it is recognized that the CAP was adjusting a light (refer to attached Figure 23).

Of the adjustable lights, if the one that the CAP (PNF) was adjusting was the captain and center instrument light, or the main instrument panel flood light, it is considered that the CAP was seated in the left seat (the adjusting knobs of these lights are located at the left end of the instrument panel, on the same side as the left-hand seat).

However, if the light which the CAP (PNF) was controlling was either the glare shield light, pedestal and overhead panel light, or the dome light, the adjusting knobs of these lights could be operated from either the right or left seat.

As inferred from the above, it is therefore not possible to determine which seat the CAP was occupying.

3.1.7.2 Analysis Based on Wreckage of Seats (See attached Figures 24 and 25)

- (1) The recovered seat wreckage had damage marks caused at the time of the ground impact. Analysis of the seat-setting positions from these marks is as follows: for the left seat (CAP's seat), the vertical position was set approx. 70 mm above the lowest position, and its longitudinal position was near the foremost position, whereas for the right seat (F/O's seat), the vertical position was set approx. 30 mm above the lowest position, and the longitudinal position was set approx. 33 mm rearward from the foremost position. As inferred from these settings, the right seat was set approx. 40 mm lower than, and approx. 33 mm rearward of the left seat. Since the crew positions are adjusted by means of an eye locator, such that the eye levels of both the right and left seat occupants will be about equal, it is considered that the person in the right seat was taller than the one in the left seat.
- (2) According to the airman medical certificate, the CAP was 162.5cm tall and the F/O 178.1cm tall. From this data, and the damage marks to the seats discussed in (1), it is estimated that the CAP was in the left seat and the F/O in the right seat.

3.1.7.3 Seated Positions

From the implication of the CVR record concerning the wearing of the shoulder harnesses, and by comparison of the vertical and longitudinal positions of both seats estimated from the damage marks to the seat wreckage, as described in sections 3.1.7.1 and 3.1.7.2, it is considered that the CAP and the F/O were seated in their formal positions: the CAP in the left seat, and the F/O in the right seat.

3.1.8 Injury to Passengers and Seat Assignment (See attached Figure 26)

3.1.8.1

The number of survivors of this accident was seven (7), all being seriously injured. As noted in section 2.12.2, 16 passengers were taken to several hospitals by rescue workers.

- (1) Among passengers hospitalized, six (6) persons were found dead on arrival. The cause of death of four (4) of the six (6) was whole body contusion and fractures; the other two (2) died of whole body contusion and thermal injuries.

It is estimated that four out of the six (6) were seated in the forward section of the cabin and the other two (2) in the aft section.

- (2) Three (3) out of the (10) seriously injured passengers died on April 27, April 28, and May 1, respectively, at the hospitals to which they had been admitted. The cause of death of these three (3) was whole body contusion and fractures. The estimated seat assignment for two (2) of the three (3) was in the forward section of the cabin and one (1) in the aft section.

(3) The remaining seven (7) seriously injured were diagnosed as suffering from traumatism and various external injuries, primarily bone fractures.

All of these seven (7) passengers were seated in the forward section of the cabin, in front of the wings.

3.1.8.2

According to the post-mortem report, the cause of death of those passengers who died before hospitalization was determined to be whole body contusion, fractures, and thermal injuries.

The positions where the passengers suffering whole body contusion and fractures were seated extended over the whole cabin area, from the front to the rear of the cabin, while thermal injury was noted in many of the passengers who are estimated to have been seated behind the main wing where the fire started.

3.1.9 Detection of Ethanol in Remains of CAP and F/O

The remains of CAP, F/O, and purser were stored in the hangar after the accident, and underwent autopsies at different colleges. During the autopsies, samples were collected from the remains, and taken to the Scientific Investigation Labs of Aichi Prefectural Police Headquarters, where they were stored in refrigeration. On the following day, alcohol reaction tests were performed at the Labs. The results are summarized below.

	Time elapsed after death and before sample was taken	Sample	Ethanol concentration
CAP	Approx. 24 to 25 hours	Pleural fluid	13 mg/100 ml
F/O	Approx. 19 hours	Pleural fluid	55 mg/100 ml
Purser	Approx. 19 hours	Blood in heart	Not detected

Ethanol was detected in the samples from the remains of the CAP and the F/O, which is considered to be due to one or more of the following three causes.

It is also considered that two or three of the following causes were combined.

- (1) Post-mortem ethanol production
- (2) Alcohol ingestion before death
- (3) Mixture with alcoholic drinks on board

Each of the three causes were analyzed as described in the following sections.

3.1.9.1 Possibility of Post-Mortem Ethanol Production

According to legal medical documents, there are confirmed cases where ethanol has been

detected in the body of a person who never ingested any alcohol before death. It is understood that progress in decomposition of the body after death results in microbial fermentation, which produces ethanol.

There is a possibility that the ethanol detected in the remains of the CAP and the F/O was due to a post-mortem ethanol production for the following reasons:

- (1) The remains of the cockpit crew were stored in a hangar after the accident, and approximately 18 to 22 hours elapsed before they underwent autopsies. During this period, special measures, such as placing the remains in refrigerated storage, were not taken. The lowest and highest atmospheric temperatures at Nagoya Airport area during this period were approximately 10°C and 23°C, respectively. The temperatures in the hangar where the remains were kept is assumed to have been somewhat higher than the above-mentioned temperatures. Furthermore, it was noted that the remains of CAP and F/O had deep open wounds. In particular, the body of F/O was significantly damaged. The long time interval from occurrence of the accident to the autopsies, the environmental temperatures, and the existence of open wounds are considered to satisfy the conditions for post-mortem ethanol production.
- (2) The concentrations of ethanol detected in the bodies of the CAP and the F/O were 13 mg/100 ml and 55 mg/100 ml respectively; these concentrations are considered to be comparable with those normally detected as a result of post-mortem production.
- (3) Regarding the difference in concentration between the ethanol found in the body of the CAP and that in the body of the F/O, when the difference in temperature resulting from the difference in location within the same hangar and the difference in severity of open wounds between them are taken into account, the variation in concentration is considered to be within a conceivable range. On the other hand, ethanol was not detected in the purser's body which had a few open wounds.

3.1.9.2 Possibility of Alcoholic Ingestion before Death

Collected samples from the bodies of the CAP and the F/O in this case consisted only of pleural fluids, probably because damage to the bodies was extremely extensive. If the crew drank any alcohol before death, ethanol may have been detected in their pleural fluids (as ethanol in the blood is absorbed into other internal organs some time after alcohol is ingested). From the fact that the open wounds of the bodies of both the CAP and F/O were extensive, it is considered possible that blood became mixed with their pleural fluids.

If this is the case, the concentration of ethanol detected in the samples should be the concentration of ethanol produced post-mortem described in section 3.1.9.1 plus the concentration of ethanol resulting from alcoholic ingestion, but the possibility of alcohol ingestion before death and the extent thereof could not be determined.

3.1.9.3 Possibility of Mixture of Alcohol from Scattered Liquor Containers

Adjacent to the cockpit and behind the F/O's seat, a galley (No.1 galley, see attached Figure 26) was located in which liquors (about 40 bottles of whiskey and other liquors) were stored for passenger service. Also on board were bottles of alcoholic liquor carried by passengers.

It seems possible that destruction of the partition between the cockpit and galley by the impact caused liquors and other alcoholic drinks from broken bottles to be scattered over the bodies of the crew (who had open wounds). However, it could not be confirmed.

3.1.10 China Airlines' Operation and Training Rules and Handling of Service Bulletins

3.1.10.1 Operation

China Airlines has an Operations Policy Manual and an Air Crew Manning and Dispatch Manual that were prepared according to the requirements stipulated by the Taiwanese civil aviation authorities, and operate their aircraft in compliance with those manuals.

(1) Qualifications for Flight Crew

According to an Operations Policy Manual, the flight crew shall consist of personnel of good character, clear-cut features, and sufficient technical knowledge, and shall in addition satisfy the following conditions.

It is recognized that the CAP and F/O of the aircraft held valid licenses and satisfied the required number of hours' flight experience.

① CAP

- a. Shall have an ATR license (airline transport pilot license) and a type rating certificate issued by the Taiwanese civil aviation authorities and an airman worker card (identification card) issued by China Airlines.
- b. Shall have a valid airman medical certificate issued by the Aviation Medical Center.
- c. Shall have not less than 1,000 hours' flight experience with China Airlines.
- d. Shall have not less than 3,500 hours' flight experience overall.
- e. Shall have passed the captain training tests.

② F/O

- a. Shall have an SCP license (commercial pilot license) and a type rating certificate issued by the Taiwanese civil aviation authorities and an airman worker card (identification card) issued by China Airlines.
- b. Shall have a valid airman medical certificate issued by the Aviation Medical Center.
- c. Shall have passed the flight officer training tests.

(2) Requirements for Flying Aircraft by F/O in Revenue Flights

According to "AIR CREW MANNING AND DISPATCH MANUAL", requirements for

flying aircraft by F/O in revenue flights are stipulated as follows. (item ① through ④)

- ① China Airlines shall have F/Os fly a certain aircraft type in take-off and landing phases at least three times every three months to maintain their flying skills.
- ② When an F/O is to control an aircraft type in a revenue flight, the F/O shall be seated in the right seat.
- ③ When an F/O is to control an aircraft type in a revenue flight, the CAP shall strictly supervise the F/O's operation, shall assume all responsibilities for safety, and shall observe the following:
 - a. CAP shall have not less than 1,000 hours' flight experience on the aircraft type concerned.
 - b. The weather conditions at the origin and destination airports shall be VMC, the runway shall be in good and dry condition and be sufficiently long, and the cross wind velocity shall be not more than 15 kts.
 - c. Both take-off and landing weights shall be not more than 85 % of the maximum design weights of the aircraft type concerned.
 - d. When the F/O performs operations in critical phases of flight such as take-off climb, and approach and landing, the CAP shall always strictly supervise the operation and keep his hands and feet in position on the control wheel, rudder pedal, and thrust lever. In cases of an abnormal or emergency condition, the CAP shall immediately take controls and call, " I HAVE CONTROLS", and F/O shall call, "ROGER".
- ④ When flying, if 1) the weather conditions do not meet VMC criteria, 2) a fault occurs in the aircraft, 3) a clearance given by ATC is inappropriate, 4) the F/O carries out a procedure that exceeds the safety limits of the aircraft, or 5) if an emergency arises, the CAP, in the interest of safety, shall make a quick decision to take control.

It is recognized that items ①,② and ③-a,b and c above were satisfied in this case, i.e., that the F/O was flying the aircraft in revenue flight.

Considering item ③ above, whether the CAP kept his hands and feet in the appropriate positions during the approach and landing phases could not be determined. However, from the CVR record, it is recognized that he took over the controls to deal with the abnormal situation, saying "I have got it" at 1115:03.

Concerning item ④ above, as described in Paragraph 3.1.2.2.(12), it is considered that the CAP's judgment situational awareness was inadequate, and that he was delayed in taking over the controls.

(3) Utilization of Operation Technical Reports

China Airlines used the technical report on the incident of the A310 aircraft that had occurred on February 11, 1991 in Moscow for the training of the crew members concerned. However, there are no records indicating that they used the reports on other cases for training purposes.

The CAP and F/O involved in the accident did not attend the training that utilized the above technical report, as at the time they were not yet been assigned to A300-600R aircraft.

3.1.10.2 Training

(1) Training

China Airlines has established a training program according to the requirements stipulated by Taiwanese civil aviation authorities to conduct the following training courses in the classroom, simulator, and aircraft.

The CAP and F/O are recognized to have finished the training established by China Airlines. In the case of the A300-600R aircraft training program, the company basically employs the syllabus established by Airbus Industrie, the manufacturers of the aircraft, as their syllabus with the training standard times set themselves.

① New qualification acquisition training

Training performed to give experience, knowledge, and skill required for obtaining flight crew qualifications.

② Promotion training

Training performed to give experience, knowledge, and skill required for obtaining higher level flight crew qualifications.

③ Type transfer training

Training performed for flight crew who are to serve in an aircraft of a type different from the one in which they are currently serving or in which they served in the past to give experience, knowledge, and skill required for obtaining identical class flight crew qualifications.

④ Periodic training

Training performed periodically for flight crew to maintain and improve their knowledge and skill.

(2) Simulator training

① China Airlines did not have simulators for the A300-600R aircraft. Therefore, they conducted simulator training for the said aircraft type by using simulators owned by Thai International Airways of Thailand and Aeroformation of France (China Airlines contracted part of pilot training to Airbus Industrie, and Airbus Industrie subcontracted this to Aeroformation.).

② The CAP underwent simulator training for the A300-600 aircraft type in the Thai International Airways' simulator approved by the Thai aviation authorities. The F/O underwent this same training for the said aircraft type in the Aeroformation simulator approved by the French aviation authorities, and periodically in the Thai International Airways' simulator.

③ The simulator training manual used by China Airlines was prepared by Aeroformation of France. However, it had not been updated.

- ④ When the F/O underwent simulator training in October through November, 1992 in the Aeroformation simulator, a item of “ GO-AROUND DEMONSTRATE AP MISUSE IN GO-AROUND ” was included in its check sheet which the instructor used. A mark “+” was placed in the box indicating completion of the item. Airbus Industrie said that the item was added after the incident which had occurred in Moscow airport in February 1991. However a check sheet, which the F/O was previously given as a part of training materials by Aeroformation before training, was not yet revised and did not contain the above item. But how the F/O underwent training for the item could not be clarified. When the CAP underwent the training in June through July, 1992 in the Thai International Airways’ simulator, the check sheet, which China Airlines had obtained, was used. But this check sheet was not revised and did not contain the above item.
- ⑤ Concerning that Airbus Industrie did not provide China Airline with up-to-date training materials, it is considered that the agreement on dealing with up-to-date training materials was not made clearly between the two companies which had contracted the crew training.
- ⑥ According to French and Taiwanese persons concerned, the Thai International Airways' simulator does not simulate the AP overriding function in GO AROUND mode for the A300-600R aircraft's AP, but whether this had any bearing on the accident could not be determined.

(3) AFS Training

- ① The descriptions in FCOM for the AFS are not easy for crews to understand.
- ② The crew was not given sufficient technical information with regard to similar incidents.
- ③ Up-to-date training materials were not properly obtained.
- ④ CVR transcripts show that crew understanding of the AFS was probably not sufficient .

From the above items it is concluded that the training required to understand the sophisticated and complicated AFS was insufficient.

3.1.10.3 Handling of Service Bulletins

Service Bulletins (hereinafter referred to as "SBs") are issued by the manufacturers to notify each operator of the inspection and modification to aircraft and their equipment.

SBs are generally divided into four compliance categories: Mandatory, Recommended, Desirable, and Optional. Upon receipt of an SB, operators, referring to the compliance category described on the SB, determine whether or not it applies to their airplanes and, if so, how they should implement it.

Mandatory SBs are usually implemented on earliest possible occasion. If the SB is "Recommended" or any of the remaining categories, operators plan to implement it on the most suitable occasion, taking into consideration their operational experience, maintenance schedules, and type of operation.

In China Airlines, the Maintenance Headquarters first receive SBs, and then the engineers belonging to the Chief Engineer Office determine the way to implement each of the SBs as well as the applicable airplane numbers after evaluating and examining it. The determined results are entered in a form called TIPS (Technical Instruction Processing Sheet) which is then forwarded to the Department of Maintenance Control after being examined by the Department of Quality Assurance. The SBs are implemented under the supervision of the Department of Maintenance Control.

SB A300-22-6021 issued by Airbus Industrie dated June 24, 1993 with compliance "Recommended" specified, concerned a modification to the AFS, which disengages the AP when a force in excess of 15kgf is applied to the control wheel in pitch axis during a flight in the GO AROUND mode above radio altitude 400 ft (See appendix 2.).

To implement this SB, it was necessary to modify the two FCCs on each aircraft to which it applied.

According to China Airlines, the actions they took after receipt of the SB were as follows:

China Airlines received this SB on July 29, 1993. The SB B470AAM-22-007 of Sextant Avionique, the manufacturer of FCCs, which is specified in the Airbus SB, was issued on July 12, 1993. China Airlines, after receiving the Sextant's SB, issued on September 1, 1993, a TIPS (A300-6153) which contained instructions on handling of the Airbus SB.

Since the compliance category of the SB A300-22-6021 was "Recommended", China Airlines judged its implementation not urgent, and decided to carry out the modification at the time when FCCs needed repair.

As of August 1993, China Airlines possessed six (6) Airbus airplanes of the same type and the number of spare FCCs in stock was six (6). The number of the FCCs removed from the company as a result of failure, and sent for repair to Sextant Avionique Asia PTE Ltd. (hereinafter referred to as "Sextant Singapore"), was four (4) in 1991, eight (8) in 1992, and one (1) as of this time in 1993.

Since the maintenance facility of China Airlines was not sufficiently equipped for implementing the modification specified in the SB, China Airlines had to send their FCCs to Sextant Singapore which can carry out the modification. Consequently, China Airlines planned to carry out the modification at the same time as the repair of those FCCs removed owing to failure, while taking into consideration the time required for the modification as well as keeping spare FCCs necessary to maintain operations.

However, no FCCs were removed from China Airlines' aircraft as a result of failure, and sent to Sextant Singapore for repair in the period between June 24, 1993 when the SB was issued and April 26, 1994 when the accident occurred at Nagoya Airport.

According to Sextant Avionique, the implementation of the modification of FCCs had been arranged as follows:

The repair facilities of Sextant Avionique were located in France, America and Singapore.

The SB A300-22-6021 was not "Mandatory" when it was issued. The system to make an acceptance of the modification available was established in September, 1993. But it was in December, 1993 that Sextant Singapore started the modification job at the request of airlines.

Likewise, the Sextant's repair facilities in France and America started the modification of the FCC in April, 1994.

At the beginning as stated before, China Airlines adopted the SB A300-22-6021, but planned to accomplish the modifications at the time when FCCs needed repair (because the modification was not considered urgent). Since no FCCs had been sent to Sextant Singapore for repair before the Nagoya accident, the modifications in accordance with the SB A300-22-6021 were not made.

3.1.11 Automatic Flight System (See Appendix 1)

3.1.11.1 Pitch control system

Concerning the A300-600, it was possible for a pilot to override the elevators while the AP was controlling the THS in GO AROUND mode and LAND mode. Therefore, two control inputs for two different objectives could be allowed simultaneously in the pitch axis. The aircraft was not equipped with a warning device which would alert the pilot to two simultaneous control inputs. Such a design might have contributed to the accident as one of the factors of the abnormal out-of-trim.

3.1.11.2 AFS Operation

In order to verify the status of the THS, a computer simulation was conducted to demonstrate THS movement using the recorded parameters in DFDR such as airspeed, attitude, etc. The analysis revealed that the calculated THS movement history showed good correlation with the recorded THS data. From the analysis, it is recognized that FAC and FCC were functioning normally per design concerning with THS movement.

3.1.11.3 Modification to AFS (See Appendix 3 and 4)

- (1) With regard to the A300-600 aircraft incident of March 1, 1985 that involved an out-of-trim condition triggered by the switching of AP mode to ALT HOLD mode, Airbus Industrie established Mod.7187 in order to prevent the recurrence of similar incidents, and on March 18, 1988 it was approved by DGAC.

The Mod. 7187 was to add a function to allow AP disengagement by applying a 15Kgf force on the control wheel in pitch axis in modes except LAND track (below 400ft radio altitude) and GO AROUND mode.

After that, Mod. 7187 was included in SB A300-22-6009 dated June 1, 1989, but the SB did not contain any mention of the Mod.7187.

After that, in view of further incidents which involving out-of-trim conditions triggered by AP mode switching to GO AROUND mode -- on the A300-B4-203FF aircraft at Helsinki Airport on January 9, 1989 and on the A310 aircraft at Moscow Airport on February 11, 1991 -- Airbus Industrie issued SB A300-22-6021 dated June 24, 1993 which recommended operators to accomplish a modification to the AFS, as a measure against recurrence of similar incidents, namely to introduce a function that disengages the AP when a force greater than 15kgf is applied on the control wheel in pitch axis at a radio altitude higher than 400 ft in GO AROUND mode.
- (2) Although the causes which triggered the above incidents are different, all the incidents were similar in that the operation of the control wheel by the crew and operation of the AFS conflicted with each other, the THS ended up in an out-of-trim condition, and the crew had to deal with a rapidly changing aircraft attitude, without having time to grasp the full extent of the situation.

Such serious incidents occurred in March 1985, January 1989, and in February 1991 respectively.

Airbus Industrie informed operators of the summary of the these incidents, but did not present a systematic explanation on the technical background sufficiently.
- (3) As described in (1), three to four years elapsed before, in response to the incidents, Airbus Industrie introduced the modifications to the AFS. Considering the importance of the incidents, it is considered that the modifications were not introduced promptly enough.

The system to make acceptance of modification available to operators was completed at the FCC manufacturer in September, 1993 after Airbus Industrie issued the SB on June 24, 1993, as mentioned in section 3.1.10.3.
- (4) The China Airlines' A300-622R B-1816 aircraft which crashed at Nagoya Airport on April 26, 1994, had incorporated Mod.7187 when manufactured, and implementation of SB A300-22-6021 was planned. However this had not been done by the time the accident occurred.

It is considered that in the accident at Nagoya Airport, activation of the GO lever by the crew changed the mode to GO-AROUND mode, and since the crew later engaged the APs, the control wheel push-down operation by the crew, who seemed to have intended to continue approach, conflicted with the motion of the THS controlled by the AFS, resulting in an abnormal out-of-trim condition. If the modification prescribed in SB A300-22-6021 had been incorporated, it is considered that the APs would have been disengaged under a

force greater than 15Kgf applied at the control wheel in the nose-down direction, preventing the aircraft from entering such an abnormal situation.

However, China Airlines who received the SB judged its accomplishment not urgent and decided to implement the modification on an occasion when their FCC(s) needed repair.

Since operators had hardly grasped and understood the technical background and detailed information with regard to the three serious incidents described in the items of (1) and (2) above, it is considered that this decision was affected considerably by the fact that the SB was issued as “Recommended”, and not “Mandatory”, and the reasons and technical background for issuance of the SB were not explained clearly and in detail.

- (5) In view of the significance of those three incidents, it is considered proper that the French airworthiness authorities pertaining to aircraft design and manufacture, at an earlier stage, should have urged Airbus Industrie to establish the modification promptly to preclude the recurrence of similar incidents, and issued an airworthiness directive so that each operator could implement promptly the SB pertaining to the modification.

It is also considered necessary for the French airworthiness authorities to have requested Airbus Industrie to provide each operator with technical information describing each incident systematically.

3.1.11.4 FCOM of A300-600 Type Aircraft

- (1) Revision of FCOM Based on Mod.7187 (See Appendix 2-2 and 2-3)

After the incident involving an A300-600 aircraft on March 1, 1985, Mod.7187 (re-arranged into SB A300-22-6009 in June 1989) was established on March 18, 1988, introducing a function allowing AP disengagement in pitch axis in modes except LAND track (below 400ft radio altitude) and GO AROUND mode.

The condition of “LAND mode” was not clearly described in the FCOM issued in June 1988. It is ambiguous whether this meant a phase after LAND mode was selected on the FCU or a phase when “LAND mode” is displayed on FMA (LAND track mode). However, when SB A300-22-6021 dated June 24, 1993 (addition of function of allowing a pilot input in pitch axis to disengage the AP above 400ft radio altitude in GO AROUND mode) was implemented, the description in the FCOM concerning the above mentioned “LAND mode” was revised and clarified such that LAND mode meant a phase when “LAND mode” is displayed on the FMA.

- (2) Addition of CAUTION (See Appendix 2-2 and 2-4)

After the incident involving an A300B4-203FF aircraft at Helsinki Airport on January 9, 1989, FCOM 1.03.64 P 3/4 and 2.02.03 P 1 were revised in January, 1991, adding a CAUTION against a hazardous out-of-trim condition that may lead the hazardous situation if the AP is overridden in pitch direction during the LAND and GO-AROUND modes.

The FCOM describes that this override was concerned in order to protect the pilot against AP abnormal behavior. On the other hand the CAUTION in the FCOM prescribes that pilots are prohibited from overriding the AP when it operates normally.

Therefore, pilots may be confused and may receive two contradictory meanings, such as recommendation and prohibition. For example, if a pilot had suspected that the APs were malfunctioning, he might miss taking proper action because no criterion had been written as to the situations in which one should override.

Accordingly, the technical information, examples of possible situations, and the corresponding confirmation and operation procedures should be written in the FCOM systematically in order to encourage crews' further understanding of the AP overriding function.

(3) FCOM 1.03.67 P-8 REV 17 (A310/A300-600) (See Appendix 2-3)

① The FCOM section dealing with GO AROUND mode disengagement procedure is as follows:

* When a longitudinal mode is engaged (V/S, ALT, LVL/CH, ALT★, or PROFILE mode); - GO-AROUND mode disengages, and - HDG mode engages as lateral mode.

* When a lateral mode is engaged (HDG SEL, VOR CAPTURE or TRACK phase, NAV CAPTURE, or TRACK phase); the GO-AROUND mode disengages. However, the SRS mode, a longitudinal mode of GO-AROUND, remains active.

② According to the procedure in FCOM, if V/S mode is selected as a longitudinal mode when GO-AROUND mode is active, "GO AROUND" (a common mode) disappears from the FMA display and "V/S" and "HDG" (a lateral mode) both appear instead. Actually, the GO AROUND function is not completely disengaged, even though it appears from the FMA display that it has.

In order to completely disengage GO-AROUND mode, the pilot is required to select another lateral mode (HDG SEL, V/L, or NAV mode), making the FMA display change from "HDG" to the display corresponding to the selected lateral mode.

For example, if HDG SEL mode is selected, the FMA display changes from "HDG" to "HDG/S" and GO-AROUND mode is completely disengaged.

GO-AROUND mode is a common mode that combines both longitudinal and lateral modes, and is disengaged completely when both lateral and longitudinal modes are changed.

The FCOM description, however, does not mention that GO-AROUND mode does not disengage completely when only a longitudinal mode is selected. Readers, therefore, are misinformed as to the precise relationship between how the various modes are selected, how they are displayed on FMA, and how they actually work.

(4) Notice to each operator issued by Airbus Industrie after the Accident in Nagoya

After the accident involving a CAL Flight 140 at Nagoya Airport, which occurred on April 26, 1994, Airbus faxed all A300/310 and A300-600 aircraft operators cautionary information to be applied when a pilot moves the elevators in conflict with the APs while

the APs are in LAND or GO-AROUND mode (See Attachment 2-6).

In view of this information, Airbus Industrie recommend that the best way to disengage the GO-AROUND mode is to disengage the APs by means of the AP instinctive disconnect button, or to select another mode, and the subject information also states that if the AP is then disengaged, the aircraft is left in an out-of-trim situation which might be hazardous if not trimmed back.

This technical information describes the basic AP override function, examples of operations leading to an out-of-trim situation and the measures to be taken if this situation arises. It is considered that such cautions, which are specified definitely and clearly therein, need to be promptly included in adequate chapter or subject in FCOM.

3.1.11.5 AP Override Function

When the AP is in CMD, the AP actuators move the roll, pitch, and yaw control surfaces in response to commands from the FCC. The THS moves according to commands from the FAC.

The override function mechanically disconnects the AP actuator from the control surface and allows the pilot to manually control the aircraft by applying a force greater than a threshold on the control wheel or rudder pedals. When the force applied to the control wheel or rudder pedal is released, the AP actuators are reconnected to the corresponding control surfaces. However, the THS remains under control of the AP even while the AP is being overridden and continues to operate as commanded by the AP.

Airbus Industrie define the AP override function in their FCOM and FCOM Bulletin as a safety device to allow the flight crew to regain control from the APs in the event of AP anomalies. Airbus Industrie also recommend in the above bulletin that the pilot should disconnect the APs immediately, upon suspicion of any abnormal aircraft behavior when AP is in CMD (See Appendix 2-4 and 4.).

When the AP is in CMD, if the pilot overrides the AP's pitch command for some reason, the AP activates the auto-trim function and moves the THS so as to maintain the aircraft on the scheduled flight path. If the pilot disengages the AP without noticing this, the aircraft is left in an out-of-trim situation which might be hazardous if not trimmed back (See Appendix 2-6.).

In the case of a post SB A300-22-6021 aircraft, if the crew carry out an operation to hold the control wheel in an effort to decrease an excessive pitch angle at a radio altitude lower than 400 ft during a go-around started from a low altitude, the result will be the same as an AP override operation, causing the THS to move toward the nose-up direction. If the crew is not aware of the THS movement and does not make a trim-back operation, the aircraft could enter an out-of-trim situation, which is potentially hazardous.

3.1.11.6 Operation of Alpha Floor Function

As the aircraft continued descent in an out-of-trim condition, the pitch angle and the angle of attack (AOA) increased. The AOA exceeded the threshold angle of 11.5 degrees, corresponding to SLATS/FLAPS 30/40, while crossing approximately 550 ft pressure altitude at 14:57. The alpha floor function was activated, increasing power. Although, immediately after this, the thrust was reduced for a while, the go-around thrust was set again, and a rapid increase of the pitch angle continued.

In the case of this accident, the Alpha Floor function -- a safety device which is designed essentially to prevent stall and to protect aircraft within the flight envelop -- activated and increased the engine thrust when the THS was in full nose-up position. This generated a pitch up moment. Immediately after this, although the thrust was manually reduced for a short period, the pitch angle increased by 9.5°, up to 18.0°.

It is considered that the automatic increase of the thrust and the accompanying increase in pitch angle resulted in a narrowing range of selection for subsequent recovery operations, and a reduction in the time allowance for such operations.

3.1.11.7 Alpha Trim Function

It is considered probable that, after the CAP called "GO lever" at 1115:11, the alpha trim function came into operation about 15:21. The THS continued to move, and by 15:27 had reached -7.4° from -10.9° (where it had been at 15:21). Movement then appears to have stopped owing to the pitch-trim tripping.

Tripping of the pitch-trim is considered to occur when one of a certain number of conditions is met, such as when the AOA cannot be calculated correctly owing to low speed and unstable aircraft attitude. The alpha-trim function is designed to stabilize the longitudinal aircraft attitude by trimming the THS automatically in the nose-down direction (maximum 4° nose down), in conditions of high pitch and low speed.

3.1.11.8 THS-In-Motion Warning / Recognition Function

The A300-600 is equipped with the following systems, for the purpose of THS motion awareness.

- (1) Visual trim indicator: two indicators located on the center pedestal, on which the current position of the THS is displayed.
- (2) Manual pitch trim control wheels: two wheels with white strips located on both sides of the center pedestal. They turn according to the THS motion.
- (3) THS motion warning: continuous trimming by means of the electric pitch trim switch activates an aural warning (whooler).

In this event of the accident involving the THS, systems (1) and (2) above are not always in pilots' field of view, and cannot alert them actively to the THS motion. Moreover this accident occurred in night and the cockpit was dark, so it is considered that these two systems did not provide pilots with effective information as to the status of THS-movement.

Furthermore, system (3) above was not active during the approach phase of this flight, because the APs were engaged in CMD.

During the development stage of the A300-600 aircraft, the motion warning had been designed to provide an aural warning “Whooler” when THS motion occurred in either automatic or manual flight, but the warning function was later eliminated from automatic flight by a design change.

On this matter, from a statement by the British aircraft accident investigation authorities the circumstance is as follows;

The UK CAA in its evaluation summary for this aircraft type required that "Excessive operation of the trim in motion warning which occurs when trim is being applied at the high rate (flap extended) during autoland flare should be reduced."

Airbus Industrie chose to address this issue by deleting the trim in motion warning completely when the autopilot was in a command mode.

It is considered that, if the THS-in-motion warning had sounded continuously during an automatic flight, the crew would have recognized a significant change in flight configuration or suspected some anomaly in the AFS, and confirmed the operating conditions of the system.

A characteristic of the AP override function of A300-600 type aircraft is that a prolonged override of the AP acting on the pitch axis via the control wheel leads to an out-of-trim situation. Accordingly it is considered necessary for Airbus Industrie to have maintained the function of THS motion warning in the AP CMD or, if eliminated, to establish another warning and recognition function which alerts pilots directly and positively to know the condition of the THS.

3.1.12 Fire Fighting and Rescue

3.1.12.1 Fire Fighting and Rescue Service System

The fire fighting and rescue services at airports are specified in “Level of Protection to Be Provided” of Annex 14 “Aerodrome” to the Convention on International Civil Aviation and in the “Airport Services Manual” (hereinafter referred to as “ICAO Level”) pertaining to it. Incidentally, the stipulations contained therein are considered desirable for safety, exactitude, and efficiency, and are categorized as "Recommended Practices", but not "Standards" at the present stage. In Japan, however, the fire fighting and rescue service is understood in principle to conform with the "ICAO Level", deploying and operating required vehicles etc. accordingly.

Nagoya Airport is managed by Nagoya Airport Office. The airport is used for international scheduled flights. Next to the airport is Komaki Base, Japan Air Self-Defense Force.

The Nagoya Airport Office is in charge of fire fighting and rescue services for civil aircraft.

At the time of the accident, the office had an emergency medical services transport vehicle on standby which was loaded with medical supplies. The office did not have chemical fire vehicles and other fire/rescue vehicles on standby at that time, but was in the process of equipping itself with these vehicles and other necessary equipment. Even though equipment acquisition was not complete, the office was capable of providing fire fighting and rescue services that conformed to "Level of Protection to Be Provided" for Category 9 airports recommended in Annex 14 to the Convention on International Civil Aviation, by utilizing fire fighting and rescue vehicles assigned to Komaki Air Base, Air Self-Defense Force, based on an agreement with them. The fire extinguishing foam solution discharge rates, however, did not completely satisfy the specified level.

Additionally, agreements were signed with neighboring fire fighting organizations, permitting utilization of their support. The fire fighting and rescue standards at Nagoya Airport were as follows:

(1) Airport Category

Airports are ranked in categories from Category 1 to 9, based on the length and width of the fuselage of the largest aircraft which usually use the airport. Nagoya Airport is ranked Category 9, for Boeing 747 used the airport frequently.

(2) Required Amounts and Discharge Rates of Fire Extinguishing Foam Solution

The Airport Services Manual uses the concept of "critical area" as the basis for calculating the necessary amount and discharge rate of fire extinguishing foam solution, seeking to control only that area of fire adjacent to the fuselage of the aircraft involved in an accident, the area being determined with the overall length of the fuselage taken into consideration. (See Appendix 9.)

① Required Amount of Fire Extinguishing Agents

According to the ICAO Level, the minimum requirements for fire-extinguishing agents are 24,300 liters for water for foam production and 450kg for auxiliary fire-extinguishing agent.

The total amount of water for foam production, including water available from the six fire fighting and rescue vehicles (five chemical fire vehicles and a water supply vehicle) assigned at Komaki Air Base, Air Self-Defense Force, was 33,600 liters and that of the auxiliary fire-extinguishing agent was 550kg, conforming with the amounts specified in the ICAO Level.

② Discharge Rates

According to the ICAO Level, the minimum foam solution discharge rate is 9,000 liters/min.

The discharge rate of the five chemical fire vehicles was 7,500 liters/min (1,500 liters/min x 5) which was considered short of the rate recommended by the ICAO

Level.

This was due to the low discharge rate of each chemical fire vehicle.

The chemical fire vehicles assigned to Komaki Air Base had a discharge distance of approximately 30m.

(3) Response Time

According to the ICAO Level, the target time from when first notification of an accident is made to the rescue and fire fighting detachment until the rescue and fire vehicles arrive at the runway end, and actual activities are started, should not exceed three minutes. At the start of their fire fighting activities, the fire vehicles are required to discharge fire-extinguishing foam solution at a rate of at least 50% (4,500 liters/min) of the specified 9,000 liters/min rate; vehicles following the first ones should arrive subsequently at the crash site within one minute.

In the case of the accident, the ICAO Level was conformed to, since the rescue and fire vehicles arrived at the runway end within three minutes, and in the initial fire extinguishing activity the discharge rate of the preceding three vehicles was in excess of 4,500 liters/min.

(4) Numbers of Fire Fighting and Rescue Vehicles and Personnel

According to the ICAO Level, at least three fire fighting and rescue vehicles are required. Assigned to Komaki Air Base, Air Self-Defense Force were five chemical fire vehicles loaded with rescue materials and one water supply vehicle. The number of these vehicles was in excess of the number specified in the ICAO Level.

An ordinary fire vehicle was also assigned to Komaki Air Base, Air Self-Defense Force.

According to the ICAO Level, persons to be counted as fire fighting and rescue activity personnel are those who can get into rescue and fire vehicles immediately after an accident and operate the relevant equipment with maximum competence.

The number of appropriate personnel on duty at Komaki Air Base, Air Self-Defense Force at the time of the accident was six.

3.1.12.2 Fire Fighting and Rescue Training for Aircraft Accident

Fire fighting and rescue training for aircraft accidents are required to be conducted periodically, in order to maintain the competence of personnel who are to engage in fire fighting and rescue activities in the event of an emergency. Annex 14 "Aerodrome" to the Convention on International Civil Aviation has a "Standard" which requires all organizations concerned with fire fighting and rescue services to conduct pertinent training at intervals of less than two years. On May 24, 1993, organizations such as Air Self-Defense Force, neighboring fire fighting organizations, Airport Police and Medical Association of Aichi Prefecture, etc. participated in the fire fighting and rescue training for aircraft accidents under the auspices of Nagoya Airport Office.

3.1.12.3 Fire Fighting and Rescue Activities (Times are JST.)

Fire fighting and rescue activities were conducted as follows:

- (1) As for the response time of the fire fighting and rescue services, the fire platoon was notified of the occurrence of the crash at approximately 2016; the first group of three chemical fire vehicles (10,800 liters) was mobilized at approximately 2017, and commenced fire fighting and rescue activities immediately on arrival at the crash site, at approximately 2019.

However, the three succeeding vehicles, consisting of two chemical fire vehicles and one water supply vehicle, (22,800 liters in total) which were driven by the fire fighters who responded to the emergency call, arrived at the crash site at approximately 2030, a little later than the first group.

The total discharge rate of the first three chemical fire vehicles was 4,500 liters/min, and even after arrival of the second two chemical fire vehicles, the discharge rate was not more than 7,500 liters/min.

It is inferred therefore that the necessary amount of foam solution was not discharged at the initial stage of the fire fighting activity.

- (2) It is acknowledged that two ambulances from Komaki Air Base, Air Self-Defense Force arrived at the crash site at approximately 2019 and 2023, and mobile cranes, a light wrecker, etc., driven by personnel who responded to the emergency call, arrived at the crash site, and joined the rescue activities at approximately 2030.

- (3) It is acknowledged that fire vehicles, ambulances, etc. dispatched by neighboring fire fighting organizations, police, and Aichi Medical Association at the request of the Airport Office, began arriving one after another at the crash site from approximately 2027, and commenced rescue services such as confirmation of survivors, first aid and to transport of the injured.

- (4) It is recognized that the Aviation Safety Association controlled the traffic of emergency vehicles of the neighboring fire fighting organizations, guarded against entry of unauthorized personnel at the No.2 West Gate after the accident, had an emergency medical supply vehicle on standby with its engine running in front of their office at approximately 2030, and, on request from the neighboring fire fighting organization, at approximately 2115 sent the vehicle to the crash site, where it arrived at approximately 2122.

It is recognized that at the time of the crash, a large quantity of fuel (approximately 22,000 lbs) remained on board. It spilled around the airframe at the impact site, and ignited almost immediately. The fire propagated around the airframe, covering an area of approximately 70 square meters. Owing to wreckage scattered at the crash site well beyond the fire area, along with the irrigation water channel and revetment, access by the chemical fire vehicles to the crash site was restricted.

It is considered that the ICAO Level had been stipulated for the case of a fire breaking out in an aircraft which had been moderately destroyed and grounded on the runway. With regard to this accident, it is considered that fire fighting and rescue activities had been hampered by the above-mentioned conditions and, furthermore, by the fact that it occurred at night.

3.2 Summary of Analysis

3.2.1 General

- 3.2.1.1 The flight crew had valid airmen proficiency certificates and valid airman medical certificates.
- 3.2.1.2 The aircraft had a valid airworthiness certificate and had undergone maintenance and inspection as specified.
- 3.2.1.3 From the results of the investigation, it is estimated that the aircraft did not suffer any failures or malfunctions that contributed to the accident.
- 3.2.1.4 It is estimated that the weather around the time of the accident had not contributed to it.

3.2.2 Flight sequence of the Aircraft

The flight sequence is estimated to have been as follows:

- (1) While the aircraft was on ILS approach to Runway 34 of Nagoya Airport, under manual control by the F/O (PF), the F/O inadvertently triggered the GO lever.
- (2) This led the FD to change to GO AROUND mode, and thrust increased. The F/O (PF) applied nose-down input to the control wheel and reduced the thrust which was increasing, but these actions did not have sufficient effect. Consequently the aircraft deviated above its glide path and then leveled off.
- (3) The CAP (PNF) was most likely to have instructed the F/O (PF) to disengage GO AROUND mode.
However, the crew did not perform an adequate operation to change GO AROUND mode into LAND mode. Consequently the GO AROUND mode was not disengaged.
- (4) There is a possibility that the AP was engaged either by the CAP himself, by the F/O (PF) in accordance with the CAP's (PNF) instructions, or by the F/O without the CAP's consent, (or without notifying the CAP).
- (5) The F/O (PF) continued pushing the control wheel forward, in spite of its strong resistive force, in an attempt to recover the normal glide path above which the aircraft had deviated. He did so in accordance with the CAP's (PNF) instructions. The THS moved to its full nose-up position, leading to the abnormal out-of-trim condition.
- (6) Subsequently the APs were disengaged, but the out-of-trim situation still remained.
- (7) The AOA increased and the alpha-floor function was activated. This led to a thrust increase. As a result, a large pitch-up moment was generated because THS was still in

out-of-trim condition at this point of time.

- (8) At the time when the CAP took over the controls after being informed by the F/O that the thrust was latched, the CAP (PF) still seemed to intend to continue approach. Subsequently the CAP retarded the thrust levers once, but the nose-up tendency was strong and the aircraft led to a condition from which it was unable to recover its normal glide path. So the CAP probably decided to go around.
- (9) Because thrust was increased for go around and a flap-up operation was performed, the aircraft climbed steeply with the pitch angle increasing. Consequently speed decreased and the aircraft stalled.

3.2.3 Control and Operation by the Crew

- (1) It is considered that the decision by the CAP and the F/O to change from GO AROUND mode to LAND mode, as well as their subsequent actions to do so, was due to their inadequate understanding of the aircraft AFS.
- (2) With regard to the APs being engaged by either the CAP or the F/O: it is considered possible that they were attempting to recover the normal descent path by selecting LAND mode and using the assistance of the APs.
- (3) It is probably that the CAP did not recognize that the APs were engaged, or that although he recognized it, he believed he could continuously override the APs. His belief may have arisen either from confusion with regard to the supervisory override function of the A300-600R, or from his flight experience in B747.
In this regard, the fact that the aircraft was not equipped with a warning function which would alert the crew directly and actively to the THS movement, when the AP was engaged in CMD, is also considered to have had an effect on their judgment and actions.
- (4) The F/O did not report to the CAP either that he could not change modes or that the aircraft was not responding as desired (owing to a strong resistive force on the control wheel). Furthermore after the CAP had given further instructions and cautions to the F/O with regard to the mode change, he (the CAP) did not verify whether they were being properly followed.
- (5) During approach, the CAP had instructed the F/O to perform PF duty, assigning himself PNF duty. However, after the F/O triggered the GO lever, the CAP disregarded their duty assignment. It is considered that the CAP's judgment of the flight situation as PIC was inadequate, that control take-over was delayed, and that appropriate actions were not taken.
- (6) It is considered that the CAP intended try to continue the approach when he took control, but that he probably decided to go around when he found he could not stop the pitch angle increasing. Although the aircraft was climbing steeply with pitch angle still rapidly

increasing, the CAP seems not to have recognized, even at this time, that the aircraft was in an abnormal THS out-of-trim situation. This could be the reason why the CAP operated the Pitch Control Switch only intermittently, and did not reduce the excessively high pitch attitude.

3.2.4 Crash and Destruction of Aircraft

It is estimated that, after diving steeply without recovering from stall, and while rolling considerably, the aircraft impacted the ground almost in a level attitude. The aircraft was destroyed, and separated into forward fuselage, wings, aft fuselage, horizontal tail plane and vertical tail plane.

3.2.5 Investigation of Ethanol

There is a possibility that the ethanol detected in the remains of the CAP and F/O was due to a Post-Mortem ethanol production. The possibility of alcoholic ingestion before death could not be determined. The possibility that liquor loaded onboard splashed the bodies of the CAP and F/O could not be confirmed.

3.2.6 Operations and Training of China Airlines and Handling of Service Bulletins

3.2.6.1 Operations

It was recognized that China Airlines had an Operations Policy Manual and an Air Crew Manning and Dispatch Manual prepared in accordance with Taiwanese civil aviation laws, that the aircraft was operated according to these manuals, and that both the CAP and the F/O held valid qualifications for their respective duties.

The fact that the CAP had allowed the F/O to operate the aircraft on this flight is considered to satisfy the requirements of their crew qualifications, aircraft weight, weather conditions and airport. As described in Paragraph 3.2.3.(4), however, it is considered that the CAP's situational awareness of the flight conditions was inadequate and that control take-over was delayed.

3.2.6.2 Training

It is recognized that the CAP and the F/O completed classroom, simulator and flight training based on the training syllabus prepared by China Airlines in accordance with Taiwanese civil aviation laws.

However, it is recognized that this training was not necessarily sufficient to understand the sophisticated and complicated AFS system.

3.2.6.3 Handling of Service Bulletins

China Airlines received service bulletin SB A300-22-6021 issued by Airbus Industrie, on July 29, 1993. Since application of the service bulletin was categorized as "Recommended",

they judged its implementation not urgent and decided to implement the modifications specified in this SB when FCCs needed repair.

Therefore, this modification had not been incorporated in the aircraft by the time the accident occurred.

3.2.7 Automatic Flight System

3.2.7.1 Modification of AFS

- (1) Before this accident, there had occurred three incidents in 1985, 1989, and in 1991 which also involved an out-of-trim condition. It is recognized that Airbus Industrie had not provided operators with systematized and sufficient explanation about technical background with regard to these incidents, and the proposal for implementation of the AFS modification had been delayed.

In addition, implementation of SB A300-22-6021 pertaining to the modification was issued as “Recommended”, not as “Mandatory”, which prescribes the highest priority.

- (2) Despite the importance of these three incidents, the airworthiness authority, pertaining to the aircraft designed and manufactured by Airbus Industrie, did not issue promptly an airworthiness directive for implementation of the SB A300-22-6021.

3.2.7.2 FCOM

The contents of “Cautions” added to the FCOM, the descriptions in the revision to FCOM associated with the AFS modification, and the procedures for disengagement of GO AROUND mode are not easy to understand. In addition, FCOM does not specify systematically the primary purpose of the AP override function, the way to detect the out-of-trim situation, and the procedure by which crews can recover from it.

In addition to this, it is considered that of the technical information distributed by Airbus Industrie to each operator after the accident, the necessary and important items should be reflected in the main body of FCOM.

3.2.7.3 Activation of Alpha floor function under out-of-trim condition

The activation of alpha-floor function under the abnormal out-of-trim condition caused an sudden increase in the aircraft's pitch angle and contributed to its steep climb and subsequent stall.

3.2.7.4 THS Motion Warning and Recognition Functions

Airbus Industrie, during the redesign phase, eliminated the aural whooler function which had been provided in the original design as THS motion warning when the AP is in CMD. It is considered that Airbus Industrie did not conduct sufficient studies as to whether to maintain the function to provide crews with THS motion awareness and attract their attention to continuous THS movement when the AP in CMD, or to incorporate an alternative device which

can alert crews to the THS out-of-trim situation.

3.2.8 Fire Fighting and Rescue System

It is recognized that the Nagoya Airport generally had a fire fighting and rescue system almost in conformity to the “Level of Protection to be Provided”, recommended by the Convention to International Civil Aviation, except that the discharge rate of fire-extinguishing foam solution did not completely satisfy the specified level.

4. CAUSES

While the aircraft was making an ILS approach to Runway 34 of Nagoya Airport, under manual control by the F/O, the F/O inadvertently activated the GO lever, which changed the FD (Flight Director) to GO AROUND mode and caused a thrust increase. This made the aircraft deviate above its normal glide path.

The APs were subsequently engaged, with GO AROUND mode still engaged. Under these conditions the F/O continued pushing the control wheel in accordance with the CAP's instructions. As a result of this, the THS (Horizontal Stabilizer) moved to its full nose-up position and caused an abnormal out-of-trim situation.

The crew continued approach, unaware of the abnormal situation. The AOA increased, the Alpha Floor function was activated and the pitch angle increased.

It is considered that, at this time, the CAP (who had now taken the controls), judged that landing would be difficult and opted for go-around. The aircraft began to climb steeply with a high pitch angle attitude. The CAP and the F/O did not carry out an effective recovery operation, and the aircraft stalled and crashed.

The AAIC determined that the following factors, as a chain or a combination thereof, caused the accident:

1. The F/O inadvertently triggered the Go lever
It is considered that the design of the GO lever contributed to it: normal operation of the thrust lever allows the possibility of an inadvertent triggering of the GO lever.
2. The crew engaged the APs while GO AROUND mode was still engaged, and continued approach.
3. The F/O continued pushing the control wheel in accordance with the CAP's instructions, despite its strong resistive force, in order to continue the approach.
4. The movement of the THS conflicted with that of the elevators, causing an abnormal out-of-trim situation.
5. There was no warning and recognition function to alert the crew directly and actively to the onset of the abnormal out-of-trim condition.
6. The CAP and F/O did not sufficiently understand the FD mode change and the AP override function.
It is considered that unclear descriptions of the AFS (Automatic Flight System) in the FCOM (Flight Crew Operating Manual) prepared by the aircraft manufacturer contributed to this.
7. The CAP's judgment of the flight situation while continuing approach was inadequate, control take-over was delayed, and appropriate actions were not taken.

8. The Alpha-Floor function was activated; this was incompatible with the abnormal out-of-trim situation, and generated a large pitch-up moment. This narrowed the range of selection for recovery operations and reduced the time allowance for such operations.
9. The CAP's and F/O's awareness of the flight conditions, after the PIC took over the controls and during their recovery operation, was inadequate respectively.
10. Crew coordination between the CAP and the F/O was inadequate.
11. The modification prescribed in Service Bulletin SB A300-22-6021 had not been incorporated into the aircraft.
12. The aircraft manufacturer did not categorise the SB A300-22-6021 as "Mandatory", which would have given it the highest priority. The airworthiness authority of the nation of design and manufacture did not issue promptly an airworthiness directive pertaining to implementation of the above SB.

5. REFERENCES

5.1 Measures taken after the Accident

Measures taken by the authorities, operators and manufacture were as follows:

5.1.1 Taiwanese civil aviation authorities

- (1) As of May 3 1994, the authorities ordered China Airlines to complete the modification to the FCCs promptly, in accordance with the Airbus Industrie's SB(A300-22-6021).
- (2) As of May 7 1994, the authorities ordered China Airlines to provide supplementary training to A300-600R pilots, re-evaluate their proficiency and submit pilot training and reevaluation plans to the authorities.
- (3) As of September 5 1994, in compliance with CN (CN 94-185-165(B)) released by DGAC, the authorities issued an airworthiness directive, AD-83-A300-155, ordering flight manual revision and FCC modification within 24 months following the effective date of the directive. This was done in order to prevent an abnormal out-of-trim situation from arising from a prolonged override of the APs (engaged in CMD) by acting on the pitch axis via the control wheel, which could create difficulties in controlling the aircraft.

The authority also issued AD83-A300-155A, the revision to AD83-A300-155, in compliance with AD(94-21-07) released by FAA, and on February 15 1996, revised AD83-A300-155A in compliance with DGAC CN (CN94-185-165(B)R1).

5.1.2 China Airlines

- (1) China Airlines had completed the modifications specified in Airbus Industrie's SB(A300-22-6021) by September 7 1994.
- (2) China Airlines re-checked the proficiency of all their pilots. In particular, the re-checking of the A300-600R pilots was observed by officers of the Taiwanese civil aviation authorities.
- (3) China Airlines carried out special inspections of engines, flight control systems and autopilot systems on all their aircraft.
On the A300-600R aircraft in particular, unscheduled inspections (A checks) were completed by May 31 1994.

5.1.3 Bureau Enquetes Accidents (BEA), Direction General de l' Aviation Civile (DGAC), FRANCE

- (1) On June 8 1994, BEA transmitted the following recommendation to DGAC:

“We recommended that a study be performed for the modification of the aircraft, with all necessary accompanying measures, leading to the disconnection of autopilot when a pilot overrides it while in Land and Go Around modes. The modifications resulting from this study should be made mandatory.”

- (2) On August 17 1994, DGAC issued an airworthiness directive, CN(CN94-185-165(B)) (effective as of August 27 1994), to order flight manual revisions and FCC modification within 24 months of the effective date of the directive, in order to prevent an abnormal out-of-trim situation from arising by a prolonged override of the APs (engaged in CMD) by acting on the pitch axis via the control wheel, which could create difficulties in controlling the aircraft. Furthermore, on January 31 1996 (effective as of February 10 1996), DGAC issued CN94-185-165(B)R1 (revised from the previous CN) to order flight manual revision and other measures.

5.1.4 Airbus Industrie

- (1) Airbus Industrie notified all operators of A300/A310 and A300-600 aircraft by FAX (AI/ST-F 472.2200/94) dated May 5 1994 of the hazards of overriding the APs by means of the elevators while the APs are engaged in LAND or GO AROUND mode.
- (2) On December 13 1994, Airbus Industrie re-categorized modifications to FCC (stated in the already issued SB(A300-22-6021)) from "Recommended" to "Mandatory" in accordance with CN(CN94-185-165(B)) released by DGAC.

5.1.5 Civil Aviation Bureau, Ministry of Transport of Japan

- (1) The Civil Aviation Bureau handed Japan Air System a Notice of Director of Engineering Department entitled "Observance of Operating Procedures for Automatic Flight Control System Prescribed in Aircraft Operating Manual" on May 10 1994, and gave instruction on the following matters, while requesting them to submit reports of the measures that they would take to conform to the instructions;
 - ① Positive verification of selected AP modes during approach.
 - ② Thorough understanding of operating procedures for disengagement of Go Around mode specified in the Aircraft Operating Manual.
 - ③ Thorough attention to the following cautions regarding the use of Autopilot specified in Paragraph 1 "General (5-5-1)" of Section 5 "AFS" of Chapter 5 "Procedures and Techniques" and (4) "AP in CMD" in Paragraph 5 "Autopilot/Flight Director" of Section 3 "Automatic Flight" of Chapter 8 "Systems" in the Aircraft Operating Manual for Airbus A300-600 series aircraft;
 - a. Working on the pitch axis against the AP in CMD may lead to a hazardous situation in LAND and GO AROUND mode. So if any abnormal flight control behavior is encountered during these flight phases:
 - check AP status (FMA, FCU)
 - if AP engaged, disconnect it and take over.
 - b. On the longitudinal axis, autopilot override does not cancel the AP auto-trim orders. So with AP in CMD, if the pilot counteracts the AP (elevators orders), the AP will move the THS (autotrim orders) so as to maintain the aircraft on the scheduled flight path. A risk of out-of-trim is real and may lead to a hazardous situation in land and go-around mode only.

- ④ Monitoring of operating conditions of the trim control wheel during approach, in particular when the AP is engaged.
 - ⑤ Early implementation of the company's plan to accomplish the FCCs modification (Airbus SB A300-22- 6021) to add an autopilot disengagement function which is activated by applying a force on the control wheel in Go Around mode above 400 feet radio altitude.
- (2) On May 10 1994, the Bureau requested, through an appropriate channel, the Taiwanese civil aviation authorities to re-instruct China Airlines in order to be absolutely assured of flight safety, and at the same time inform them of the fact that the actions shown in the above paragraph (1) had been taken.
 - (3) On May 12 1994, the Bureau issued an instruction to Japan Air System saying that the company should also take similar measures for the Airbus A300B2K-3C and A300B4-2C series aircraft, operated by the company, which contain the same AFS characteristics as those of the A300-600 aircraft.
 - (4) On August 25 1994, the Bureau issued an airworthiness directive, TCD(TCD-4078-94, effective as of August 27 1994), ordering that, with regard to A300B4-220FF, A300B4-203FF and A300B2-203FF aircraft as well as A310 and A300-600 series aircraft, the flight operating manuals should be revised and the FCCs modification mentioned in the above paragraph (1)-⑤ accomplished within 24 months in order to prevent an out-of-trim situation from arising from control wheel operation while the AP(s) engaged in CMD mode, which could create difficulties in controlling the aircraft.
This TCD complied with the airworthiness directive, CN(CN 94-185-165(B)) of DGAC.
Also, on February 2 1995, the Bureau issued TCD-4078-1-95 (a revision from the above-mentioned TCD), effective as of the same day, which required implementation of the changes included in the revision within seven days of the effective date of the TCD. This revision complied with the airworthiness directive AD(94-21-07) issued by Federal Aviation Administration (FAA) of the U.S.A.
 - (5) The Bureau is planning to deploy a large chemical fire vehicle (loading capacity of 12,000 litters), a water supply wagon (loading capacity of 8,000 litters) and a electric power supply wagon in fiscal year 1995 through 1996, as well as a large chemical fire vehicle (loading capacity of 12,000 litters) and a chemical fire vehicle (loading capacity of 4,500 litters) in fiscal year 1996 through 1997 at Nagoya Airport Office.

5.1.6 National Transportation Safety Board (NTSB) and Federal Aviation Administration (FAA), U.S.A.

- (1) The NTSB made the following recommendations to the FAA:
 - ① Require operators of the Airbus A300 and A310 series airplanes to provide immediate and recurrent training to flight crews on the hazards of attempting to counter autopilot commands by manual control forces when the airplane is being flown with the autopilot engaged in the LAND or GO AROUND mode (A-94-164).

- ② Review the logic of the Airbus A300 and A310 series automatic flight control systems and require modification as necessary so that the autopilot will disconnect if the pilot applies a specified input to the flight controls or trim system, regardless of the altitude or operating mode of the autopilot. (A-94-165)
 - ③ Require modification of Airbus A300 and A310 series autopilot systems to ensure that the systems provide a sufficient perceptual alert when the THS is in motion, irrespective of the source of the trim command. (A-94-166)
- (2) The FAA issued the following airworthiness directives (AD 94-21-07), effective as of November 2 1994:

Applicability: all Model A310 and A300-600 series airplanes.

- ① Within 10 days after the effective date of this AD, revise the Limitations Section of the FAA-approved Airplane Flight Manual(AFM).
- ② Within 60 days after the effective date of this AD, modify the FCC's in accordance with Airbus Service Bulletin A300-22-6021.

6. SAFETY RECOMMENDATIONS

As a result of the accident investigation, the Aircraft Accident Commission makes the following recommendations:

1. To the Taiwanese civil aviation authorities:

Require China Airlines to implement the following:

(1) Reinforcement of education and training programs for flight crews

- ① Understanding of the design concept of advanced technology aircraft and establishment of the operational concept for such aircraft

Since it is considered to be important in the operation of advanced technology aircraft for an airline to establish its own operational concept based on a full understanding of the design concept of the manufacturers, China Airlines should reinforce the education and training system for flight crews so that each crew member will fully understand the concept and its application can be rooted more firmly in daily operations.

- ② Reinforcement of education and training on the Automatic Flight System.

China Airlines should review the following to deepen crews' understanding of the AFS functions of advanced technology aircraft.

- a. The reinforcement of education and training programs for controls and operations which crews rarely experience in daily flight, such as mode changes and manual overrides during auto flight.
- b. The establishment of measures which allow crews to easily recall the controls and operations described in a. above in flight in order to effectively implement them.
- c. Methods for enhancing crews' understanding of important technical information on flight operations issued by aircraft manufacturers.
- d. Measures to ensure that through education and training, crews do not activate the GO-lever of the A300-600R inadvertently, and that they take appropriate actions if this occurs.

(2) Establishment of appropriate task sharing

China Airlines should review the following to ensure that Cockpit Resource Management is performed most effectively when the CAP has the F/O to perform the PF task.

- a. Task sharing between the CAP and the F/O.
- b. Situations which require the CAP taking over the PF task from the F/O.

- c. Implementation of preflight briefing on mutual confirmation of the items of a. and b. above.

(3) Improvement of crew coordination

① Standardization of terms

China Airlines should standardize the terms used for instruction, response, confirmation and execution of operations in order to ensure that crews can have appropriate situational awareness of the flight.

② Procedures of AFS mode change

China Airlines should improve the procedures for mutual confirmation by crews of operation and monitoring of the AFS mode changes of advanced technology aircraft.

③ Reinforcement of standard call out

China Airlines should ensure the implementation of standard call outs in order to enhance the effectiveness of ① and ② above.

(4) Establishment of standardization of flight.

China Airlines should standardize flights by prescribing items that must be checked according to the flight attitude. This will 1) allow crew members to have an adequate situational awareness of the flight conditions and make the correct decisions based on their awareness, and 2) eliminate any effects of crew members' individuality.

2. To Airworthiness Authority of France:

Require Airbus Industrie to implement the followings;

(1) Improvement of the AFS functions of A300-600R

① Improvement of the AP disconnect and override functions

Airbus Industrie should review the AP disconnect and manual override functions, by which crews can safely control the aircraft irrespective of flight altitude or phase by applying a force exceeding a certain level on the control column.

② Incorporation of out-of-trim prevention functions

Airbus Industrie should consider incorporating functions to prevent an abnormal out-of-trim condition from arising from a prolonged override operation of the autopilot by acting on the pitch axis via the control column, which moves the THS in the opposite direction to the elevator movement.

In this connection, Airbus Industrie should review the relationship between the Alpha floor function and out-of-trim condition.

③ Improvement of warning and recognition functions for THS movement

Airbus Industrie should study warning and pilot-recognition enhancement functions which alert the pilots directly and actively to those situations which arise when the THS enters, or is close to, an out-of-trim situation, or when it continues to move for more than

a certain period of time, regardless of AP engagement or disengagement.

(2) Improvement of descriptions in the FCOM of the A300-600R type

The descriptions of the following in the FCOM of A300-600R should be improved from the operational viewpoint.

- ① AP manual override
 - the purpose of the function
 - the descriptions of the system
 - the difference between the supervisory override function and the manual override function
 - the examples of possible situations which may arise, the corresponding procedures for confirmation and subsequent operations to be performed.
- ② Disengagement of GO AROUND mode
 - the procedure for disengagement
 - the procedure for selecting other modes
 - the connection between the display changes on the FMA and the actual changes occurring in the aircraft.
- ③ Recovery procedures from out-of-trim situation
 - examples of possible scenarios and their corresponding detection procedures
 - the recovery procedure from out-of-trim situation when the AP is engaged and disengaged, respectively.

(3) Positive dissemination of technical information to operators

In the event of an accident or serious incident, Airbus Industrie should promptly disseminate the systematical explanation of its technical background to each operator, and furthermore should positively and promptly develop modifications, prepare the Service Bulletin(SB) and revise the FCOM to preclude the recurrence of such incidents.

3. To Airworthiness Authority of France:

Review the following along with Airbus Industrie.

A review of the AFS, taking into account crews' ability and behavior in an emergency or abnormal situation.

The AFS is designed with various factors under consideration; its functions are complicated. Therefore there are some occasions where it would be difficult for pilots to recognize the operating condition of the AFS or properly predict the effect of a mode change on the flight. There is a possibility that crew might be unable to take proper action when using functions which are rarely used in daily flights.

Because human thinking ability is restricted in times of high stress, such as in an emergency or abnormal situation, it would be even more difficult for crews to take action within a limited period.

It is considered that there is a limit to how thoroughly a crew can be taught to deal with such situations by routine education and training.

Accordingly the design of the AFS (function, mode display method, warning and crew recognition function) should be reviewed, taking into account pilot's behavior and human cognitive process under an emergency or abnormal situation.

7. PROPOSALS

In view of the China Airlines accident, the Aircraft Accident Investigation Commission proposes the following to Minister of Transport of Japan.

1. Standardization of AFS specification for advanced technology aircraft

With regard to the AFS functions of advanced technology aircraft presently operated by Japanese airlines, there exist functions, the details of which, with the present level of education and training, cannot easily be understood or used by crew members, such as: man-machine interface-related functions, e.g., the function, display and operational procedure for flight mode, and AP override and disconnect functions; flight-protection functions.

There also exist differences in the above AFS functions among different aircraft manufacturers.

The above functions are directly linked to flight safety, and are deeply connected with the theory of how to carry out aircraft-type transition training for airline pilots. Considering these points a study should be conducted, from the standpoint of the state of operator, as to the following, in relation to the AFS functions described above:

- 1) Items to be covered by crew training;
- 2) Items to be considered in AFS design.

As to the items of which the specifications are desired to be standardized, an appropriate measures should be taken, via relevant international organizations or other appropriate bodies, to encourage such standardizations to be incorporated, by the state of design and manufacture, into AFS specifications.

2. Reinforcement of the fire fighting and rescue system

As to the civil aviation fire fighting and rescue systems at airports in Japan, an urgent review should be made and the necessary measures taken in relation to the following, taking into account possible accident scenarios:

- reinforcement of the command system in an emergency;
- ① facilities and equipment required for fire fighting and rescue operations;
 - ② cooperation with related authorities and parties;
 - ③ periodic training, and so on.

Attached Figure 1 Planned Flight Route

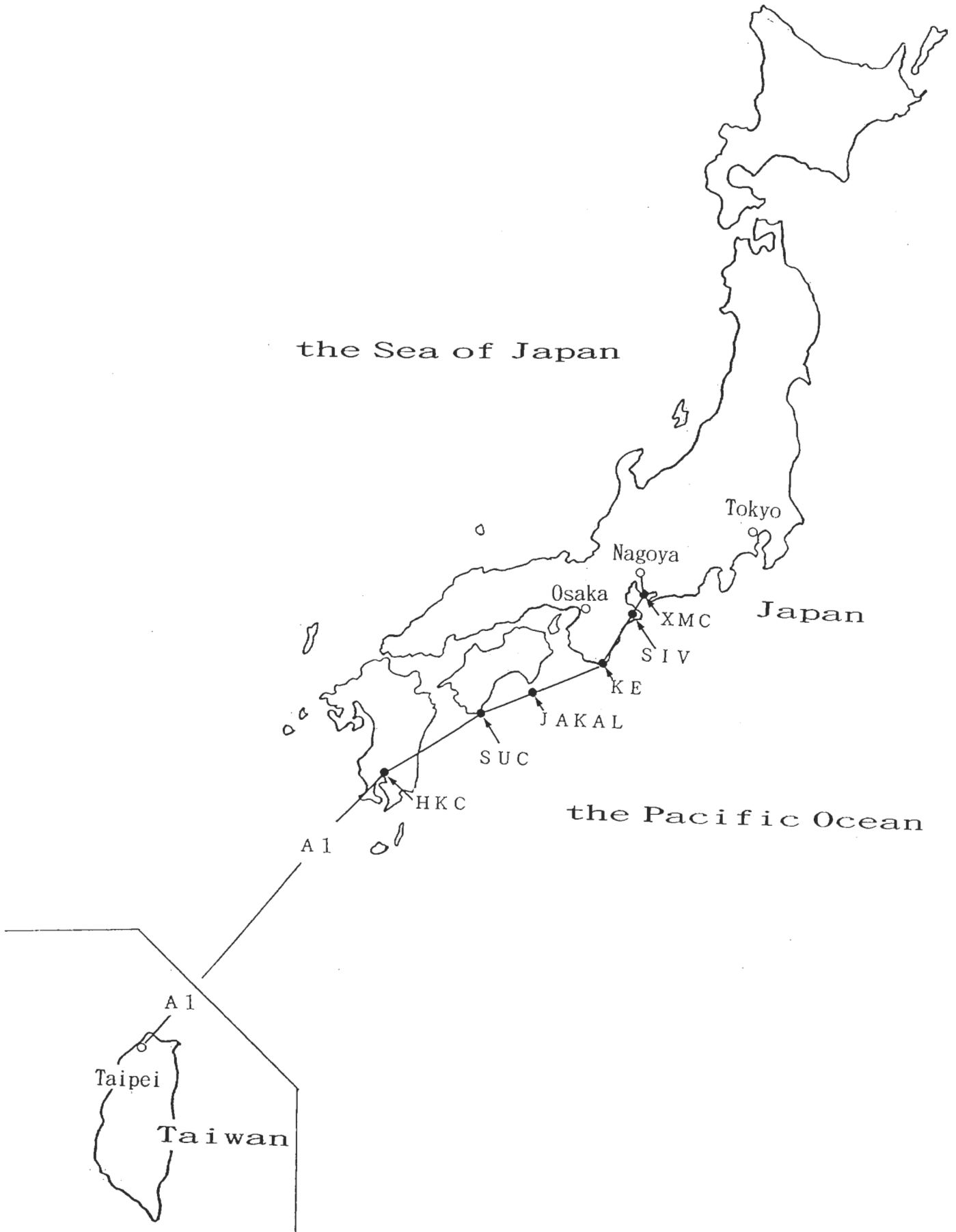

Attached Figure 2 Estimated Flight Route

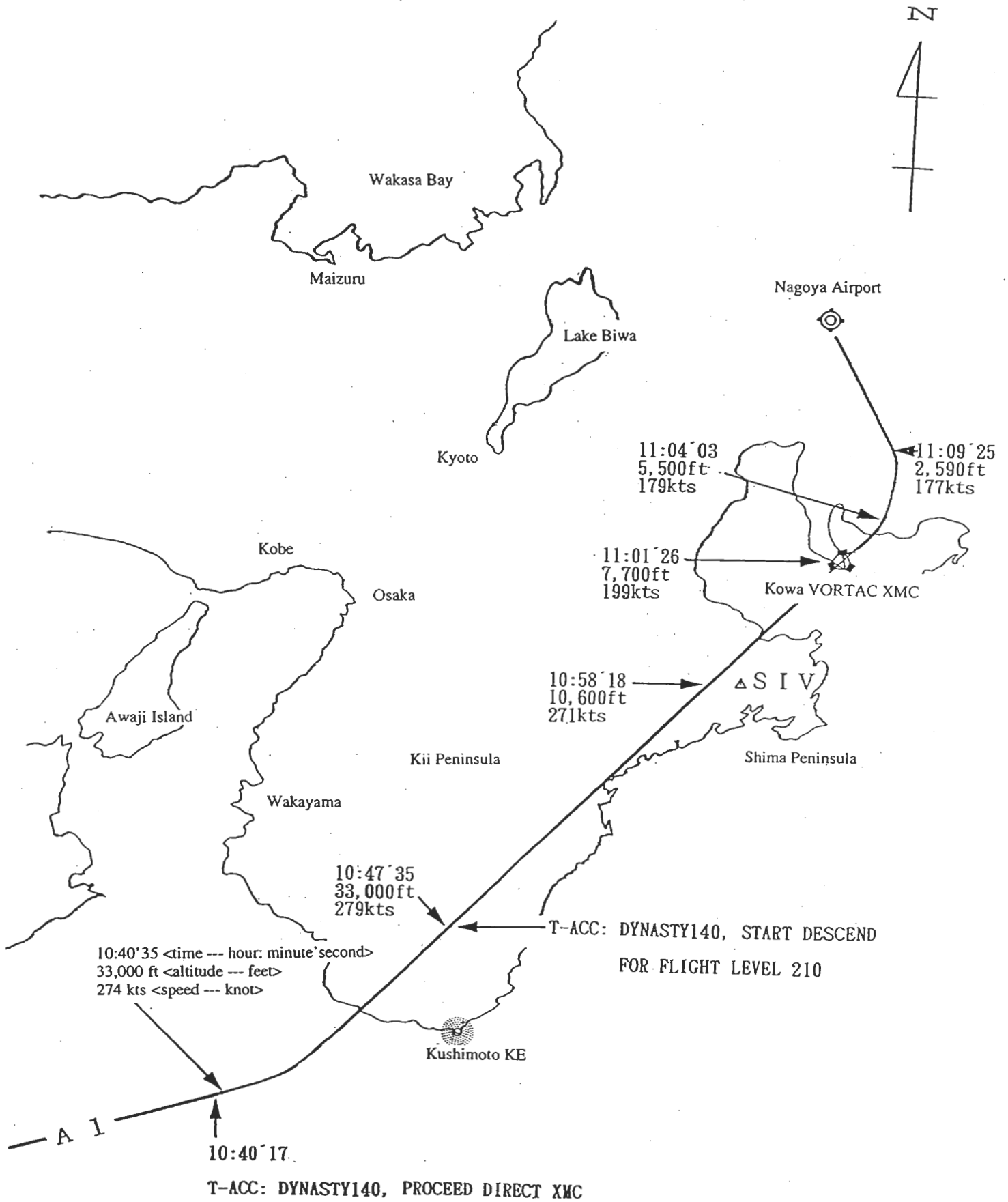

Attached Figure 3 ILS Approach Chart (Nagoya ILS RWY 34)

AIP JAPAN
RJNN

NAGOYA ILS RWY34

NAGOYA APP 134.1 - 120.3 270.8 - 362.3	ILS - LLZ 111.7 IKC ≡≡≡ ILS-GP 333.5	NAGOYA TOWER 118.7-122.7-126.2 236.8-305.7	RADAR AVAILABLE ATIS 126.4
--	--	--	-------------------------------

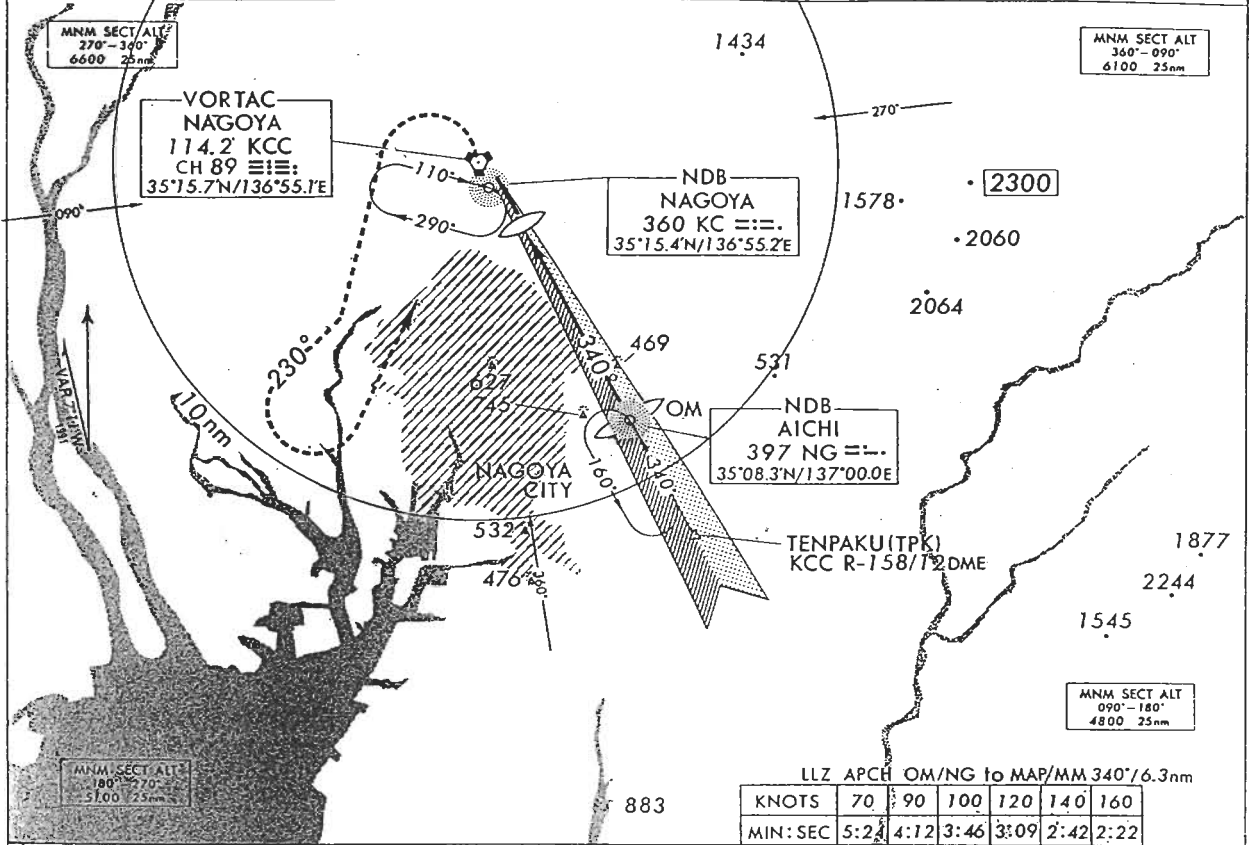

KNOTS	70	90	100	120	140	160
MIN: SEC	5:24	4:12	3:46	3:09	2:42	2:22

ILS REFERENCE DATUM 60'

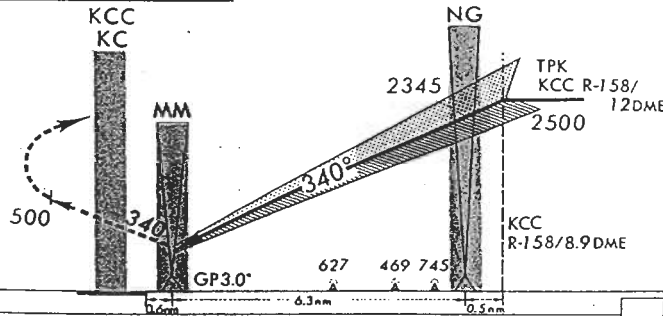

MISSED APPROACH
 At DA, climb to 500' on 340°, turn left climb via KCC R-230 (230° from KC NDB) to 3000', then turn left proceed to KCC VORTAC (KC NDB) within KCC 10 DME (10nm of KC NDB) and hold.
 Contact NAGOYA APP.

DA 302'				STA TO RWY 34		FIELD ELEV 46 ft TDZ ELEV 52 ft		CIRCLING MDA-VIS
FULL ILS TDZ & RCL LGT AVBL				TDZ &/OR RCL LGT OUT		MDA 780'		
			ALS OUT	MM OUT	GP OUT	GP & ALS OUT		
A					RVR 1200m VIS 1200m	VIS 1900m	780' - 1900m	
B	RVR 1200m	RVR 1200m	RVR 1200m	RVR 1200m	RVR 1600m VIS 1500m	VIS 2300m	780' - 2300m	
C	VIS 1200m	VIS 1200m	VIS 1200m	VIS 1200m	VIS 2100m	VIS 2900m	780' - 2900m	
D					VIS 3200m	VIS 4000m	780' - 4000m	

Attached Figure 4 Approximate Flight Track

- * This has been prepared as a result of DFDR analysis.
- * The axis of ordinates denotes absolute altitude obtained by compensation calculations and the axis of abscissas denotes distance.

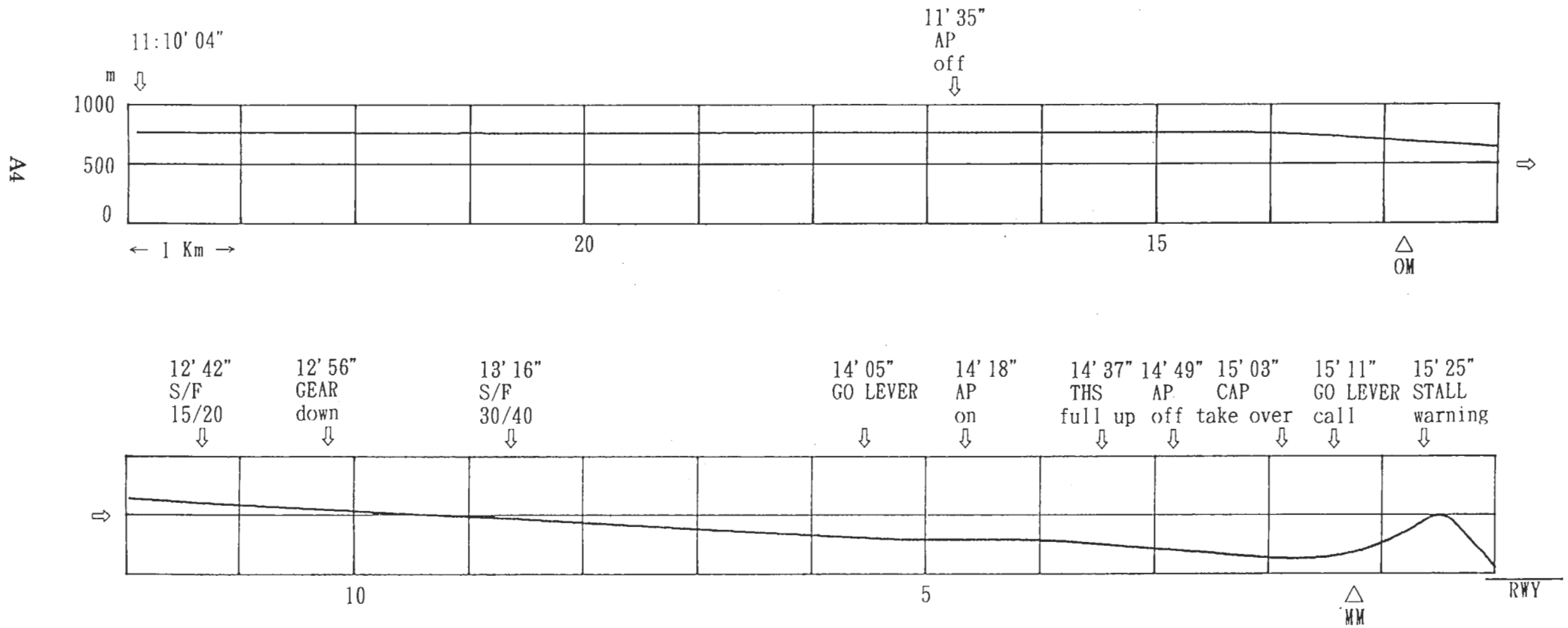

Attached Figure 5 Enlarged Flight Track.

* This has been prepared as a result of DFDR analysis.

* The axis of abscissas denotes time, and the altitude has been compensated according to radio altimeter values.

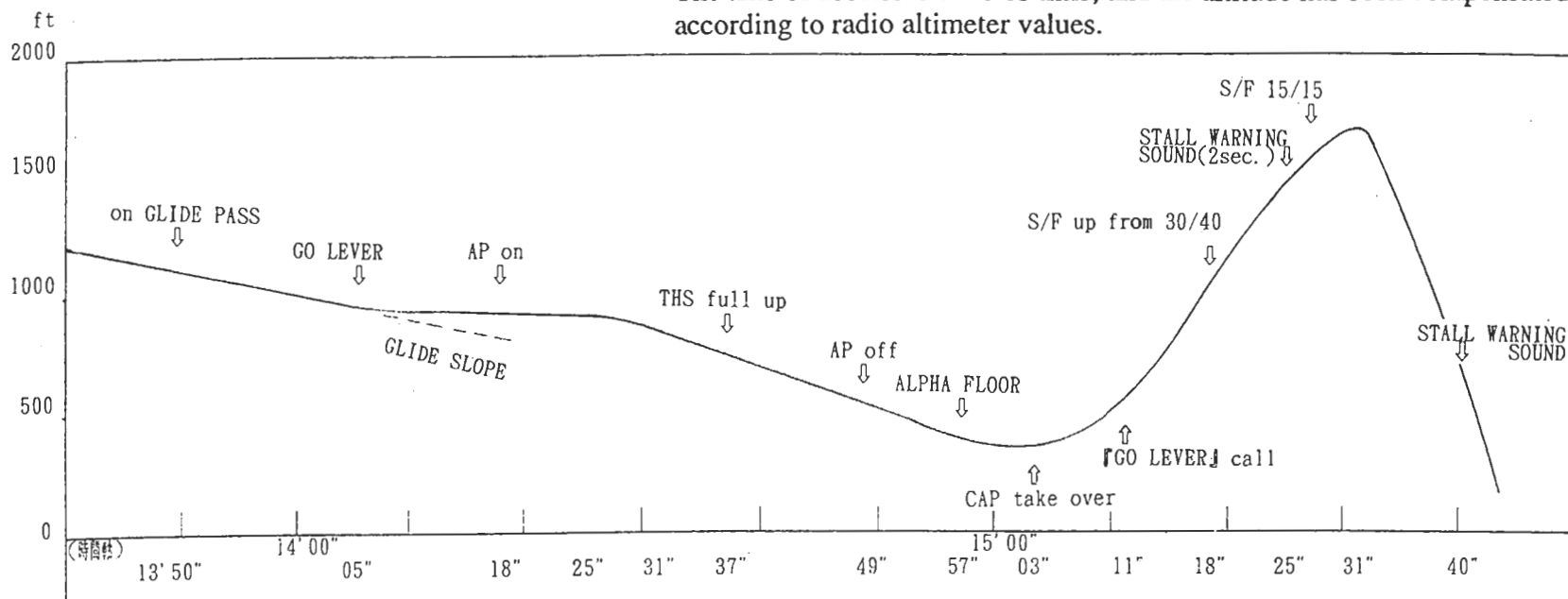

PITCH (度)	3.9	4.0	5.3	4.6	1.2 1.8	3.5	5.5	8.6	10.6	21.5	36.2	52.2	43.8	-12.0
AOA c (修正後) (度)	6.5	6.3	5.0	4.6	5.3	7.1	9.6	12.2	10.4	8.7	11.9	24.5	+(28)	32.1
CAS (kt)	139	141	145	146	141	138	129	127	128	135	124	87	+(34.3)	102
EPR #1/#2	1.09/1.08	1.10/1.09	1.18/1.17	1.03/1.03	1.01/1.01	1.00/1.00	1.04/1.04	1.04/1.04	1.30/1.30	1.35/1.52	1.47/1.27			
ELEVATOR *1 (度)	0.7	0.3	3.5	5.6	6.0	8.5	9.9	9.9	14.1	14.1	14.1	11.7	11.3	-10.2
THS *2 (度)	-5.3	-5.3	-5.3	-6.7	-9.5	-12.3	-12.3	-12.3	-12.3	-12.3	-11.3	-8.1	-7.4	-7.0

*1: Movable range -30 to 15°, accuracy ±0.9°, <0 = Nose Up

*2: Movable range (Electrical) -13 to 2.5°, accuracy ±0.9°, <0 = Nose Up

Attached Figure 6 Surface Chart (ASAS)

At 15:00, April 26, 1994

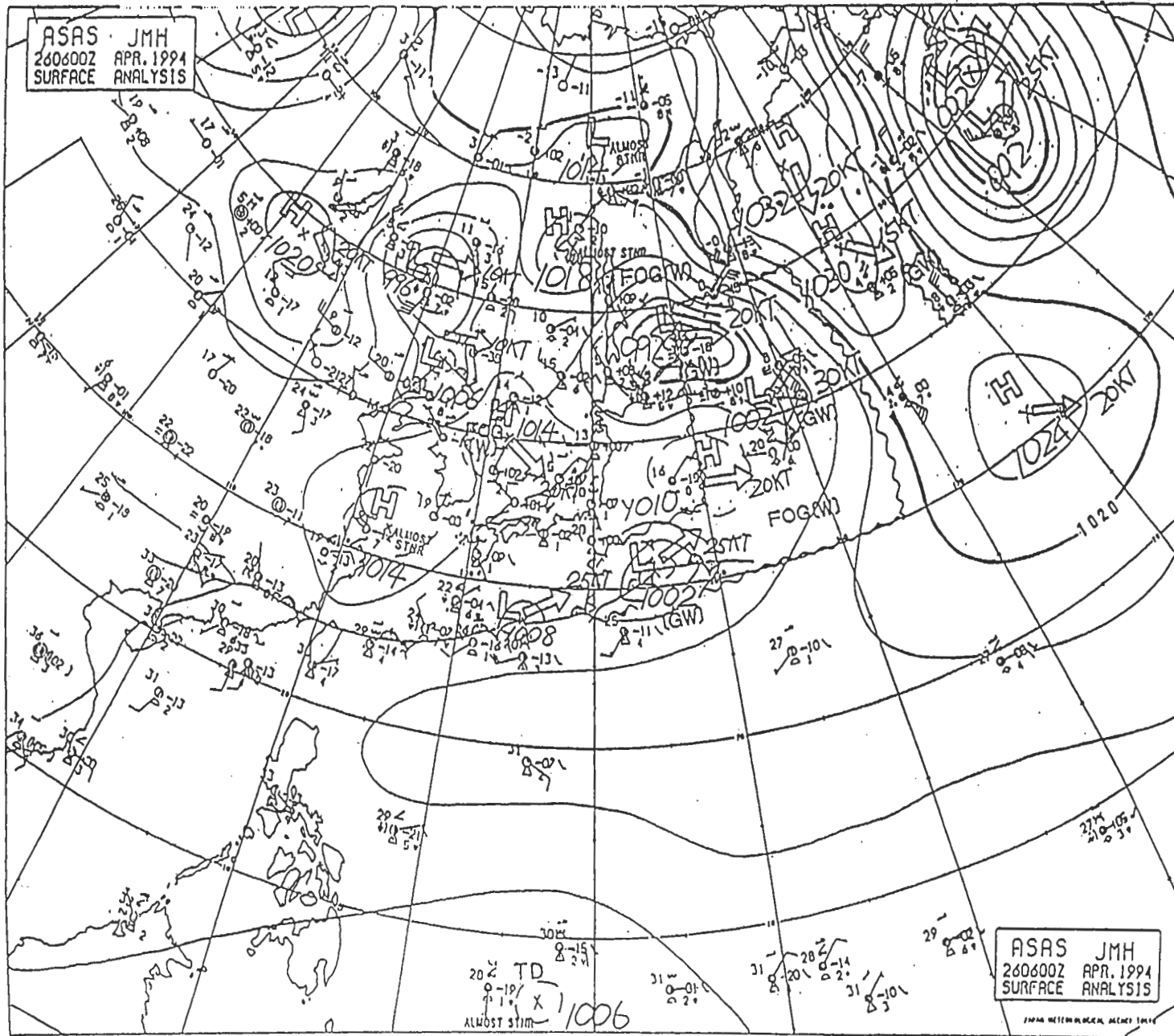

Attached Figure 7 Surface Chart (ASAS)

At 21:00, April 26, 1994

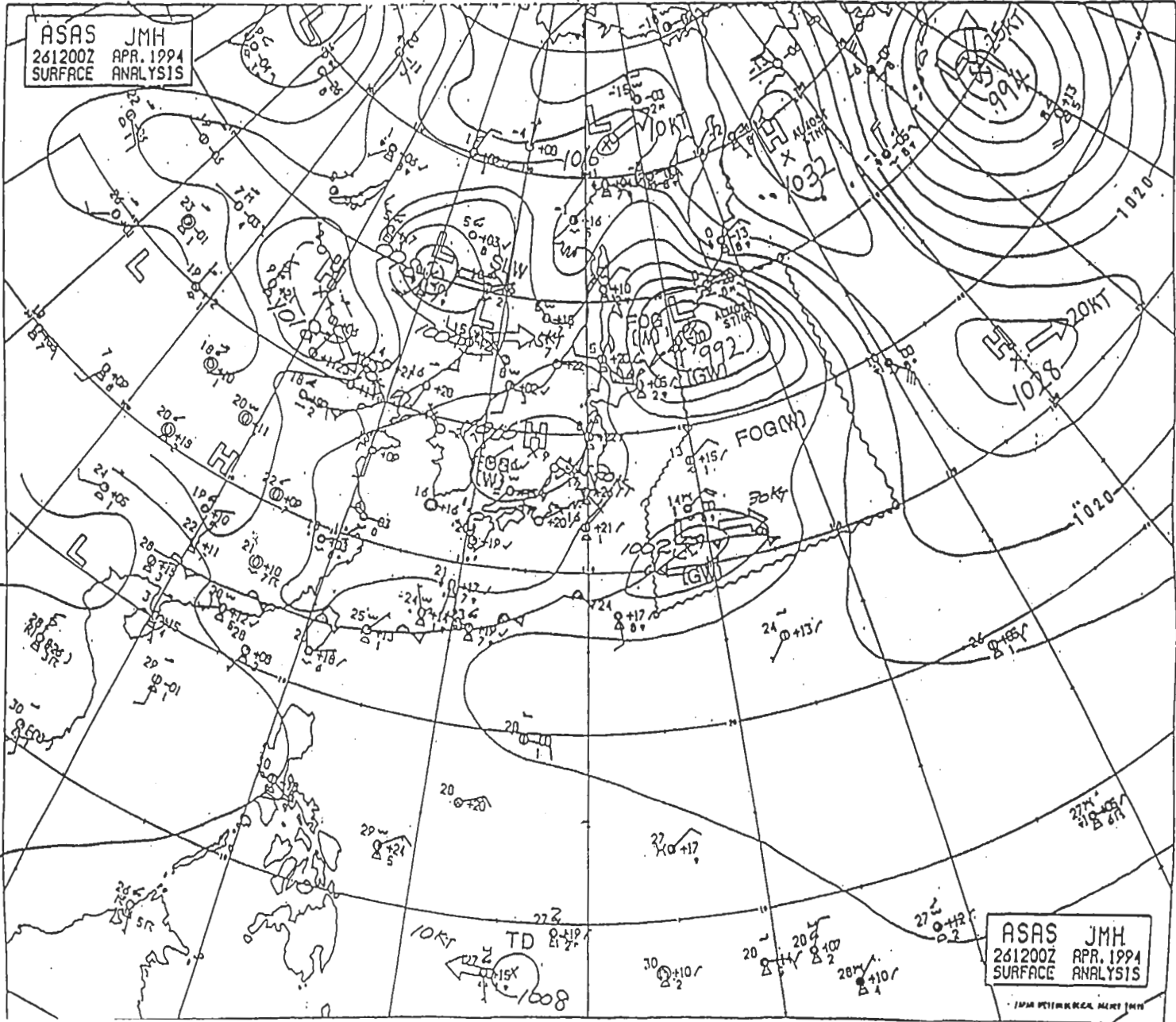

Attached Figure 8 Drawing of Nagoya Airport

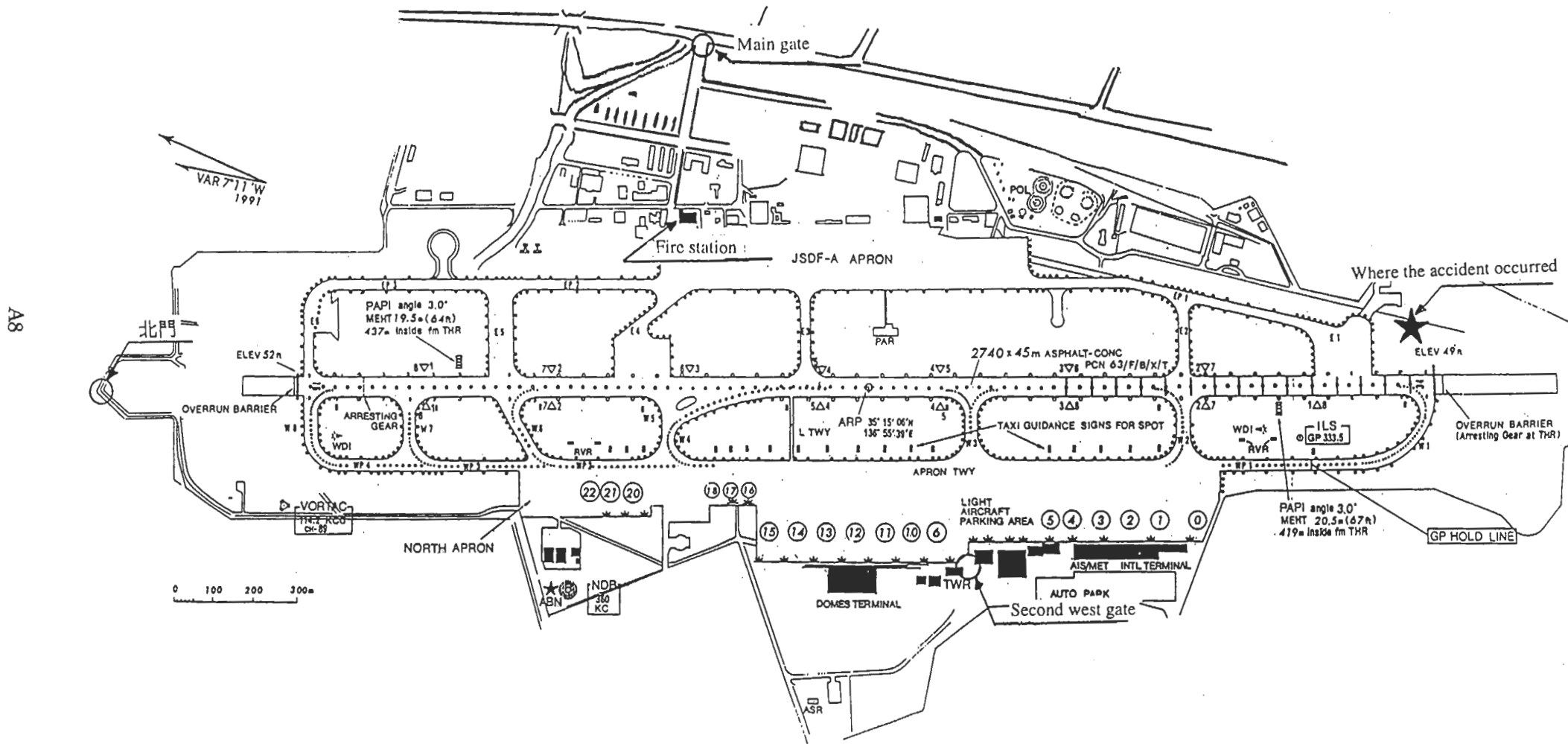

Attached Figure 9 Sketch of Wreckage on the Ground after the Crash

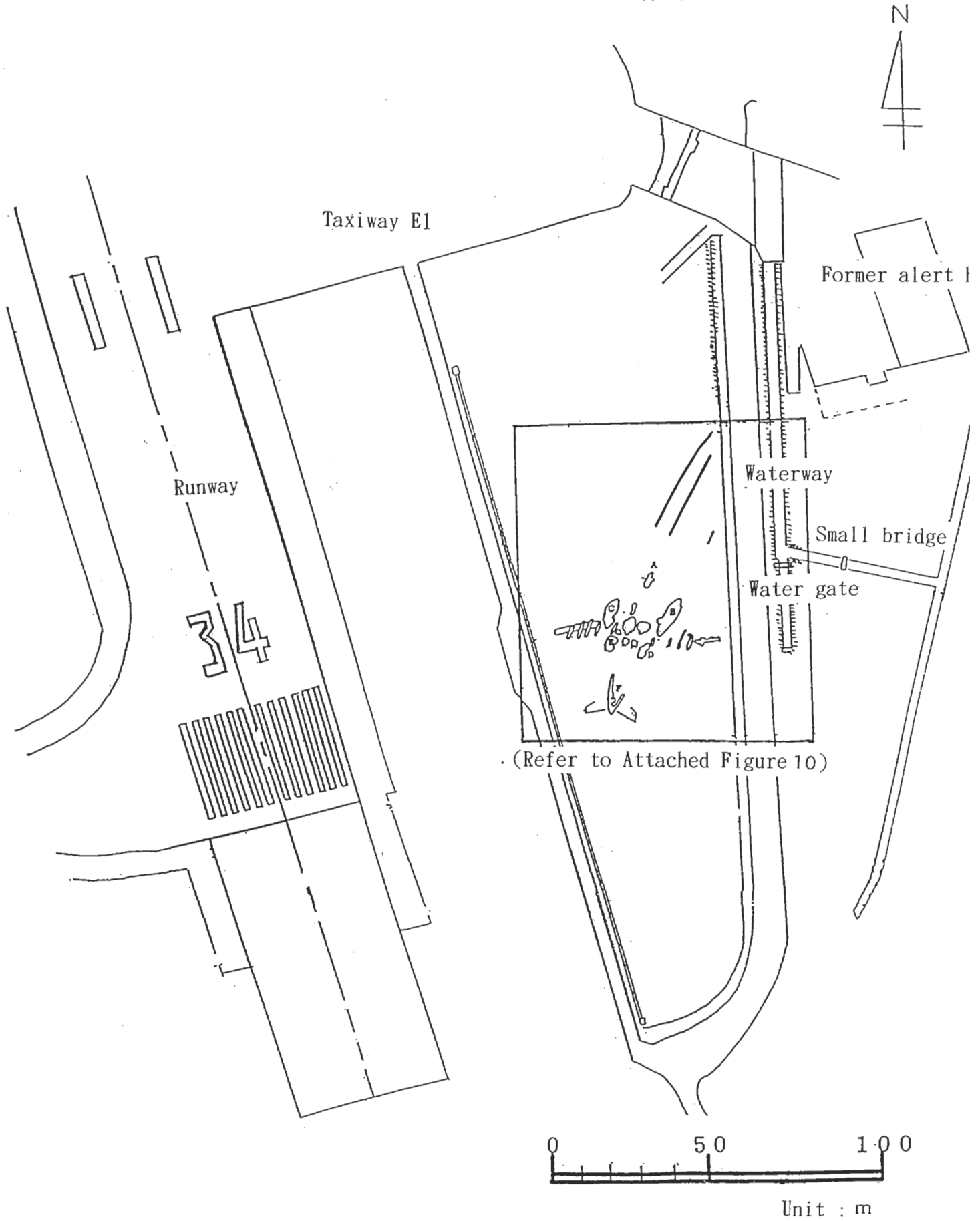

Attached Figure 10 Enlarged Sketch of Wreckage on the Ground

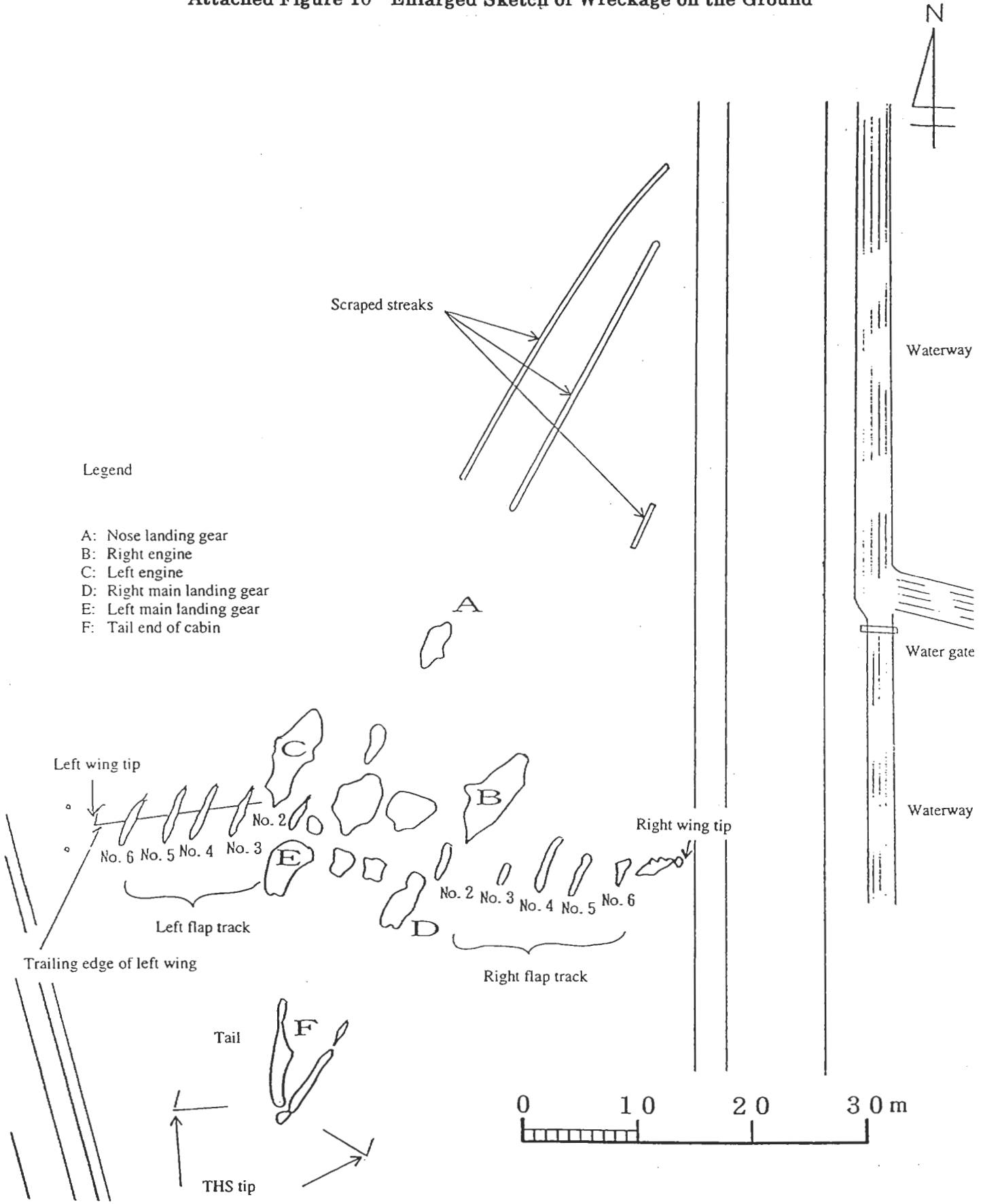

Attached Figure 11 Main Wreckage of the Accident Aircraft

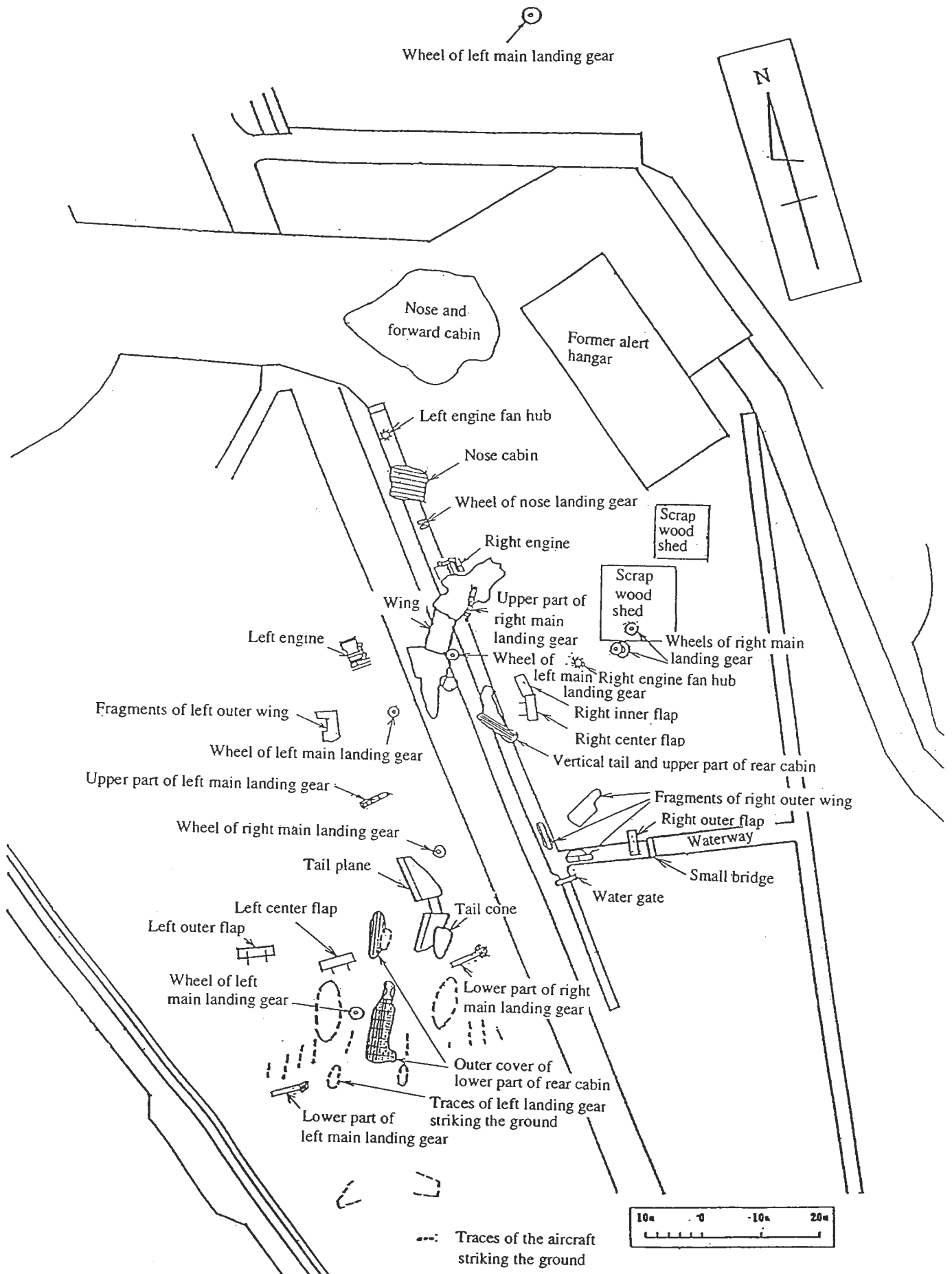

Attached Figure 12 Traces of Fire

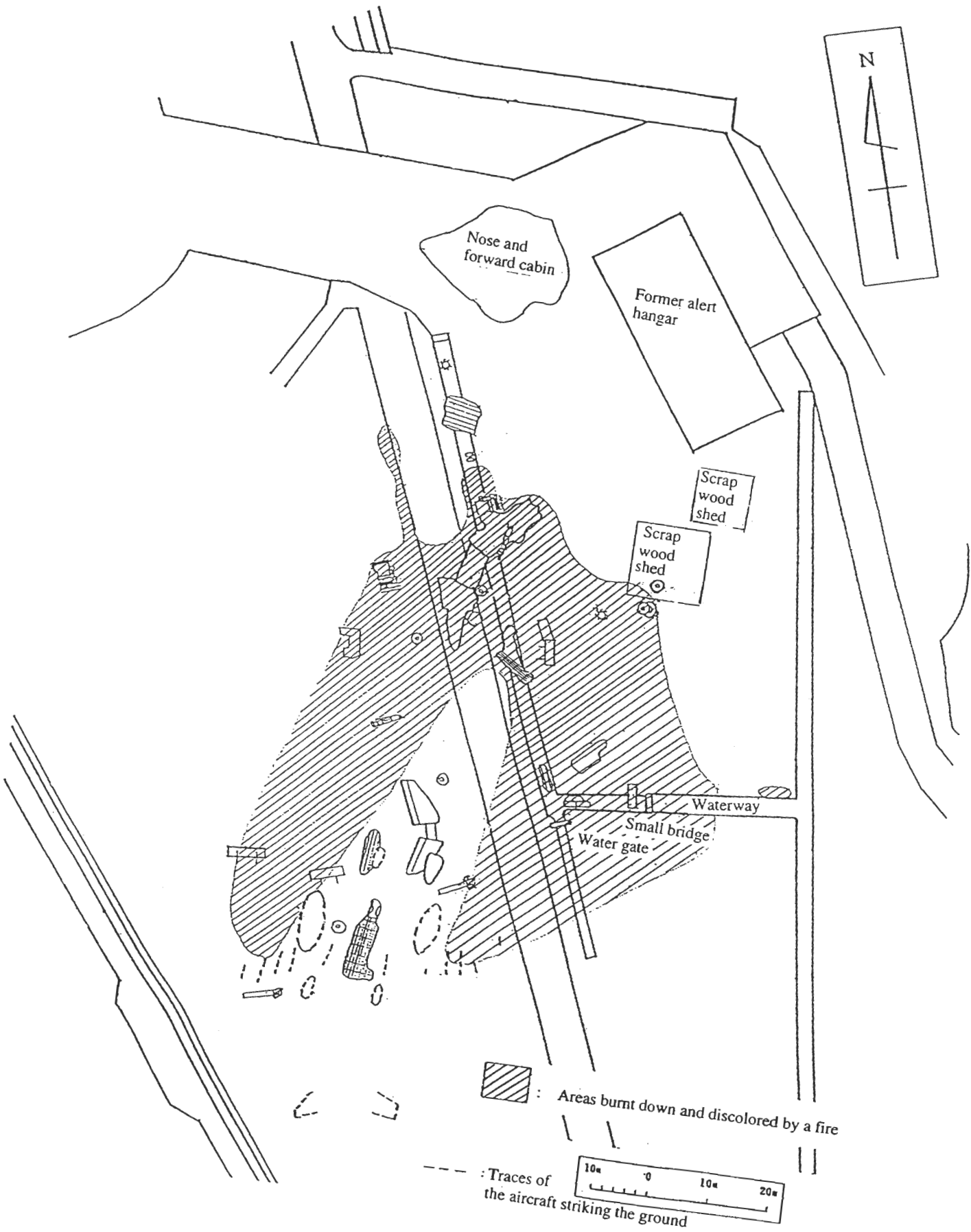

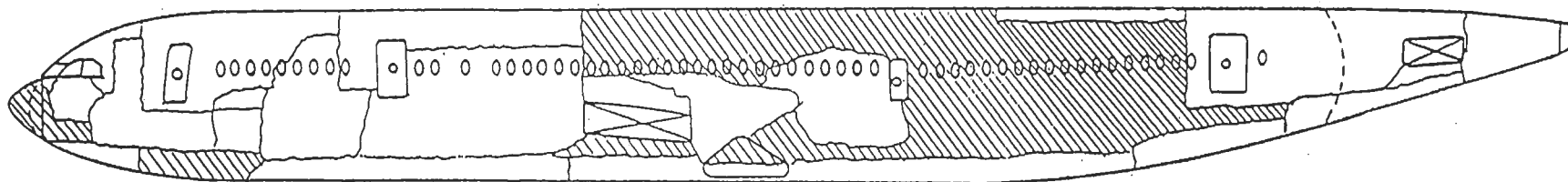

Attached Figure 13 State of Damage to Fuselage Skin

State of Breakage in Left Fuselage

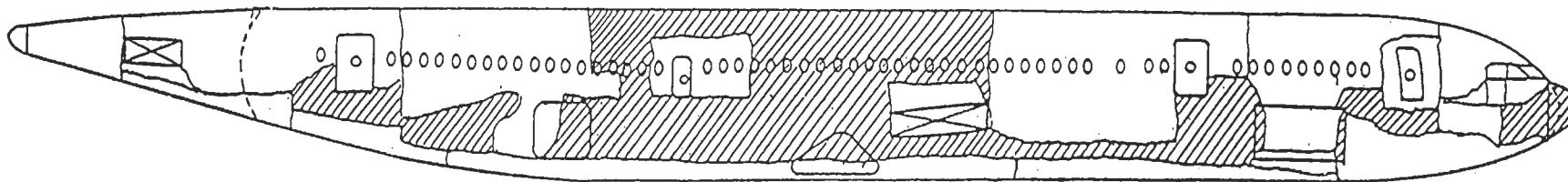

State of Breakage in Right Fuselage



-  : Broken areas
-  : Areas burnt down or destroyed by a fire or areas that could not be identified

Attached Figure 14 Airbus Industrie A300B4-622R Three Views

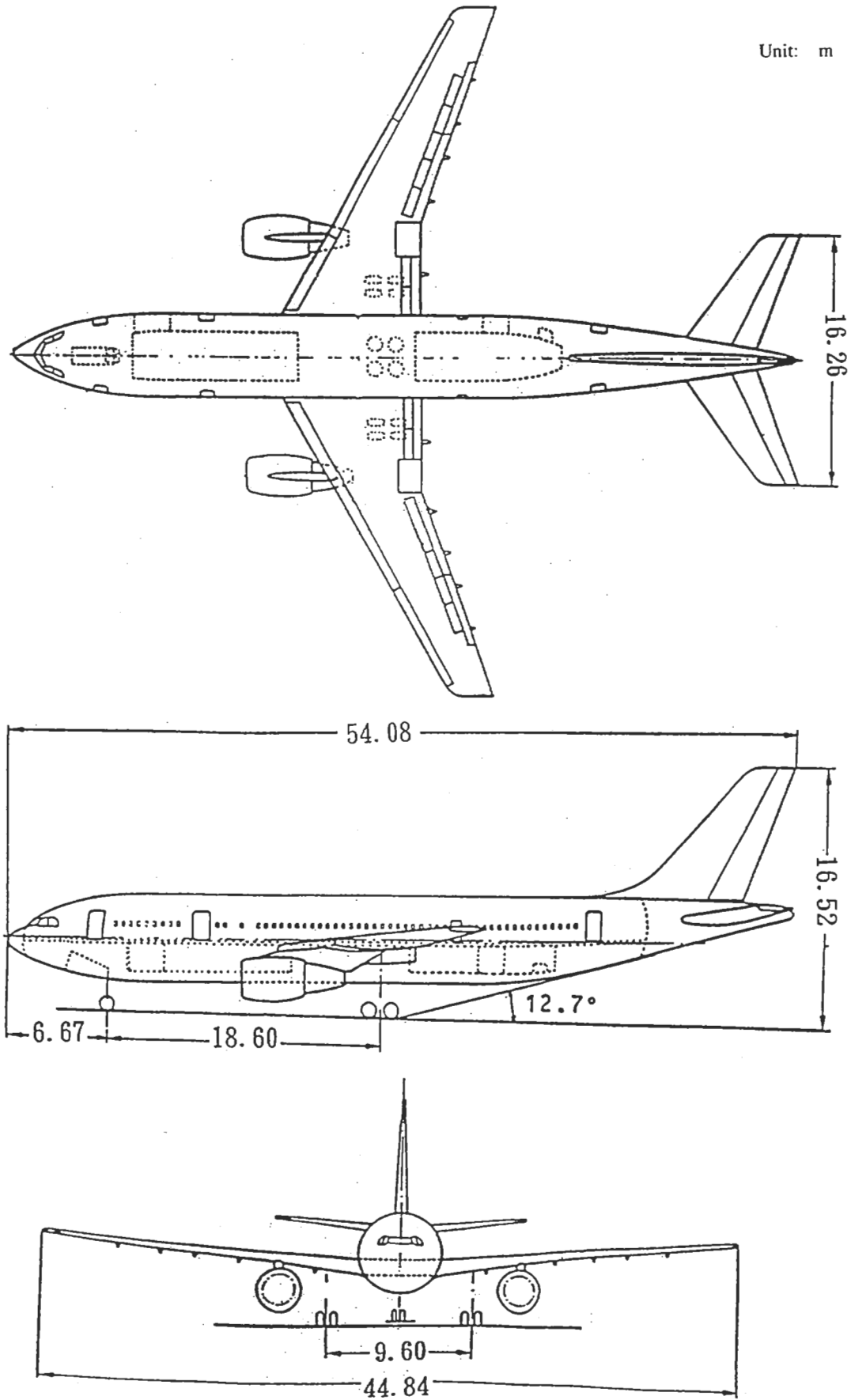

Attached Figure 15 Control Wing Section

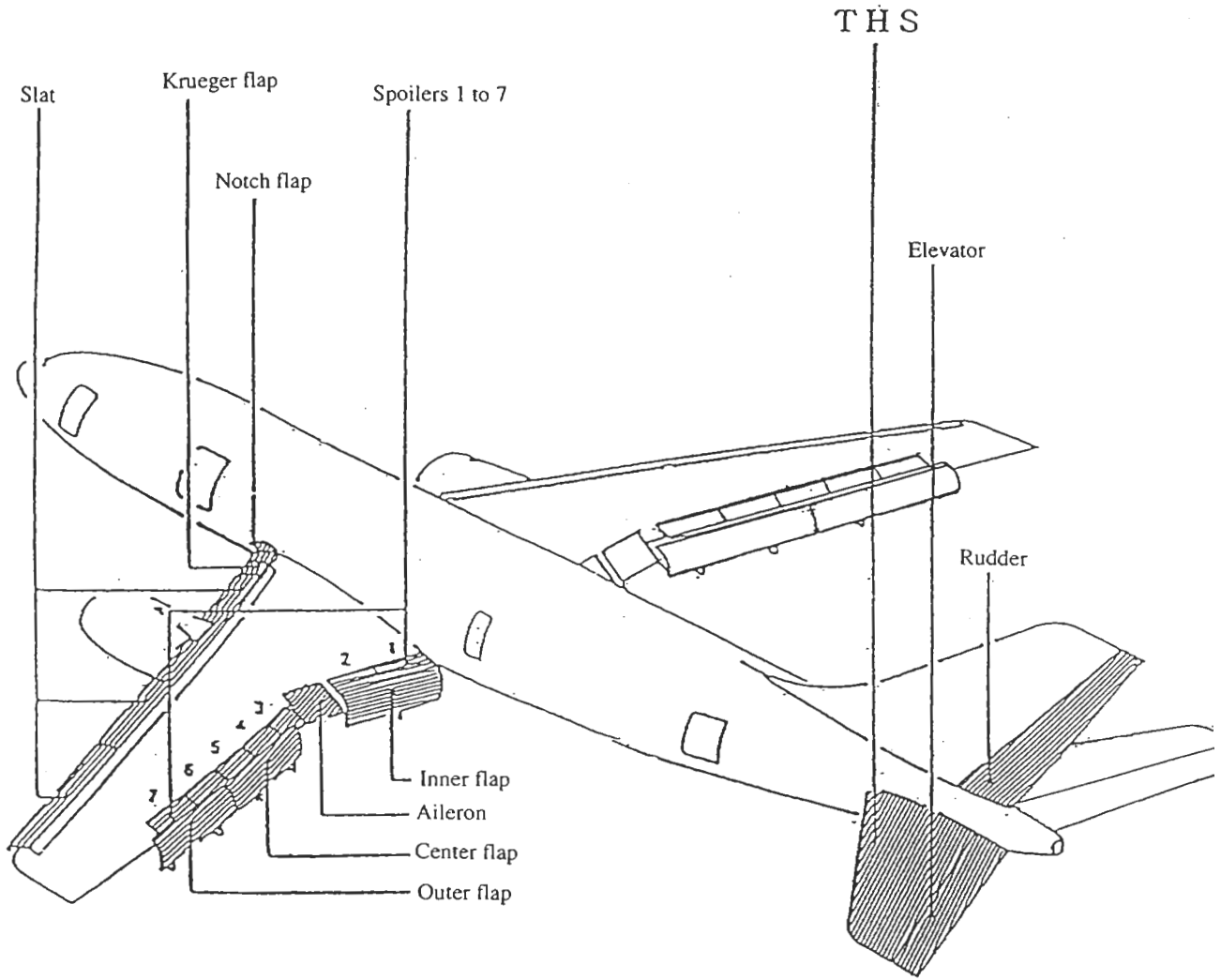

Attached Figure 16 Fuselage Stations-1

916

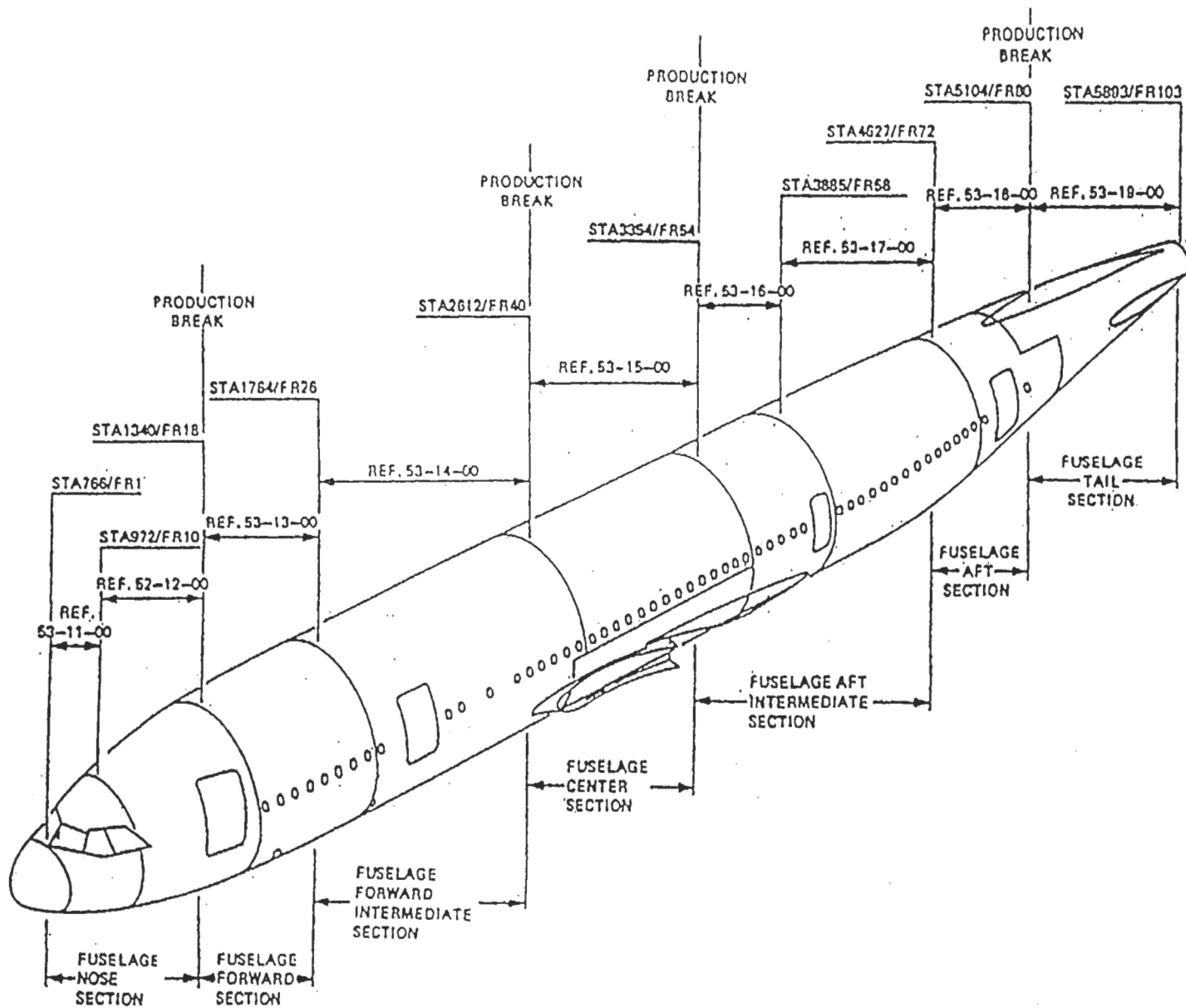

Attached Figure 17 Fuselage Stations-2

A17

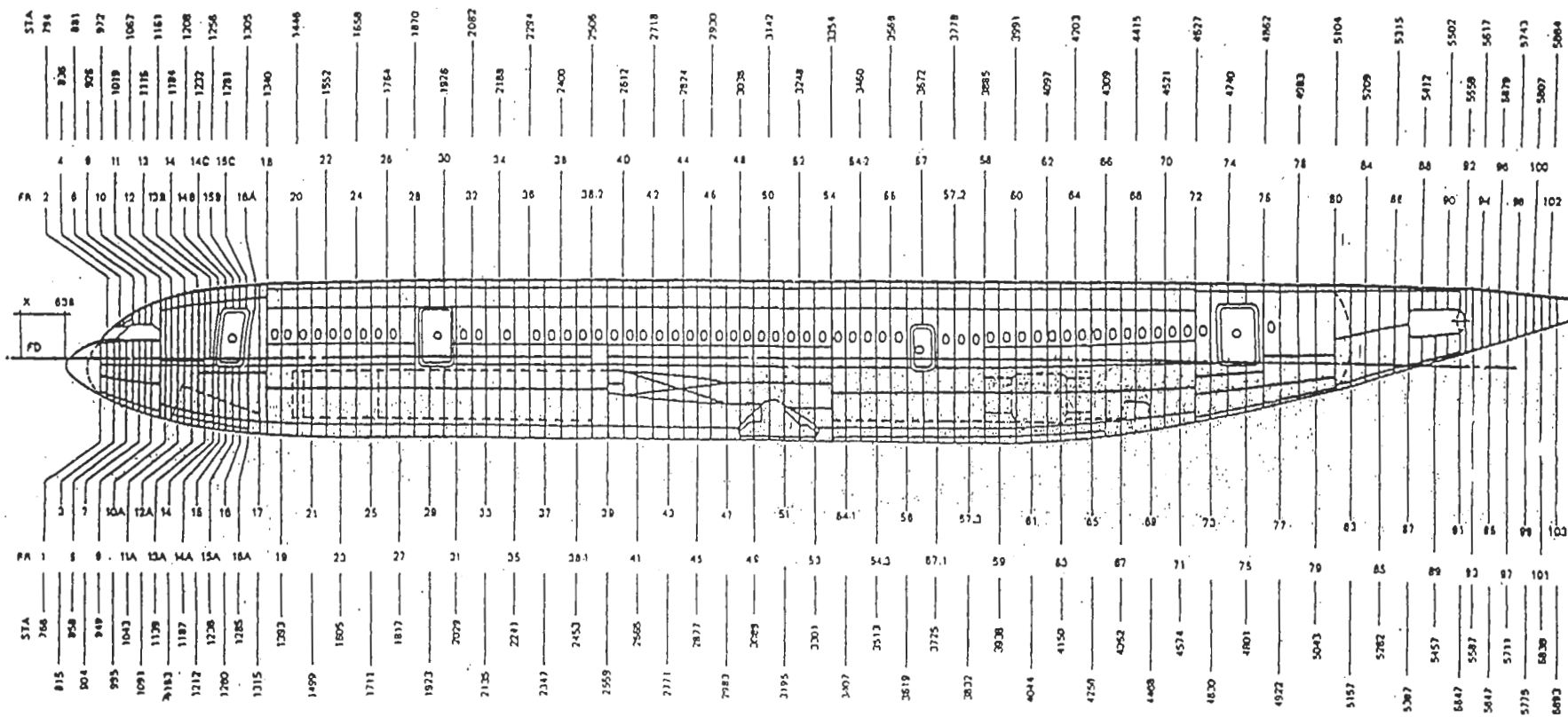

Attached Figure 18 Fuselage Stations-3

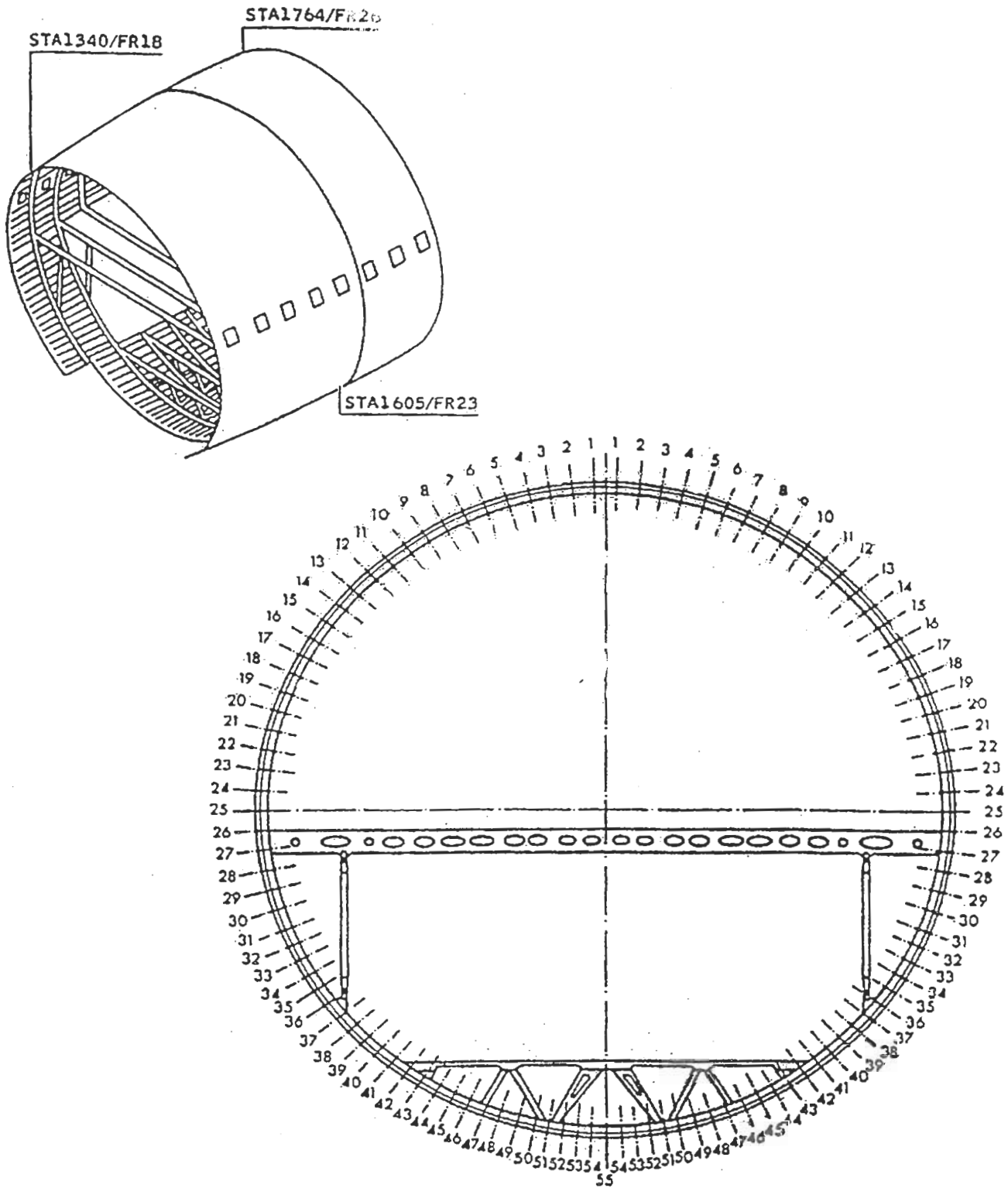

Attached Figure 19 Wing Stations

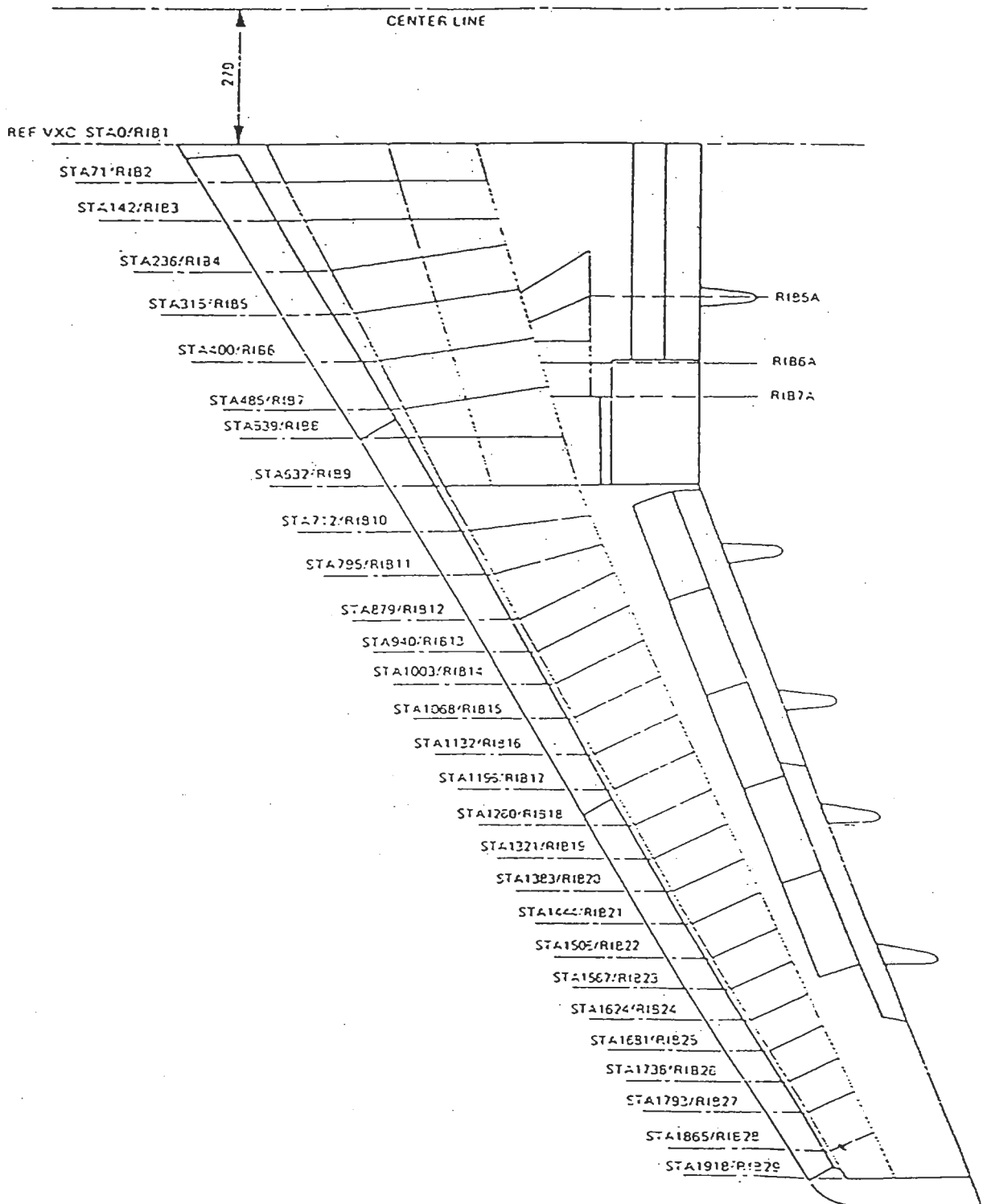

Attached Figure 20 Engine Sectional View (Pratt & Whitney model PW 4158)

A20

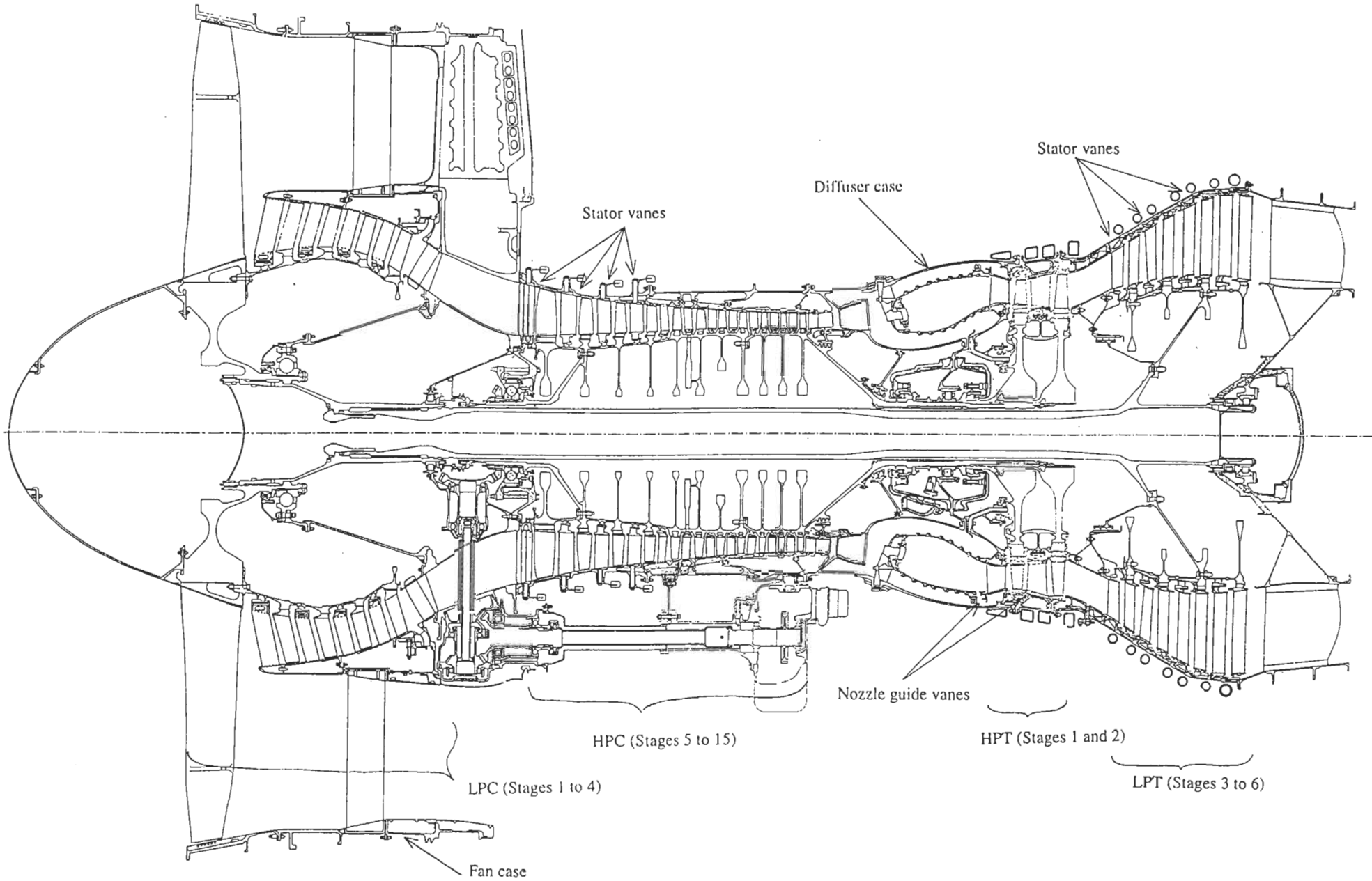

Attached Figure 21 Engine External Views

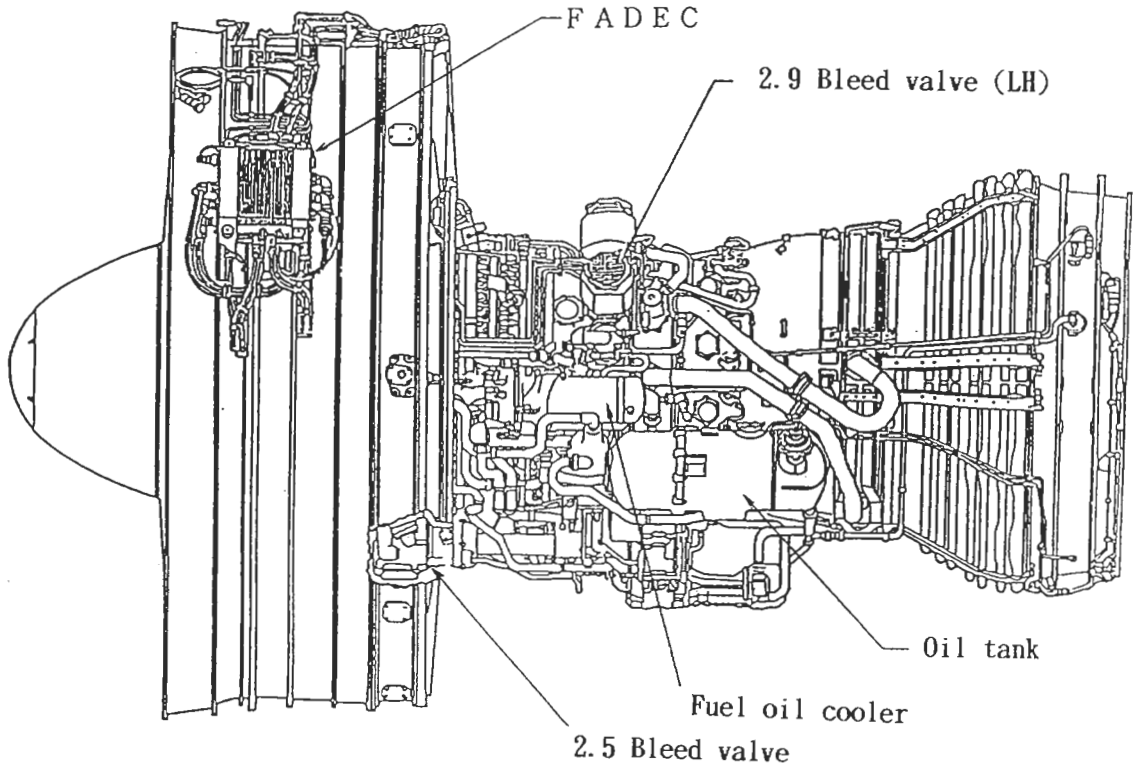

Engine External View (LH)

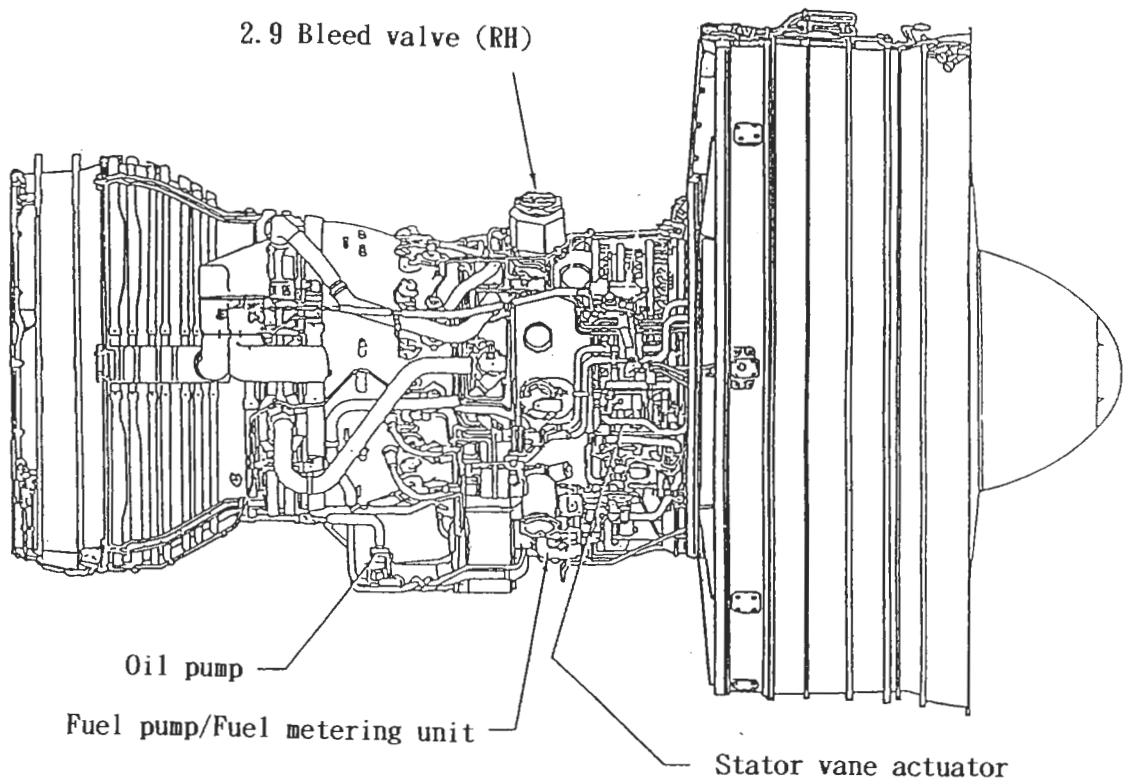

Engine External View (RH)

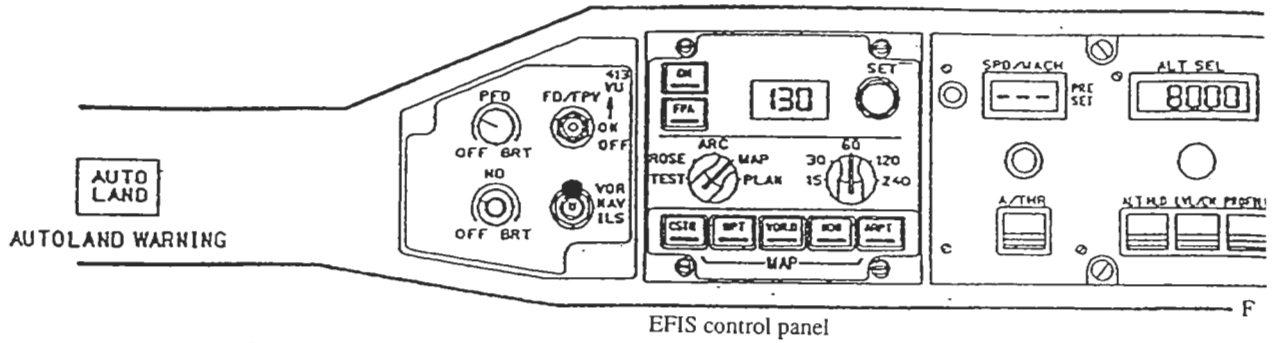

Pitch trim, yaw damper, ATS lever engage unit

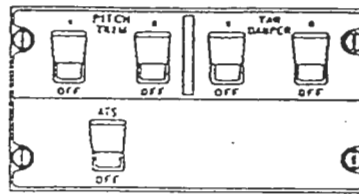

P F D

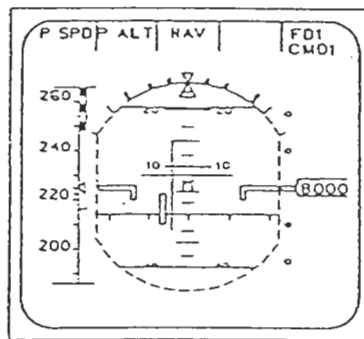

Master warning and caution lights

AP disconnect pushbutton switch

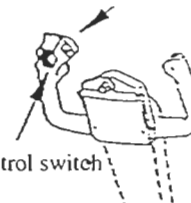

Pitch trim control switch

Captain's control wheel

AT disconnect pushbutton switch

GO lever

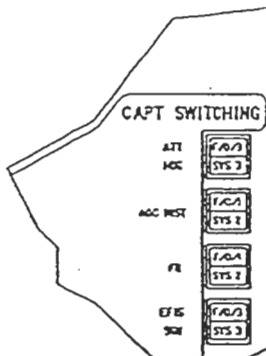

Captain's instrument switching

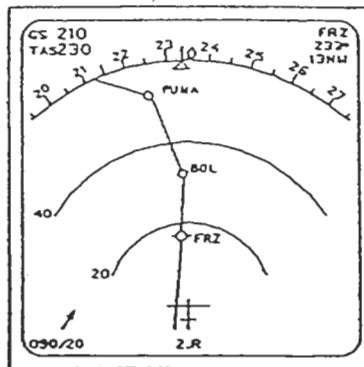

Navigation display

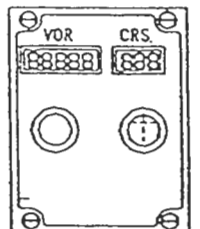

VOR

Displays, and Indicators in Cockpit

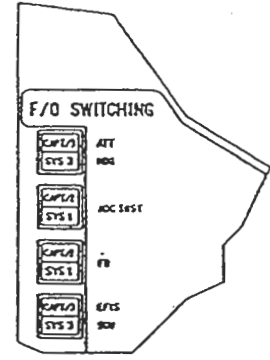
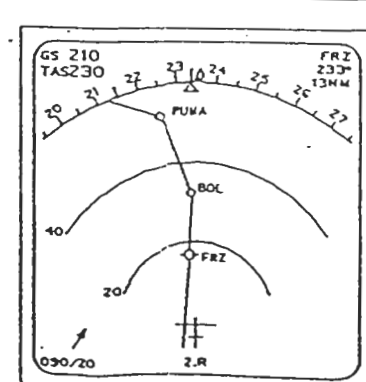
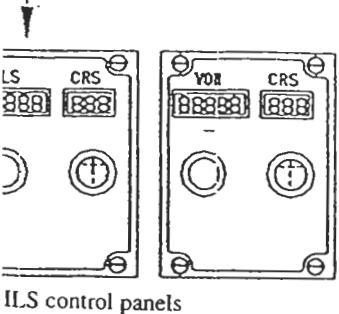
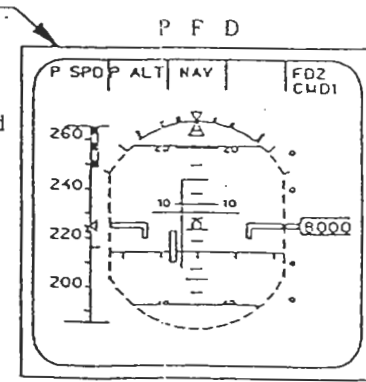
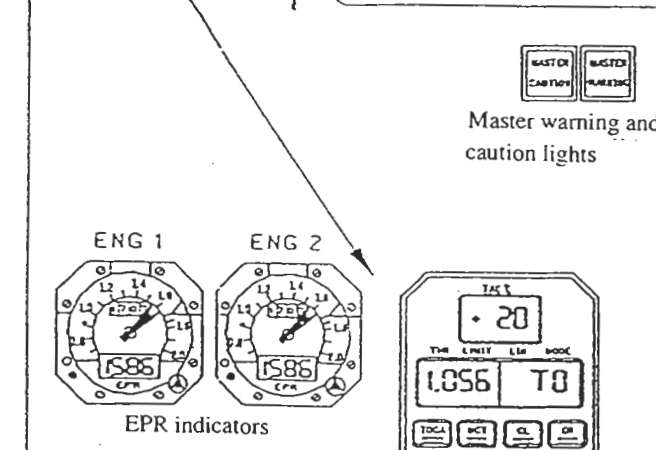
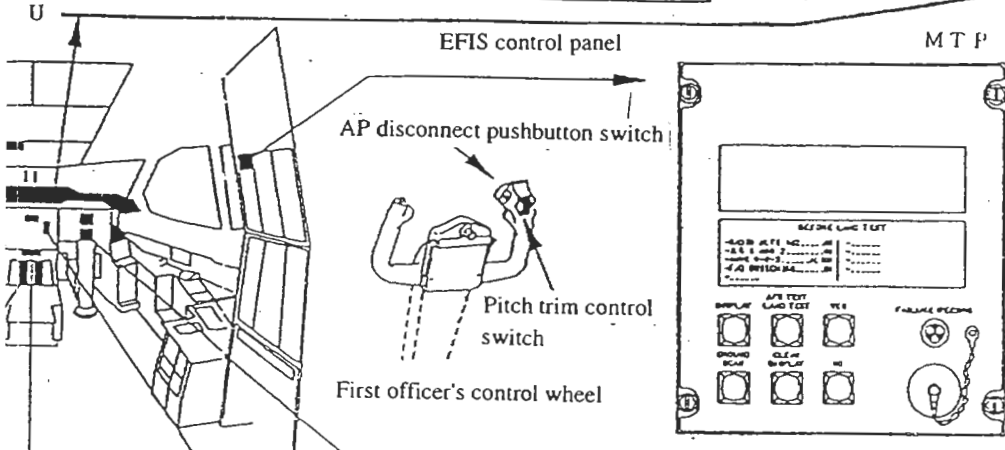
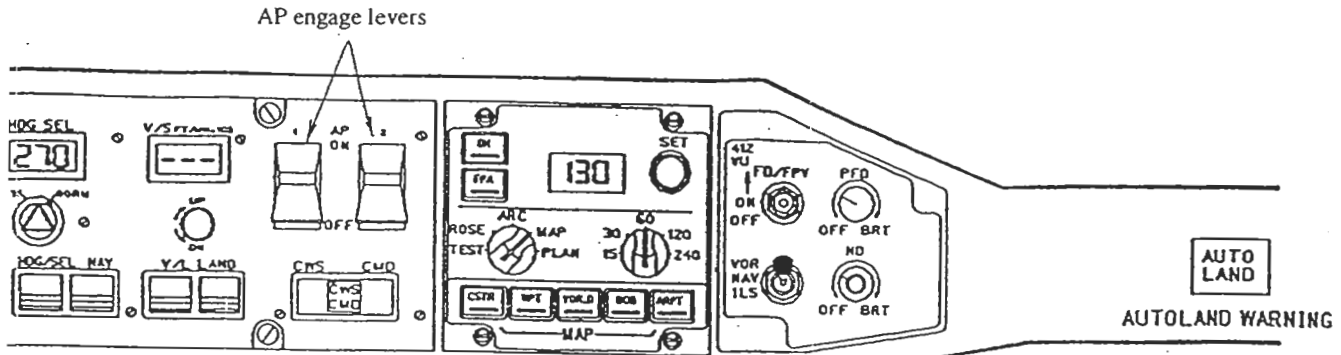

First officer's instrument switching

Attached Figure 23 Layout of Lighting Switches in Cockpit

A: COCPIT LT PANEL

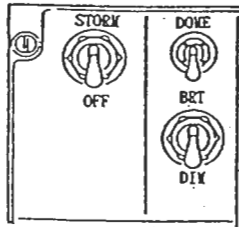

B: OVERHEAD PANEL
READING LT KNOB



C: ANN LT AND STBY COMPASS PANEL

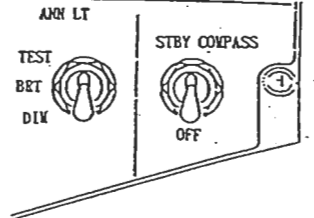

I: AUTO TEST PANEL



D: GLARSHIELD LIGHTING CONTROL

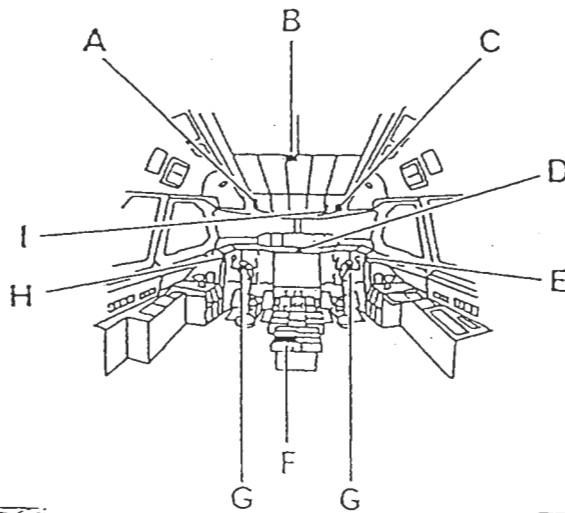

H: CAPT AND CENTER LT PANEL

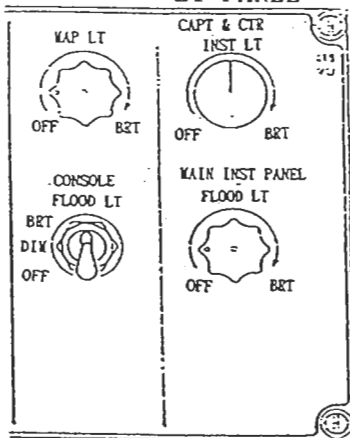

E: FO LT PANEL

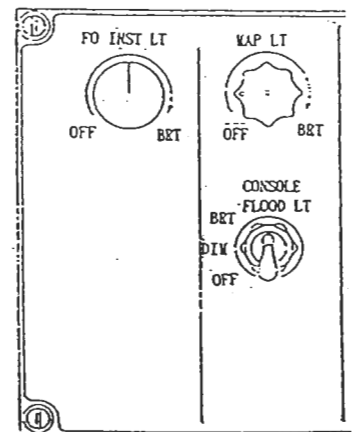

G: CHART HOLDER LT KNOB

F: PED AND OVERHEAD PANEL LT CONTROL

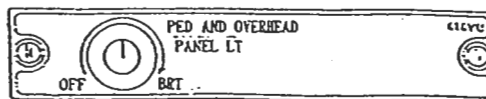

Attached Figure 24 External View of Pilot's Seat

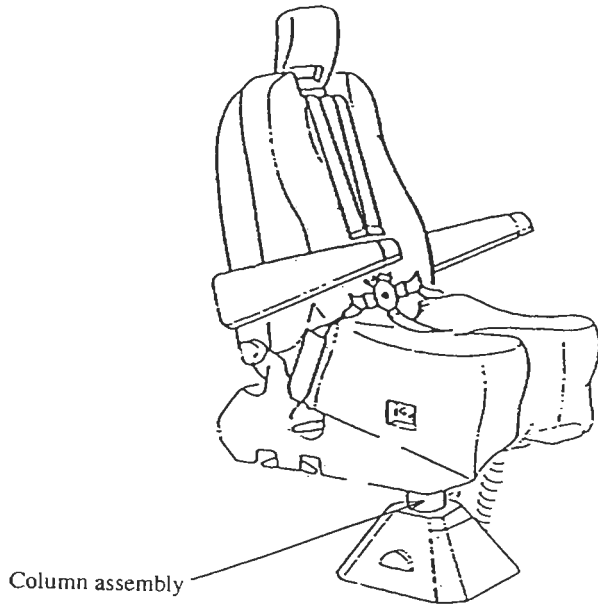

Seat External View

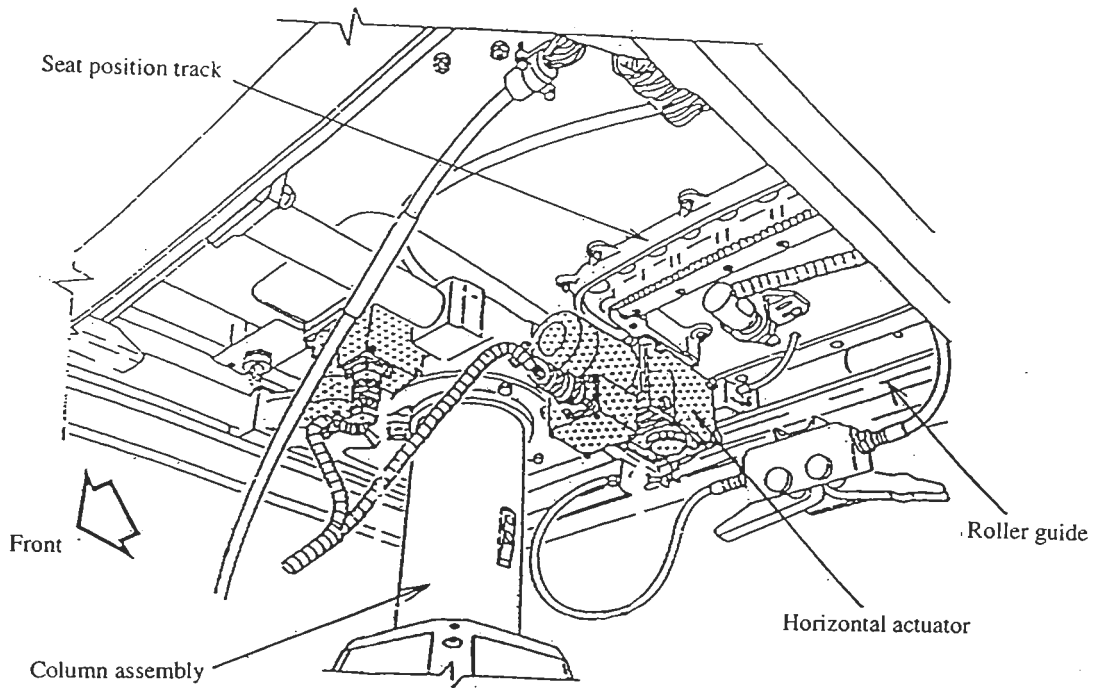

Oblique View of Bottom Surface of Seat

Attached Figure 25 Set Positions of Captain's and First Officer's Seats

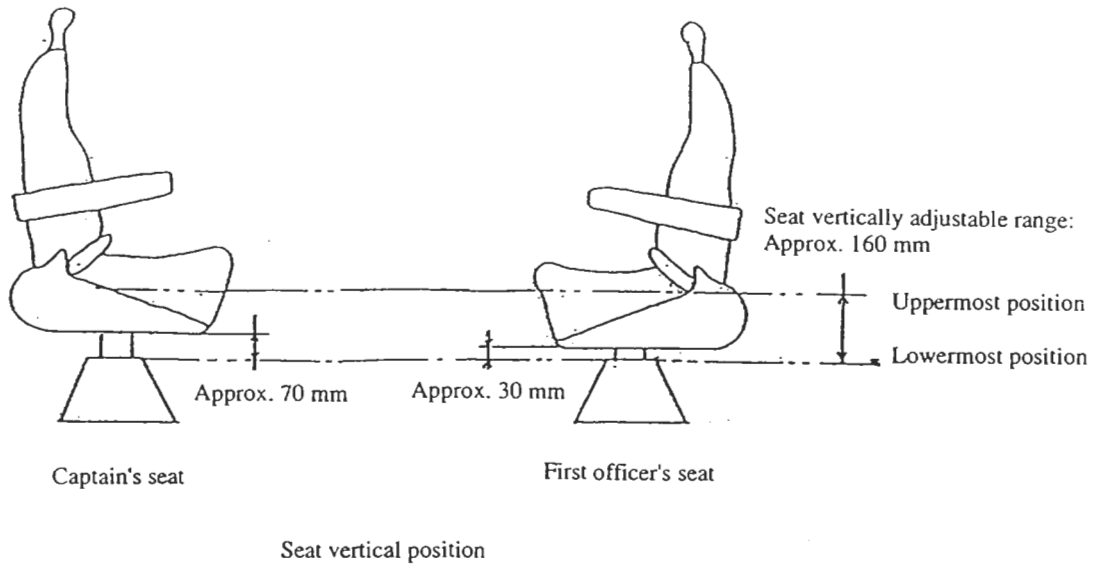
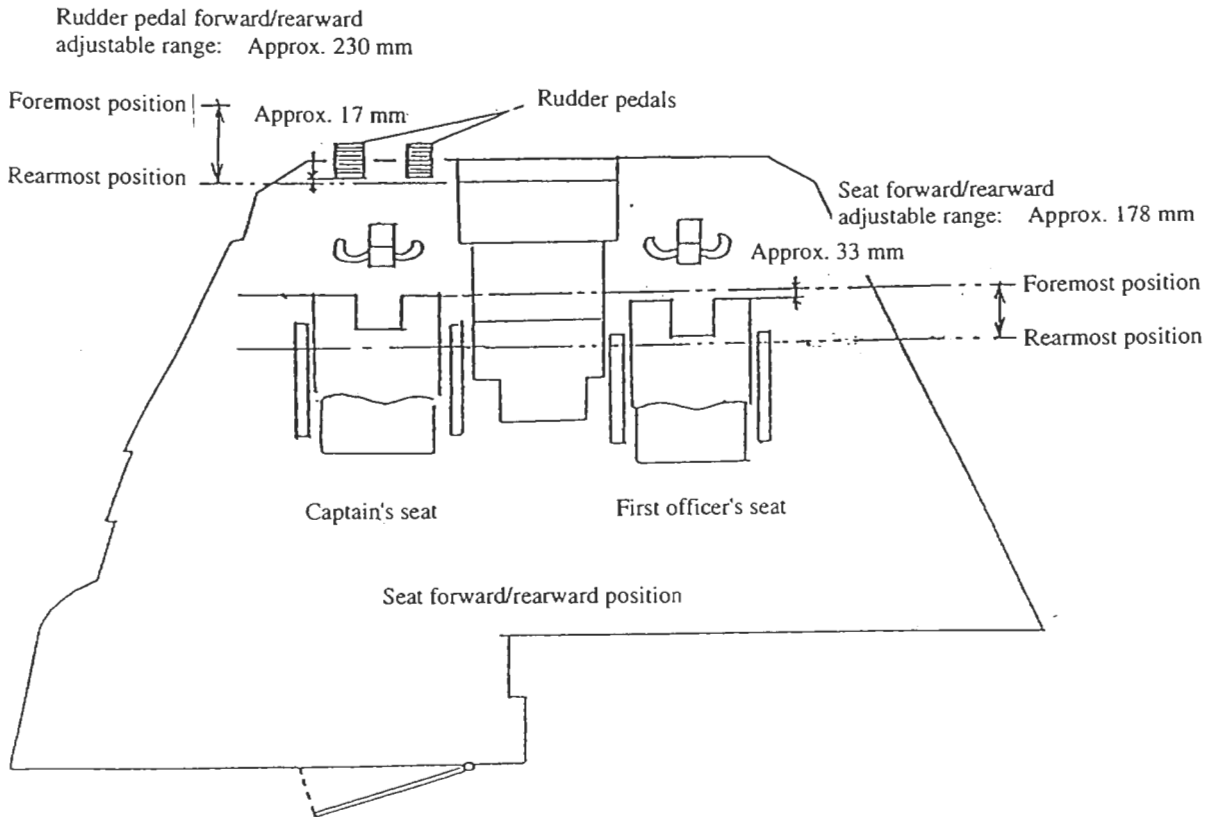

Attached Figure 26 Seat Arrangement Chart

- A ATTENDANT SEAT (12x)
- B BUSTLE (1x)
- C COAT STOWAGE (2x)
- D DOGHOUSE (5x)
- G GALLEY (4x)
- L LAVATORY (6x)

A27

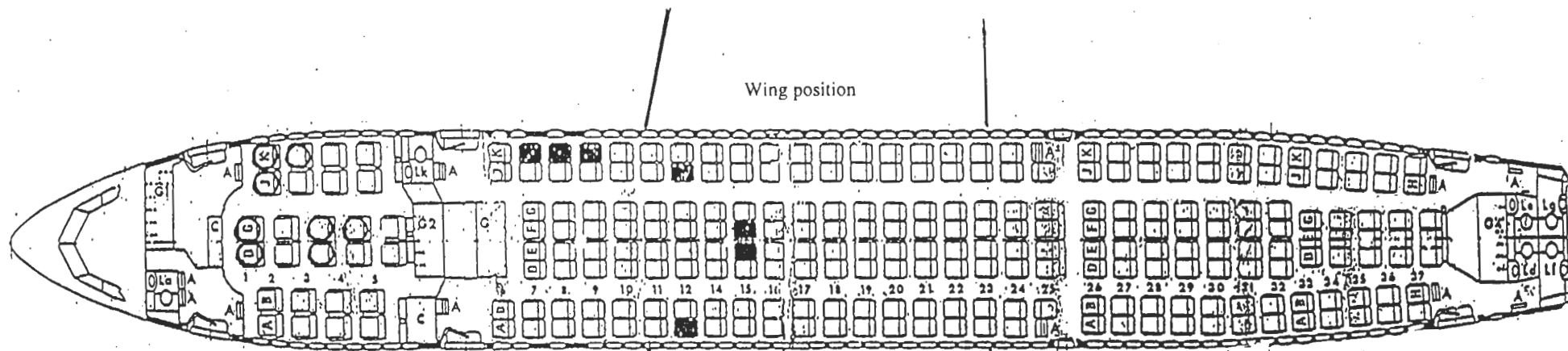

✱ ■ seats occupied by survivors.

○ seats were not occupied. The rest of seats were occupied by the deceased.

Attached Figure 27 Sketch of SLATS/FLAPS Control Lever Gate and Balk

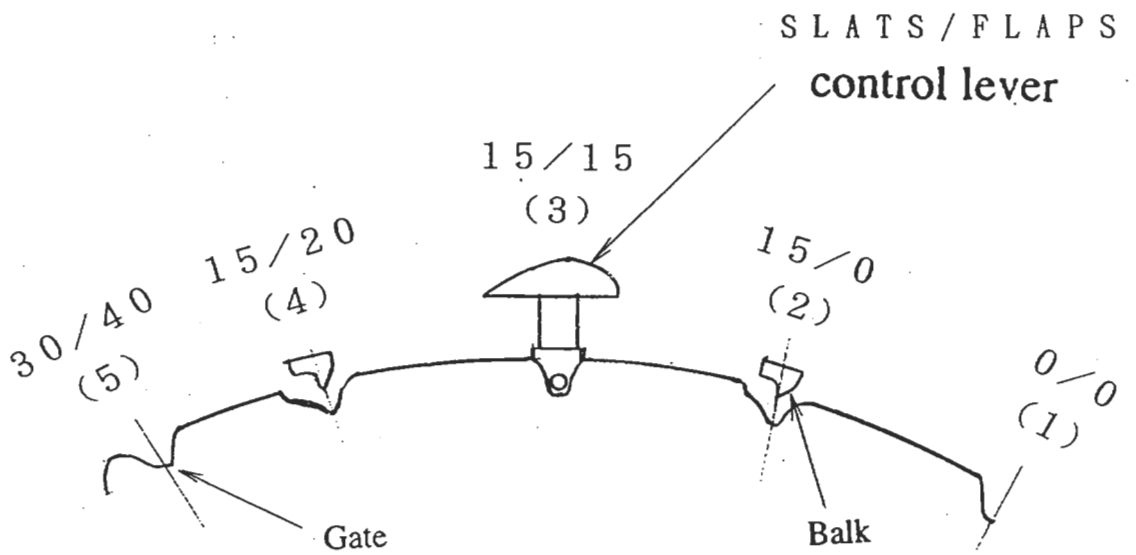
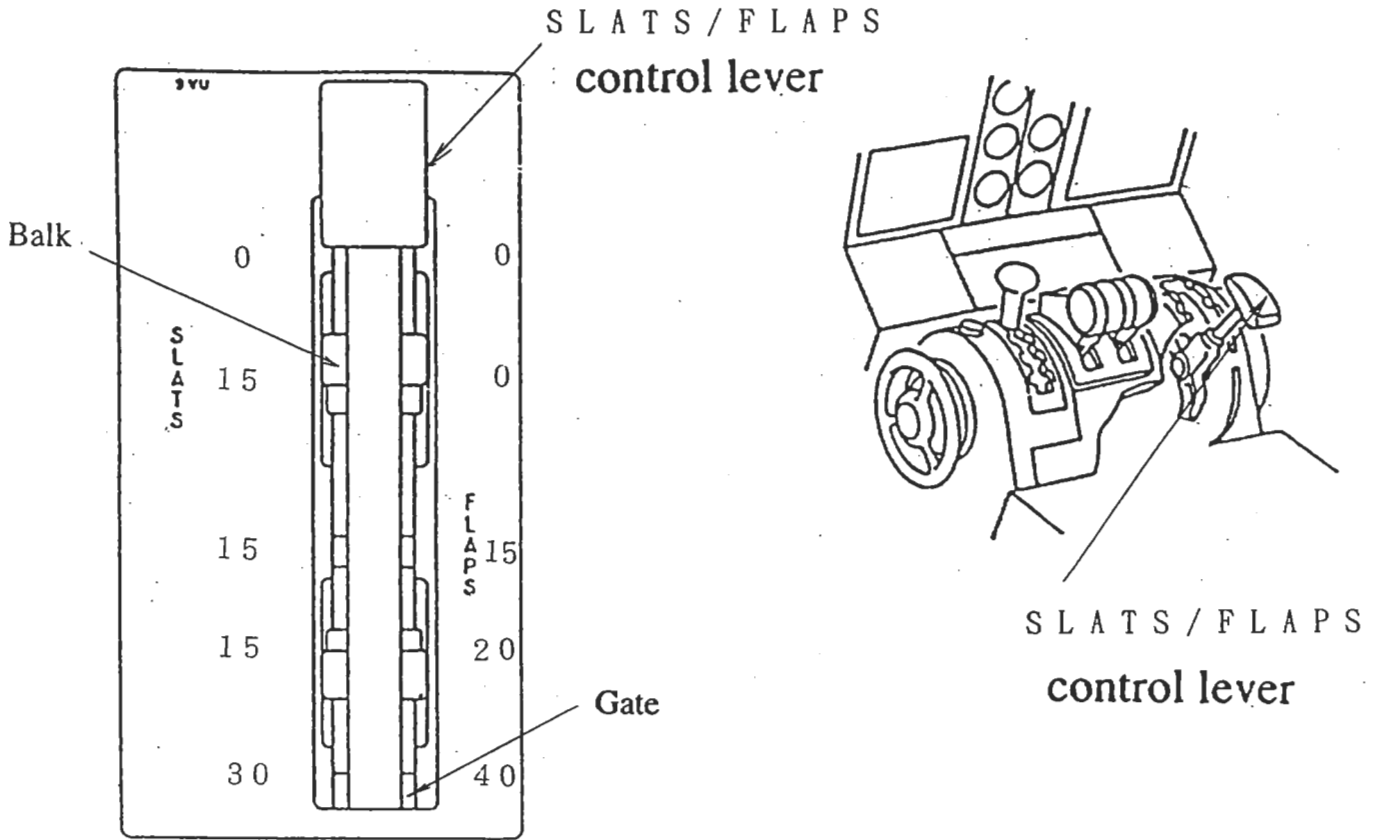

SLATS/FLAPS Control Lever Positions

Attached Figure 28 Operation of THS
(Record of DFDR)

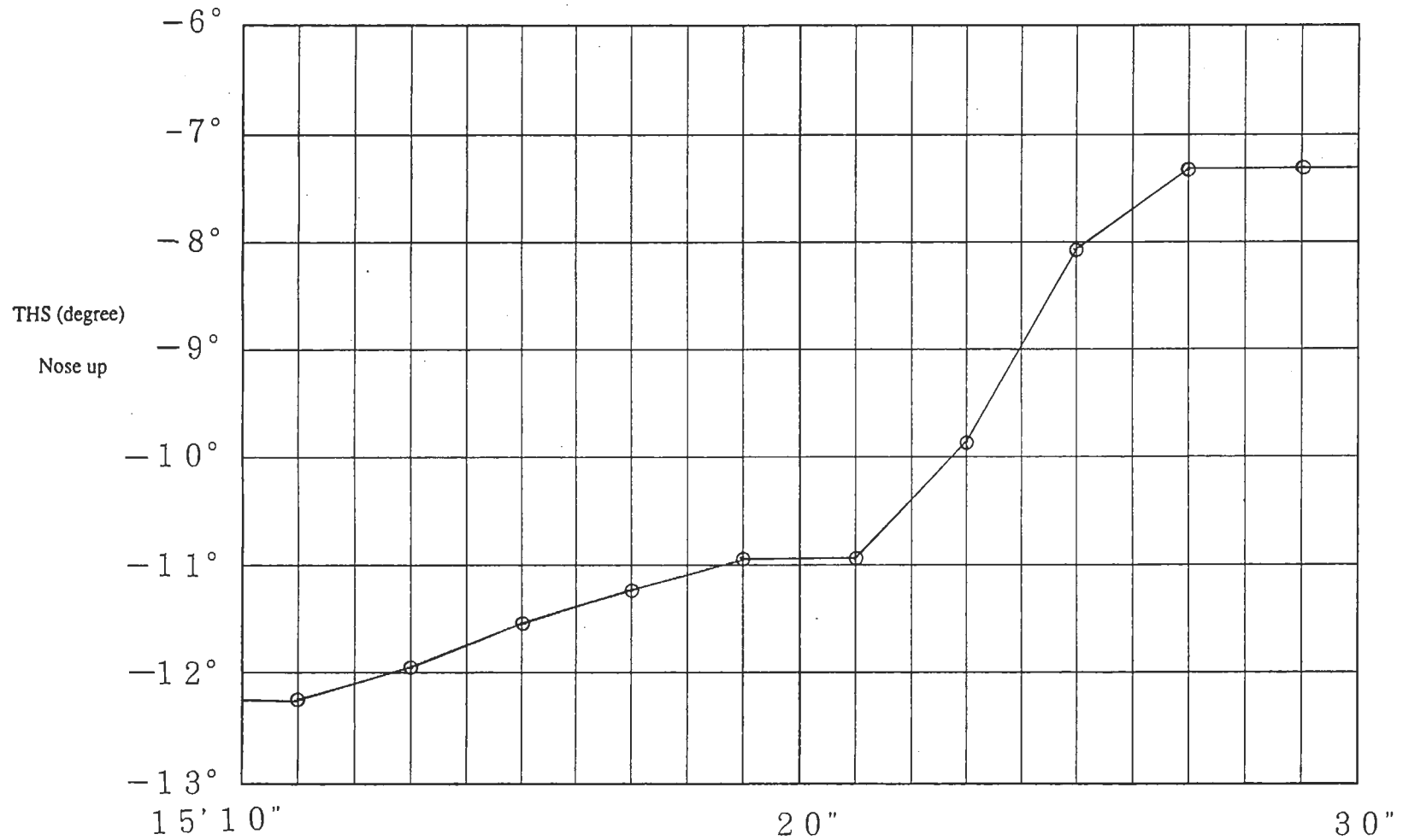

A29

Attached Figure 29 Assumed FMA Displays

14' 00" : During normal ILS approach

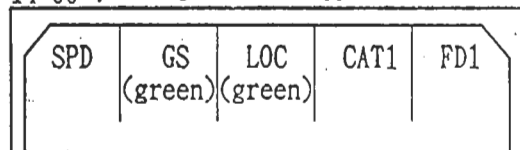

14' 48" : Autopilot disengaged by manual thrust

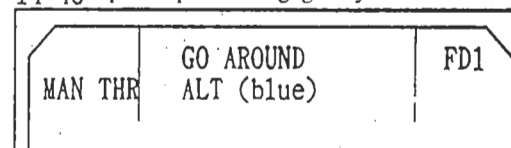

14' 06" : GO lever hit

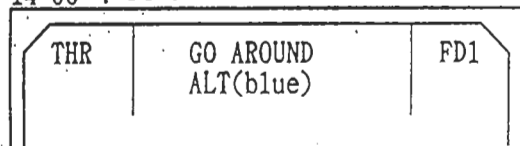

15' 02" : Alpha-floor operated; thrust lever latched

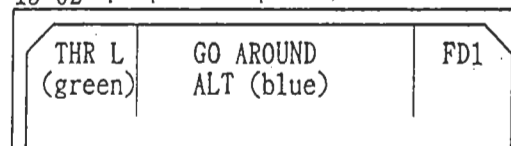

14' 12" : Auto thrust disengaged

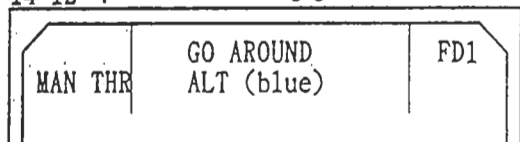

15' 11" : Captain relieved first officer at the controls to increase thrust.

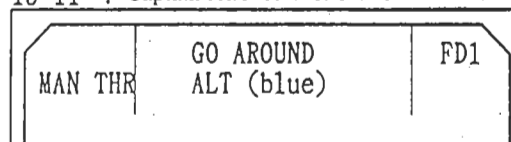

14' 18" : Autopilot No.2/No.1 ON by manual thrust

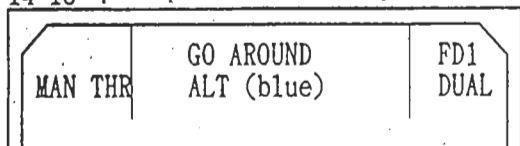

15' 13" : Pitch angle became 25.84°. (See Note.)

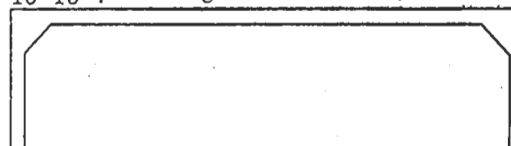

Note: According to FCOM 1.10.30 P2, if pitch angle exceeds 25° or -13°, all the PFDs except those of attitude, speed, and heading will disappear, and when pitch angle is within 22° or -10°, normal displays will be restored to.

Photo.1 Site Where the Accident Occurred

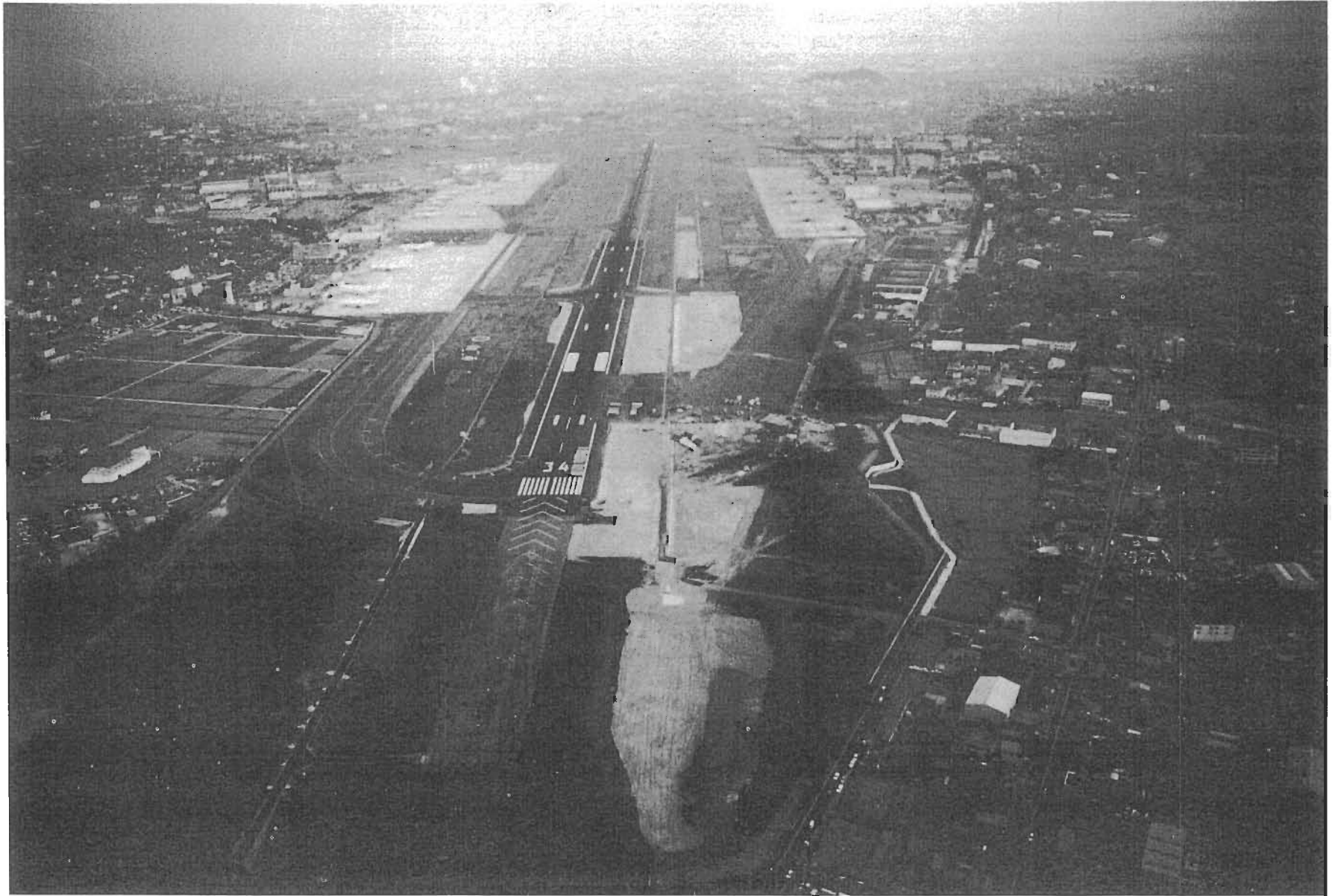
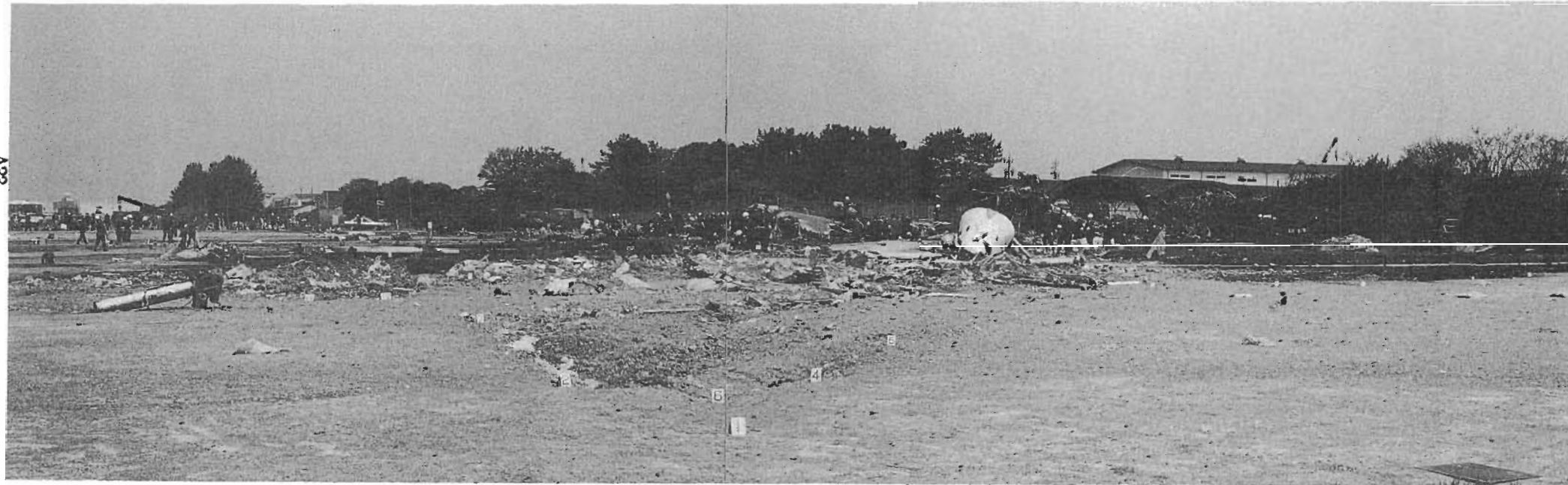

Photo.2 Site Where the Accident Occurred and Its Vicinity



A52

Photo.3 Whole Scene of the Crash Site



A33

Photo.4 Rescue Activities



Photo.5 Left Aileron



Photo.6 Right Aileron

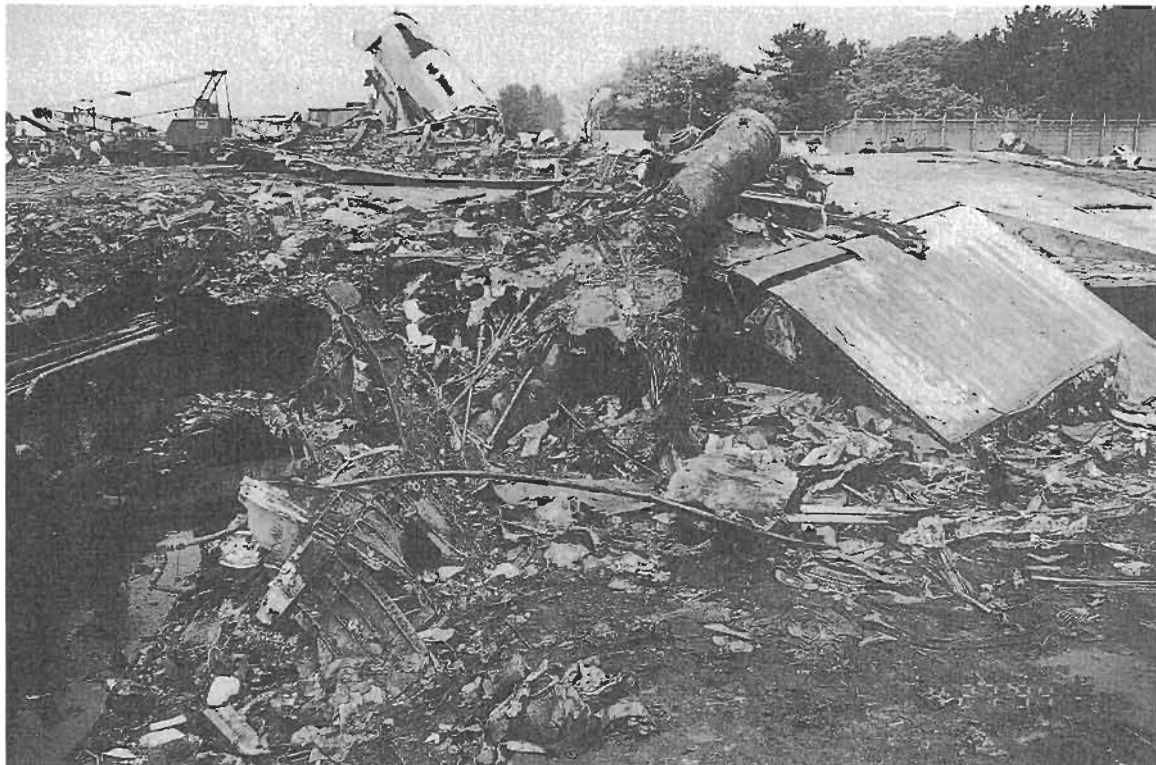

Photo.7 Right No.6 Spoiler and Left No.7 Spoiler

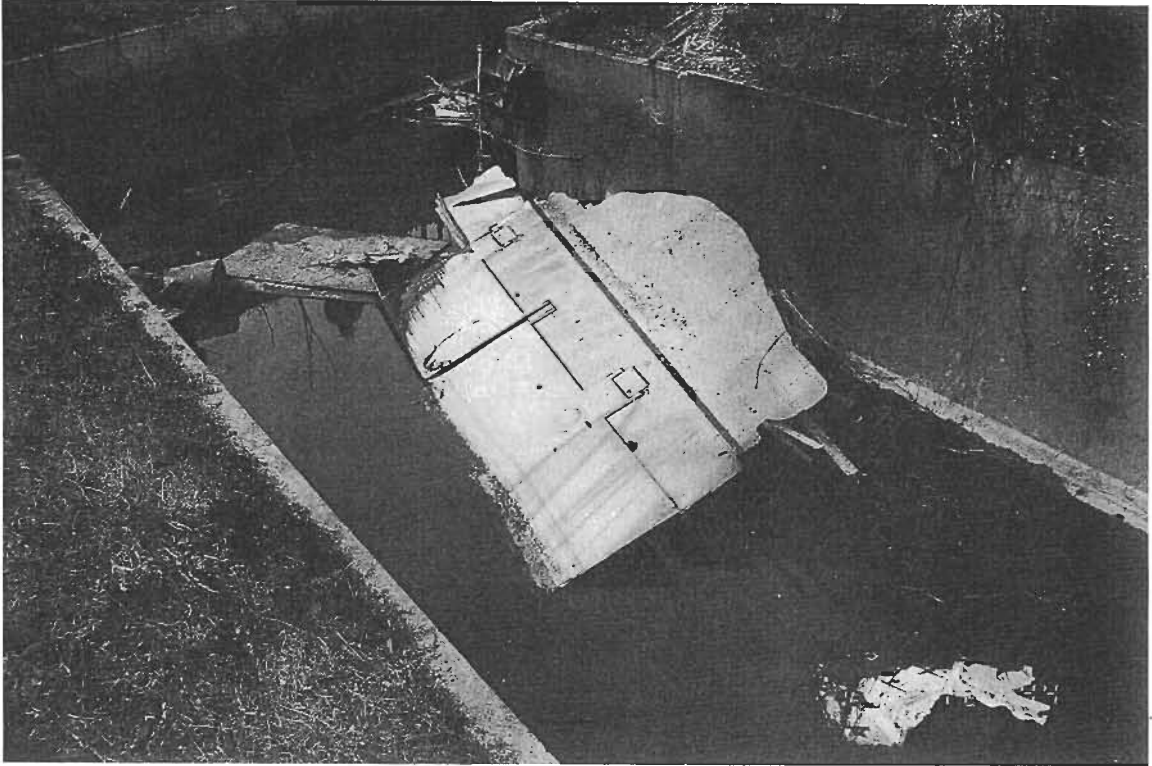

Photo.8 Vertical Stabilizer and Rudder



Photo.9 Left Elevator



Photo.10 Right Elevator



Photo.11 THS



Photo.12 THS Screw Jack

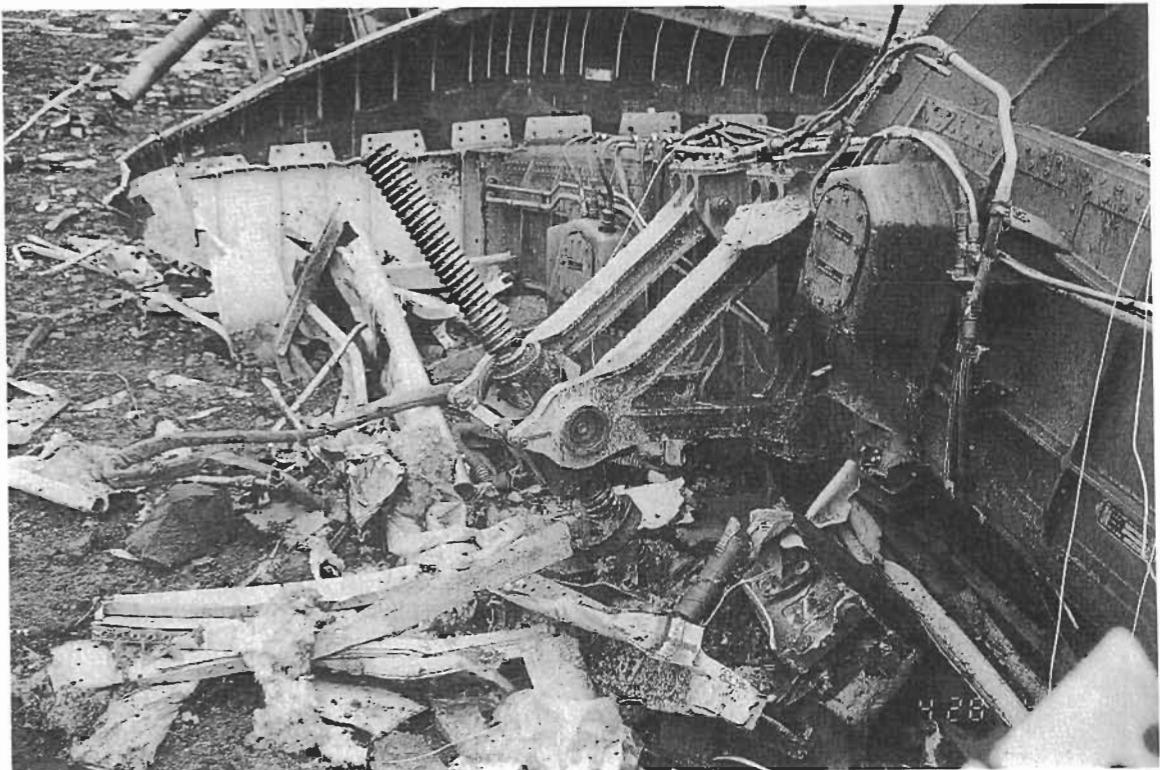

Photo.13 Left Center Flap

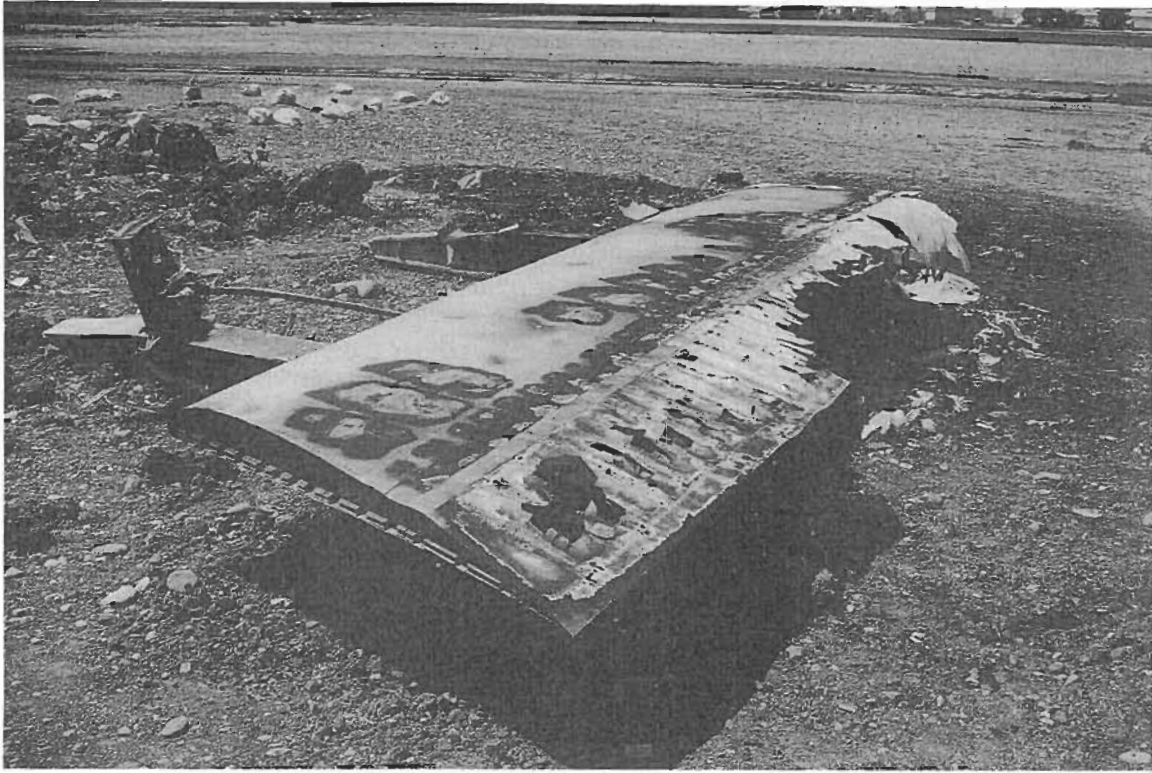

Photo.14 Left Flap's No.3 Screw Jack

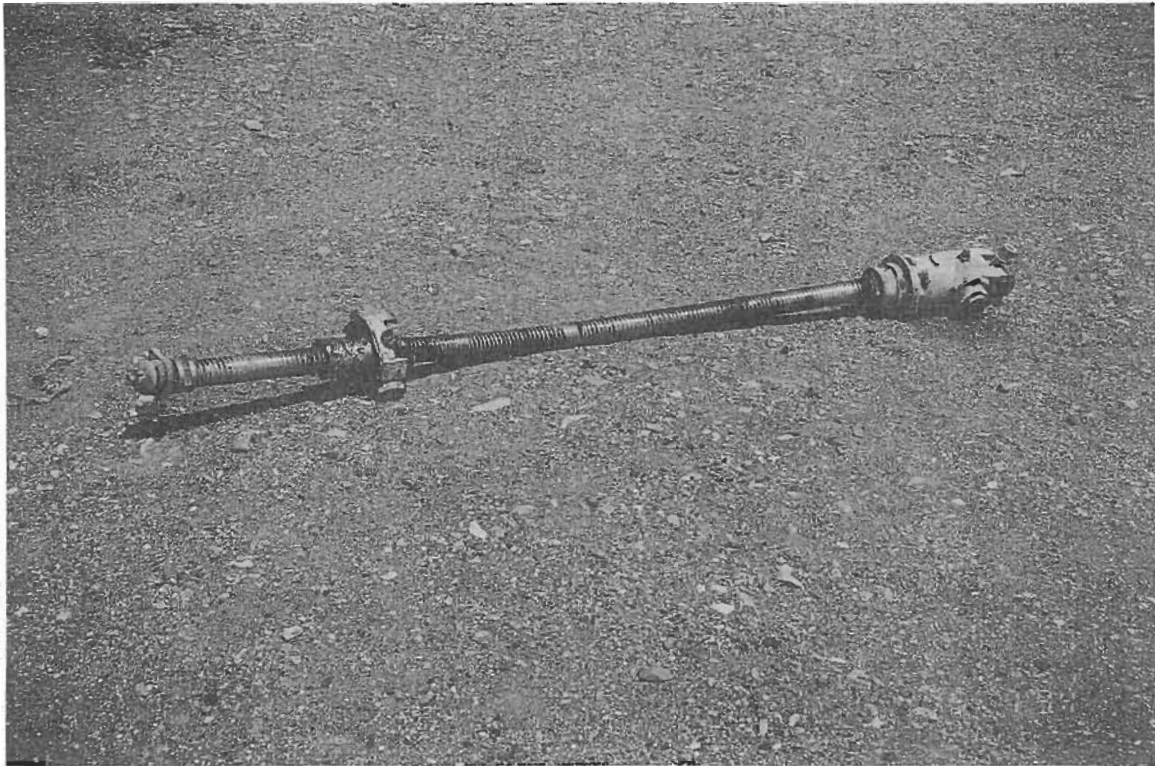

Photo.15 Right Flap's No.2 Track

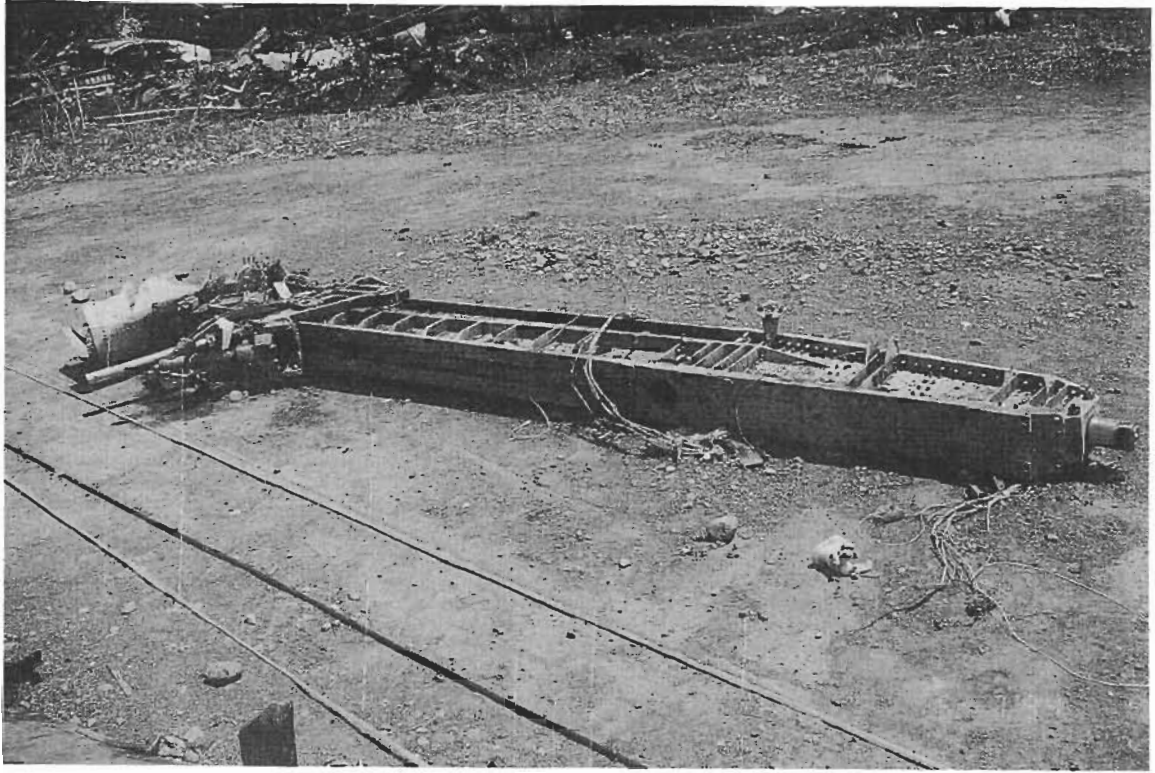

Photo.16 Right Center Flap

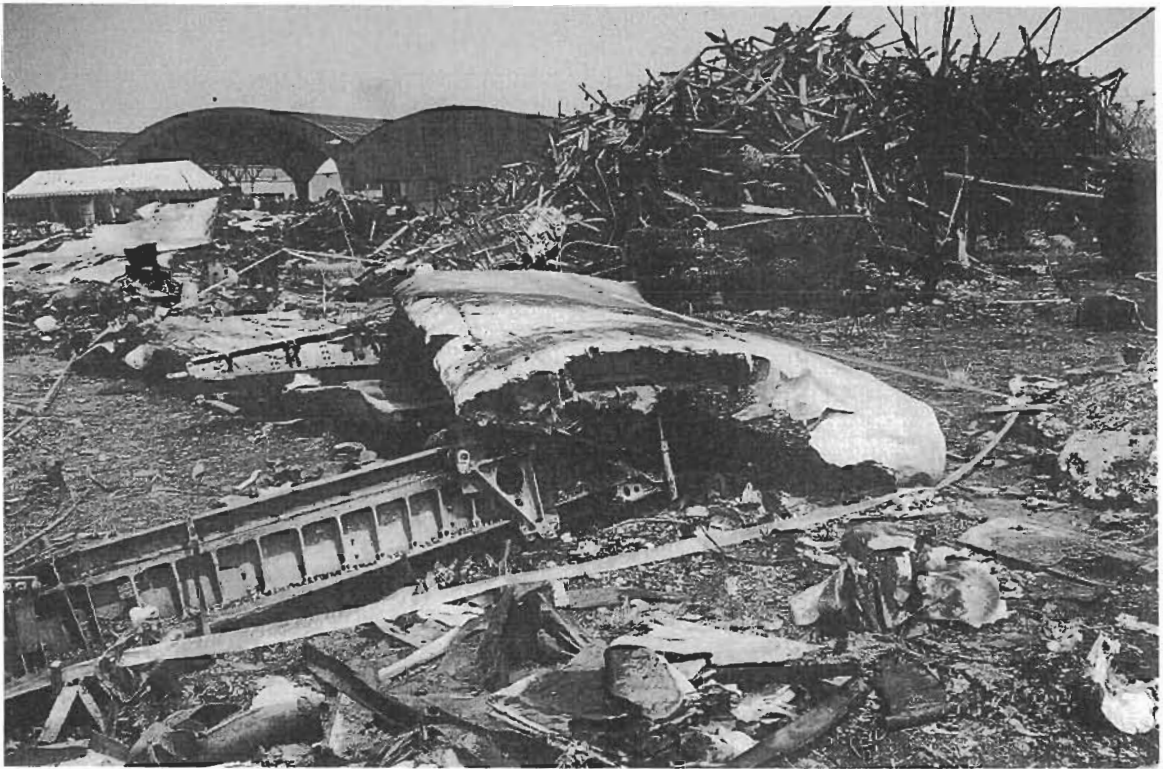

Photo.17 Left Outer Slat



Photo.18 Right Outer Slat

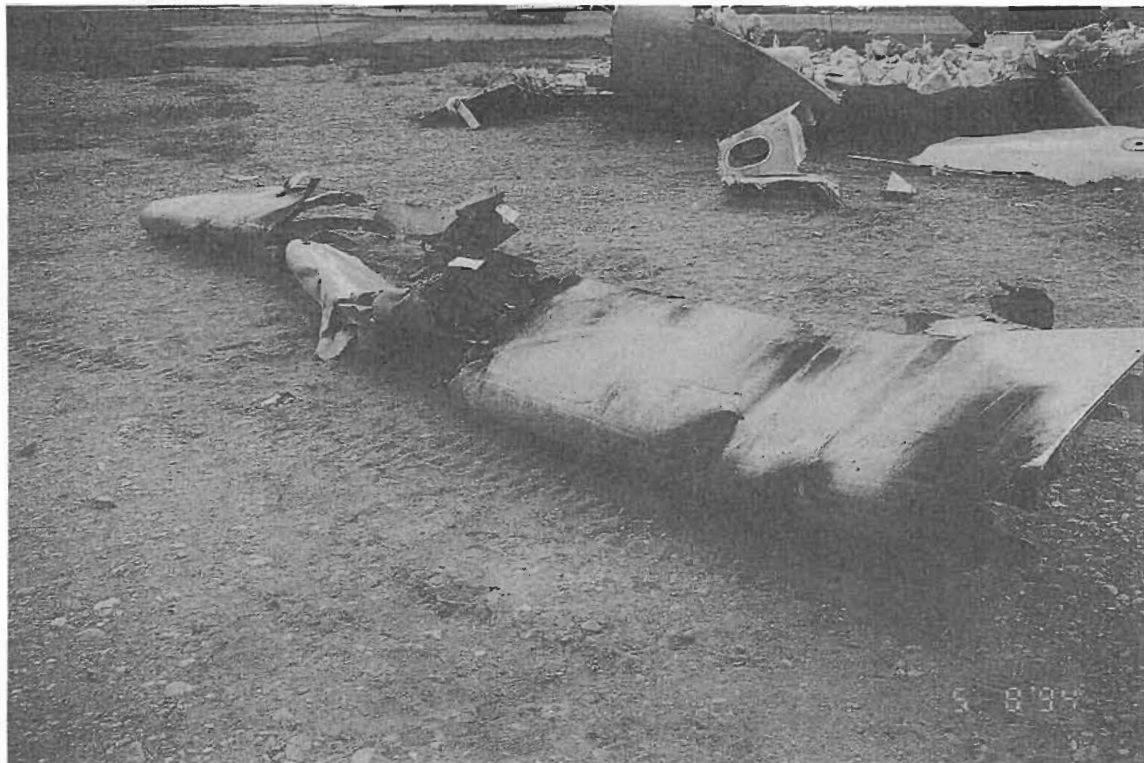

Photo.19 Left Wing



Photo.20 Fractures of the Right Wing



Photo.21 Shock Absorber of the Left Main Landing Gear



Photo.22 Tire and Brake Assembly of the Left Main Landing Gear



Photo.23 Shock Strut of the Right Main Landing Gear



Photo.24 Tires of the Right Main Landing Gear



Photo.25 Leg Assembly of the Nose Landing Gear



Photo.26 Tires of the Nose Landing Gear



Photo.27 Front Windows and Upper Surface of the Cockpit

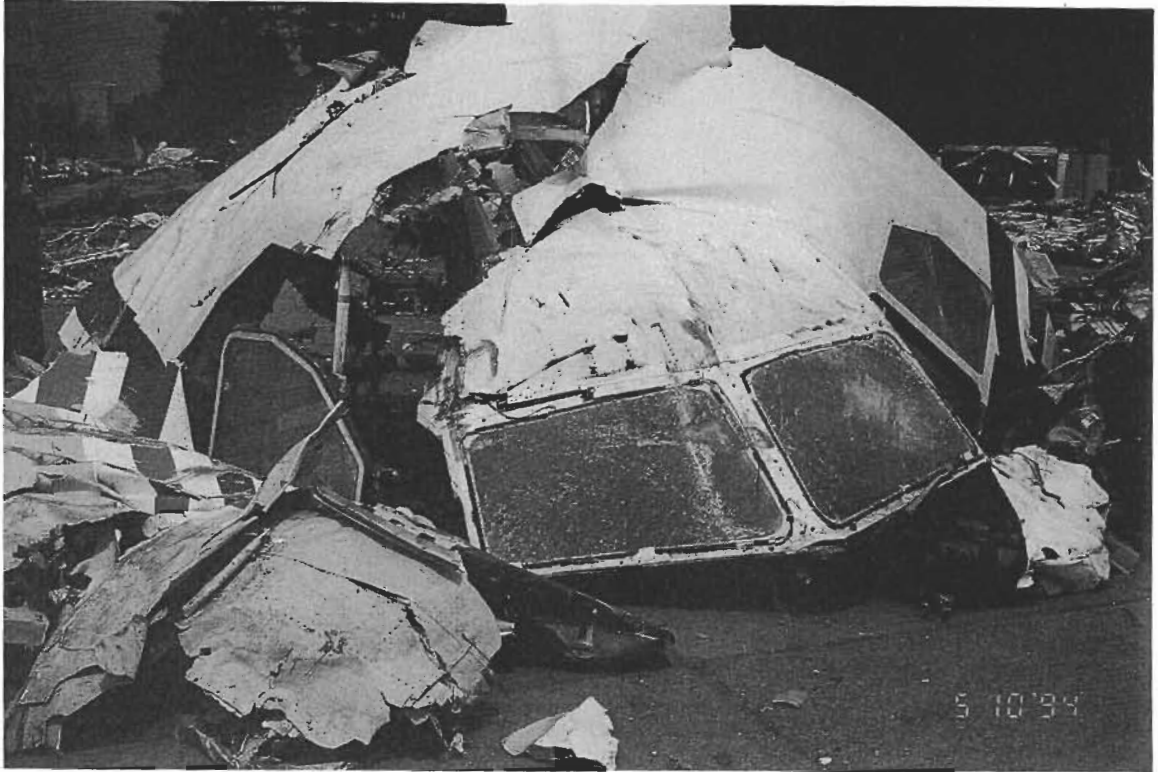

Photo.28 Part of Outside Surface of the R1 Door



Photo.29 Surface of Front Fuselage

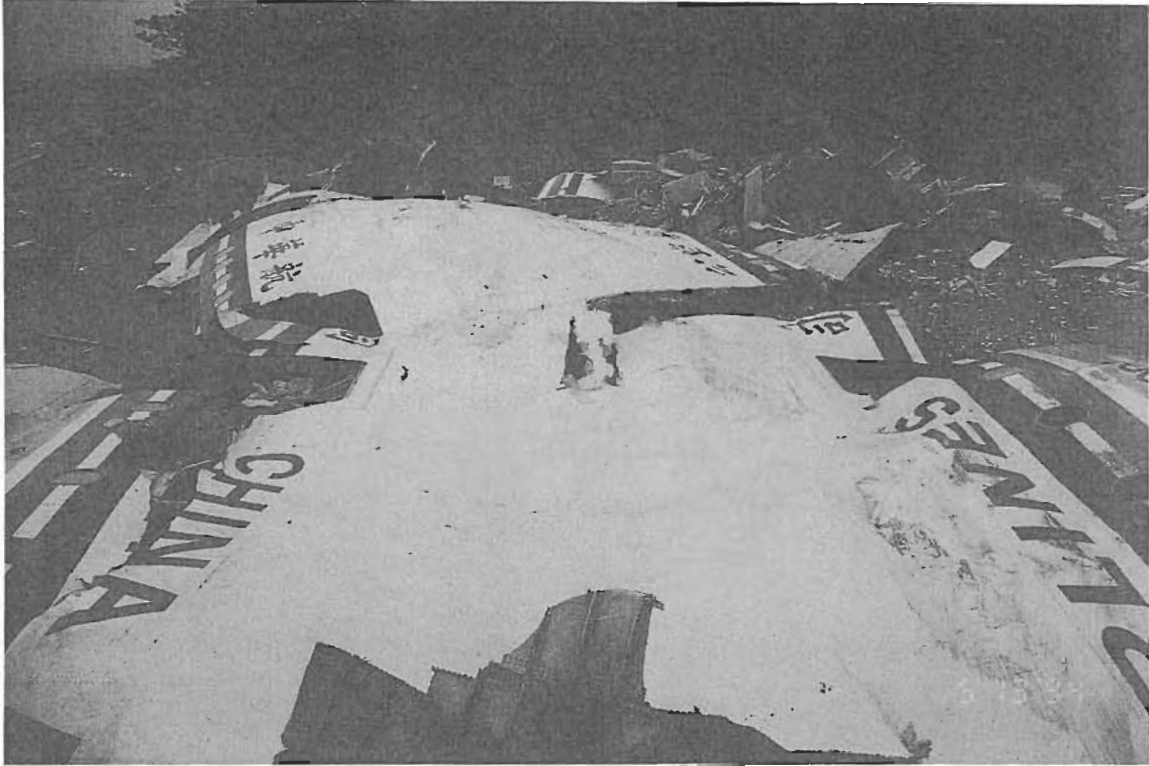

Photo.30 Burnt Fuselage Surface

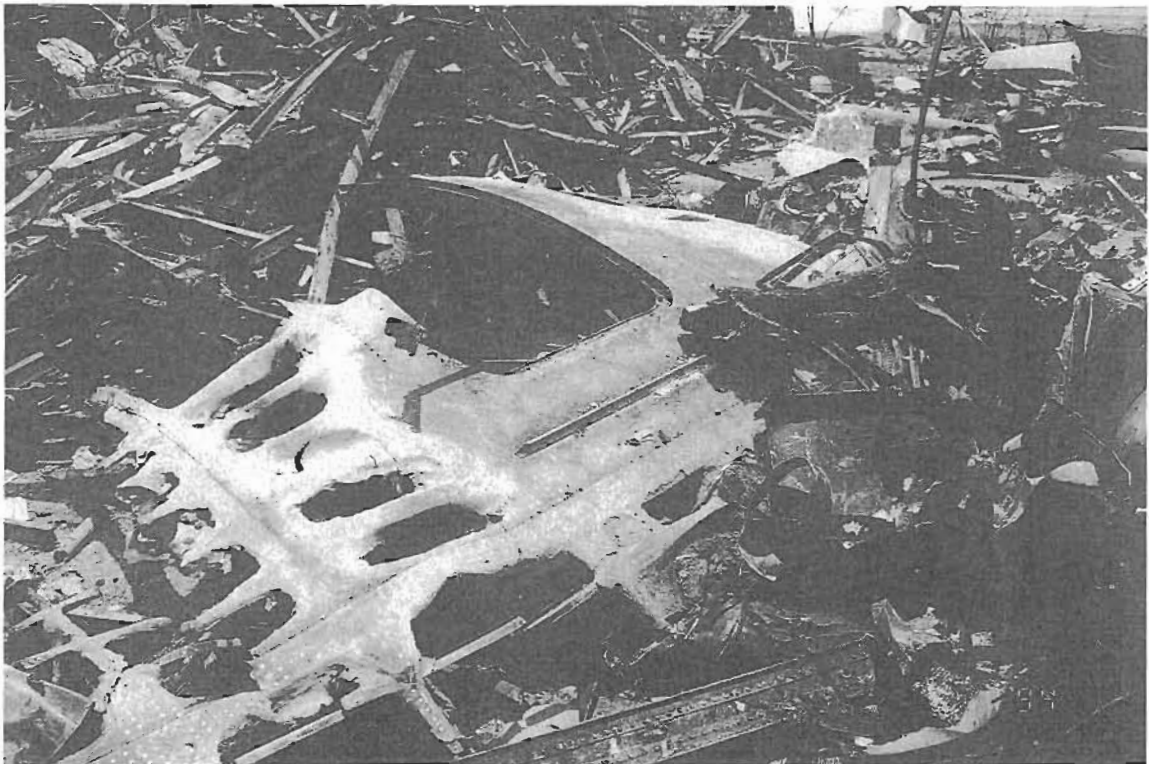

Photo.31 No.1 Engine

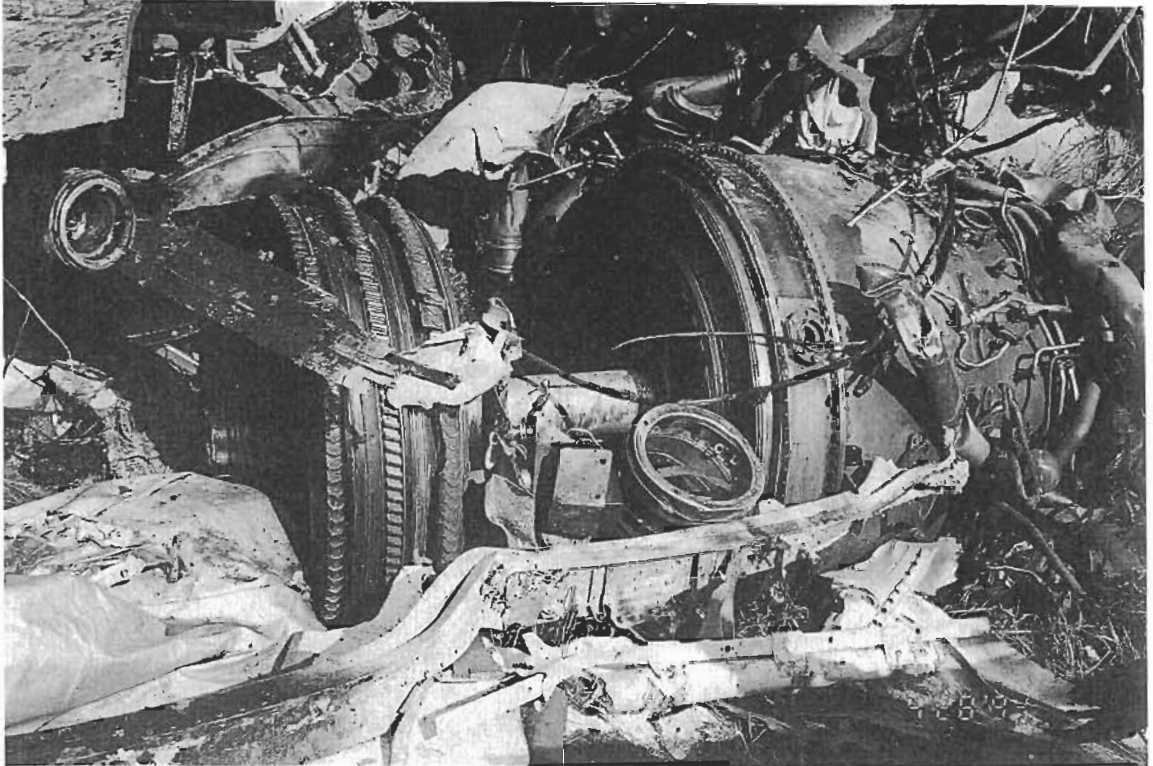

Photo.32 No.1 Engine FADEC

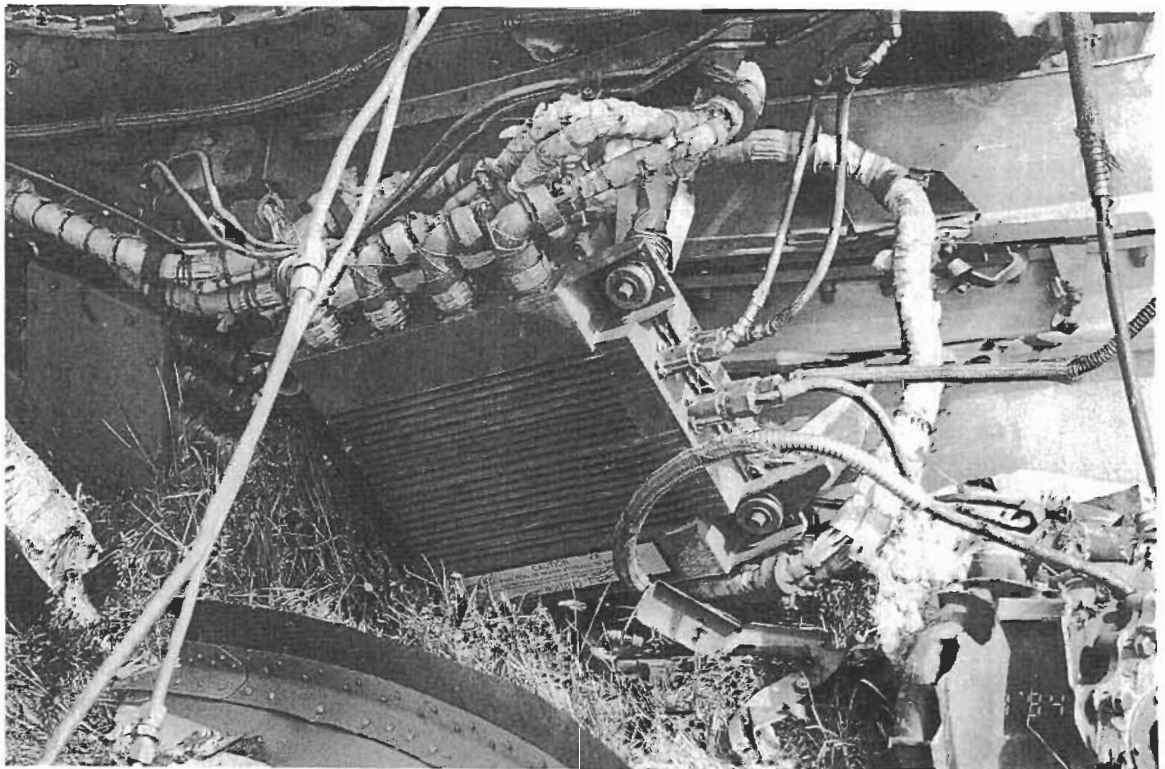

Photo.33 No.2 Engine

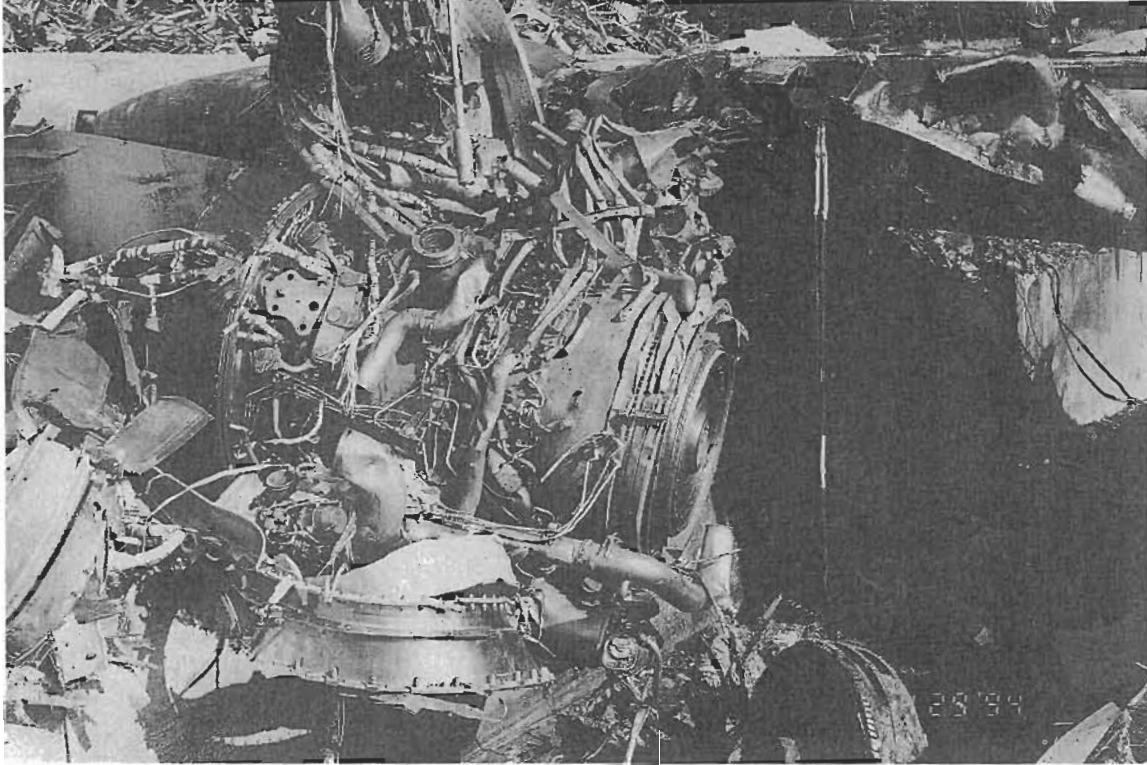

Photo.34 No.2 Engine Pylon



Photo.35 Center Pedestal 1

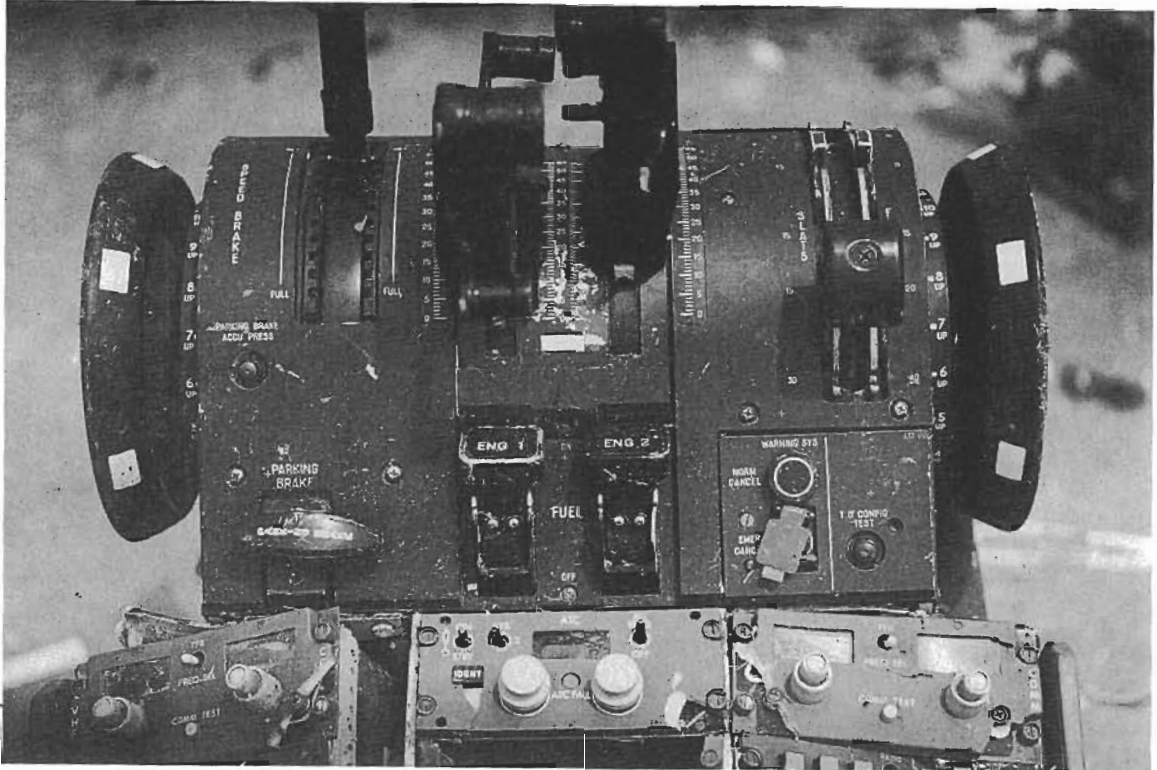

Photo.36 Center Pedestal 2

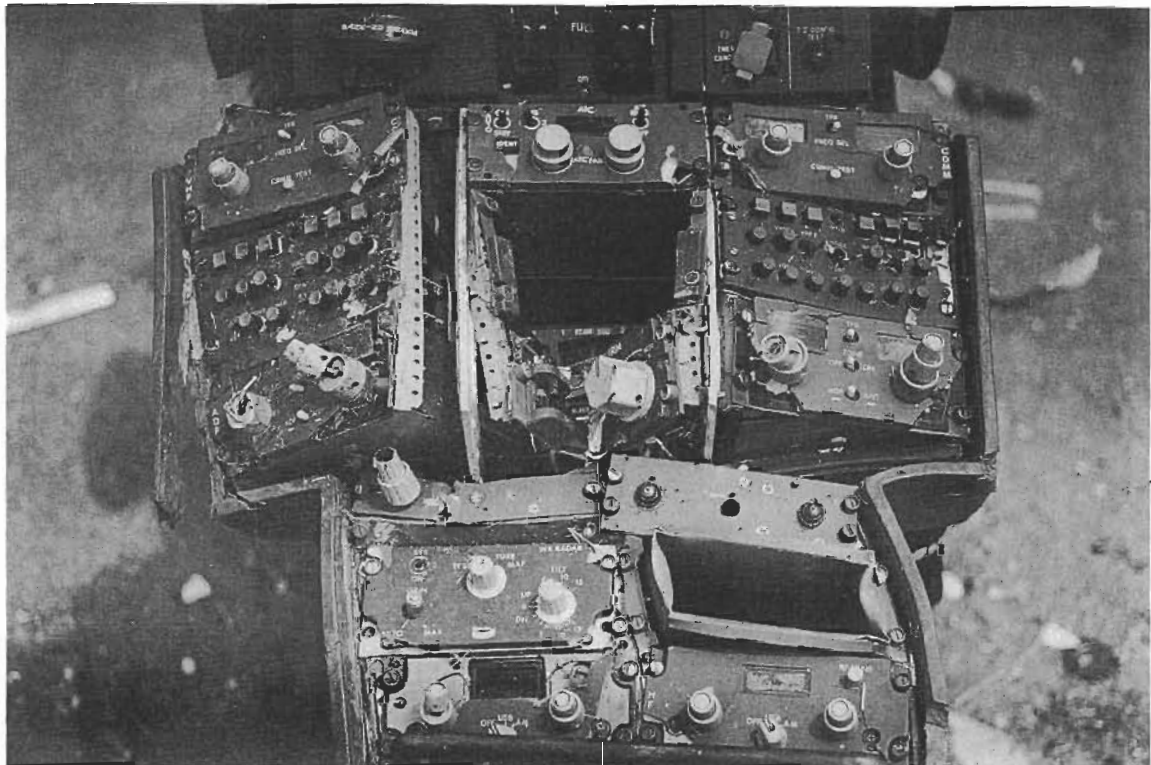

Photo.37 Thrust Lever and GO Lever



Photo.38 SLATS/FLAPS Lever

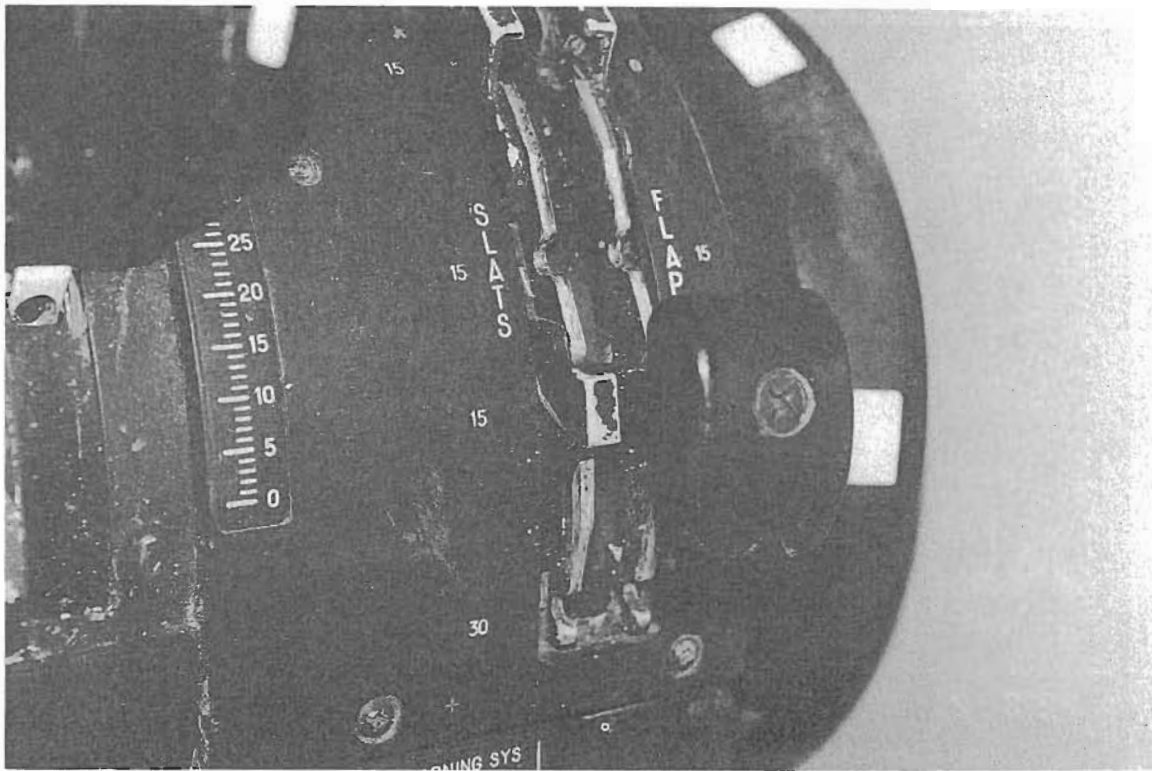

Photo.39 THS Manual Trim Wheel



Photo.40 L/G Lever

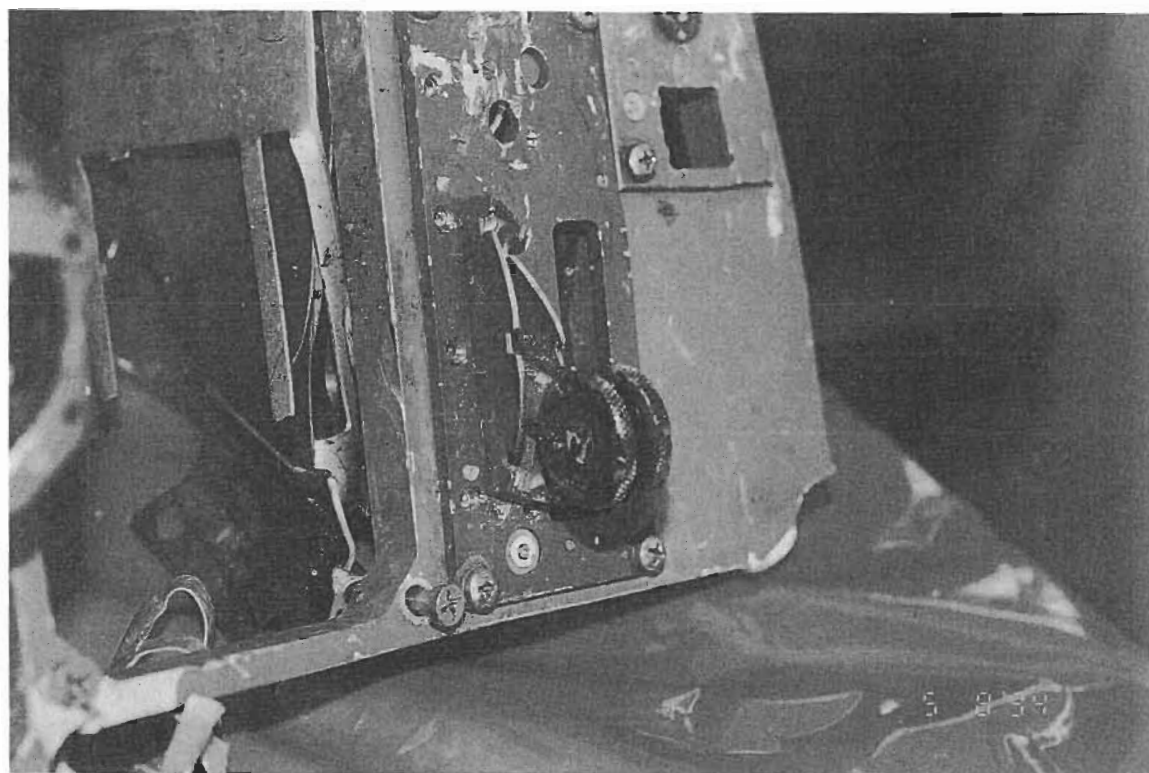

Photo.41 Outward Appearance of Display Unit with Broken Indicators



Photo.42 Captain and Center Light Panel

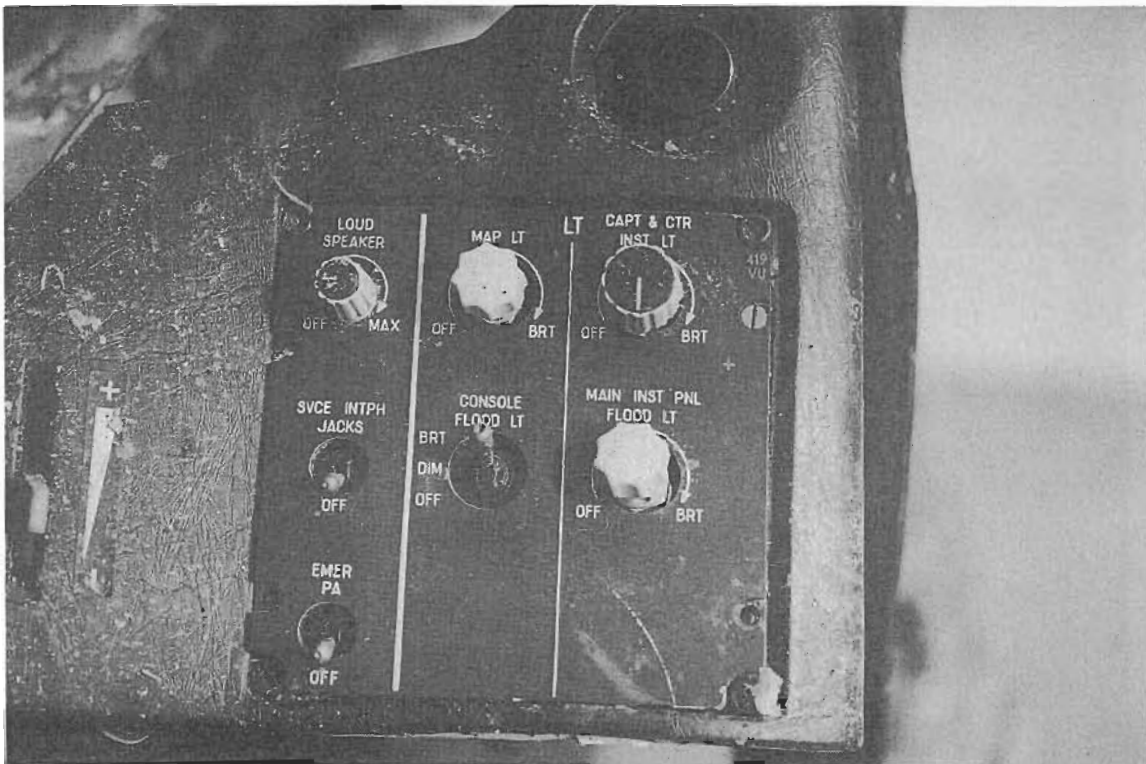

Photo.43 DFDR



Photo.44 CVR



Photo.45 CAP's Seat



Photo.46 F/O's Seat



Photo.47 Passenger Seats (for Business Class)



Photo.48 Passenger Seats (for Economy Class)



Photo.49 Impact Mark of the Left Main Gear on the Ground



Photo.50 Impact Mark of the Right Main Gear on the Ground



Photo.51 GO Lever Alignment with Thrust Lever

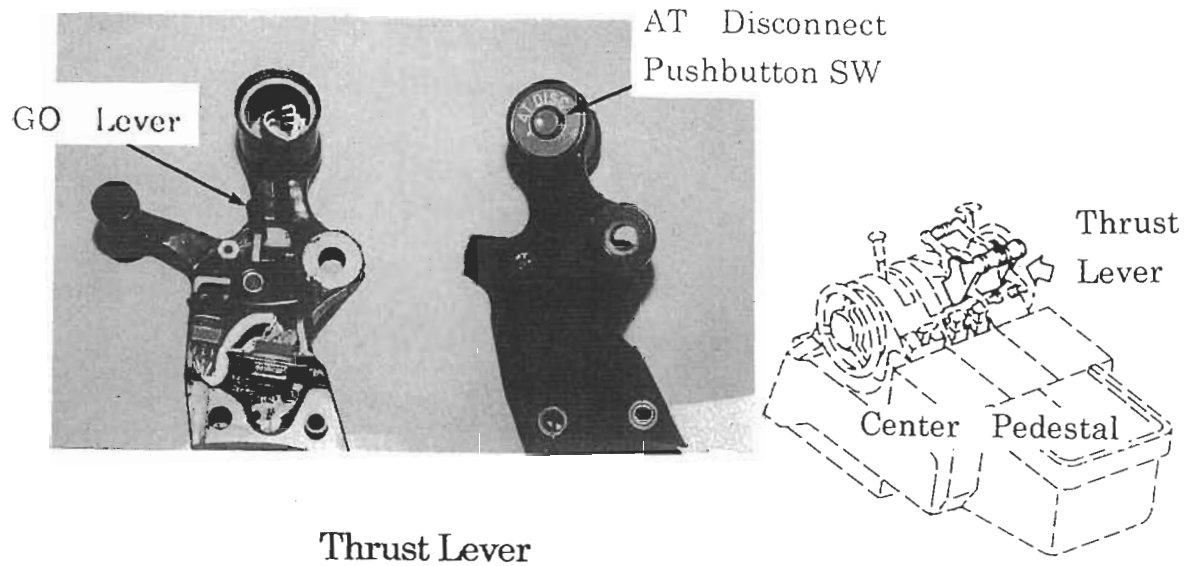

Thrust Lever

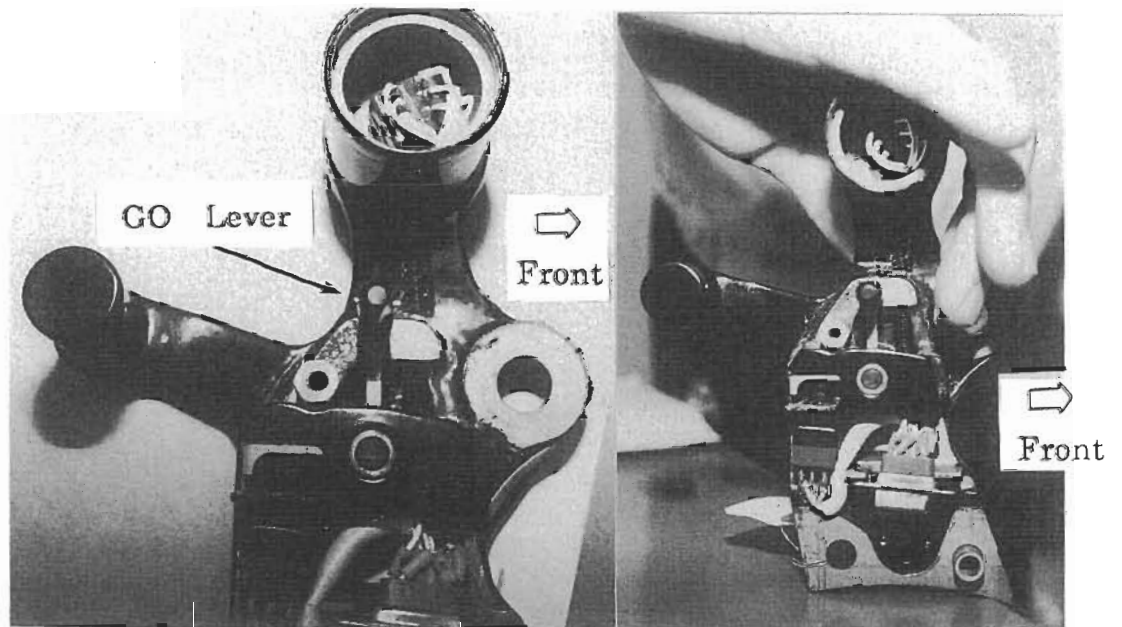

Left Side Thrust Lever

Appendix 1 Outline of automatic flight system

1. Outline of the system

The A300-600 AFS is designed to assist pilots to secure safe flight by realizing the optimum flight situation throughout all the phases from takeoff to landing.

The aircraft is thoroughly controlled by servo system. The command signals are calculated by FAC, FCC and TCC and sent to the system so as to carry out flight. The flight conditions are indicated on FMA and ECAM.

The computer system as each component of FAC, FCC and TCC operates under self-monitor capabilities and has FAIL PASSIVE function which detects the malfunctions of the system and isolates the fault unit before it affects aircraft maneuver.

These computers have dual operation system with FAIL OPERATIVE function which enable to switch a fault current system into standby system having operated in parallel with another power supply.

The functions of AFS are described as follows mainly in approaching and landing phase. And these functions are in accordance with the specification of China Airlines A300-600 at the time of the accident.

2. FAC

FAC has the following functions.

(1) YAW DAMPER function
- DUTCHROLL DUMPING

This function activates when the IRS detects a yaw rate.

- TURN COORDINATION

This function activates when the EFCU detects a roll control wheel deflection above a predetermined threshold.

- ASSISTANCE TO THE AUTOPILOT

This function provides an assistance to the AP in case of engine failure to counter the induced lateral acceleration during dynamic phase of the recovery.

(2) PITCH TRIM function

This function sends a pitch-command to THS and has the following subfunctions.

① ELECTRIC TRIM

The load on the control column is alleviated by this function which balances the pitch axis moving the THS. The neutral position of the elevator is on the chord line of THS. The electric trim is available when in manually controlled flight or an AP is in CWS.

② AUTO TRIM

This function is activated by AP engagement. It has the same function as the electric trim and in addition, prevents the aircraft from bumping when an AP is disengaged. It is active when the AP is engaged in CMD and when the AP is engaged in CWS and pitch trim control switch is not operated.

③ MACH/Vc TRIM

This function improves the longitudinal static aircraft stability by varying the THS position as a function of Mach number or Vc.

MACH TRIM is active in clean configuration (SLATS/FLAPS 0/0) and above MACH 0.7. Maximum authority is 0.7 pitch-up.

Vc TRIM is activated in all configurations but only above 200Kts. Maximum authority is 1.0° pitch-up.

④ ALPHA TRIM

This function restrains pitch-up produced in high Mach numbers, as well as high AOA at low speed. It is active when no AP is engaged and no AIRBREAK is extended. Maximum authority is 1.5° pitch-down. It is also active in low speed in 15/0, 15/15 and 15/20 configuration. Maximum authority is 4.0° pitch-down.

⑤ Override function

All these trim functions can be overridden by MANUAL PITCH TRIM CONTROL WHEEL. Movement of this wheel disconnects both pitch trim systems and pilots can override the THS.

(3) Flight Envelope Protection Function

Alpha Floor Protection Function

This function protects aircraft against stall with a maximum thrust automatically selected by TRP, when an excessive AOA is detected. When the alpha floor function is activated, "THR L" is displayed on FMA and the thrust levers move forward by the speed of 8 deg/sec.

3. ATS(TCC)

(1) General

TCC assures the following functions.

- Continuously computes thrust limit corresponding to the mode selected on TRP.
- Output signals to acquire and maintain the thrust limit or a target thrust.
- Output signals to acquire and maintain the SPD/MACH.
- Retract the THR to the idle position (RETARD MODE).

(2) Connection with engine control

A single electric actuator actuates the THR levers through two coupling units. Each THR lever position is sensed by 3 resolvers which transmits the command signal to the corresponding FADEC and feed back to the TCC. The pilot can control the engine thrust manually overriding the auto thrust for each engine by applying a light load on the throttle lever.

4. AP/FD systems (FCC)

(1) GENERAL

- ① The different modes are selected through push button located on the FCU.
- ② The FD provides information to the pilot to allow manual guidance of the A/C.
- ③ When an AP is engaged in CWS, the AP maintains the pitch attitude and the bank angle at the time of engagement. The CWS function allows the pilot to manually change these reference values by applying a load on control column or wheels. (More load is required in a greater Mach number.)
- ④ When one or two AP are engaged in CMD, the aircraft is controlled automatically according to the selected mode.
- ⑤ Each AP can be engaged by setting the corresponding AP levers to ON. It is disconnected intentionally when the lever is set manually to OFF, or when one of the AP disconnect push buttons on the control wheels is pressed.
- ⑥ The two AP (FCC) can not be engaged simultaneously in CMD, except in LAND or GO AROUND mode.
- ⑦ By setting an AP levers to ON when another AP was engaged, the previously engaged AP will be disconnected, when the dual operation is not allowed.

(2) AP/FD Mode is activated by FCU in the following modes. (Examples of each mode are referred to a ~h of figure 2.)

- ① BASIC Mode
This mode maintains V/S and HDG.
With the power ON or another mode disengaged, it stabilizes the attitude around the center of gravity and maintains the current heading. It keeps V/S as the V/S mode. It also keeps the heading at the time when the bank becomes 5 deg or less as HDG mode.
- ② ALT Mode
This mode maintains the level-off altitude, SPD/MACH mode is engaged on ATS. It is not engaged in LAND track phase.
- ③ LVL/CH Mode
This mode is to change an altitude.
This mode is engaged except flap position 40° when the FCU selects a different altitude from the current altitude.
- ④ PROFILE Mode
FMS controls the vertical navigation and the thrust when A/THR push button is armed.
- ⑤ HED/SEL Mode
This mode is to change the current heading.

The inner knob of HDG/SEL allows the current heading to change and the outer knob allows the maximum bank angle to set.

⑥ NAV Mode

The control of horizontal navigation is conducted by FMS.

⑦ VOR Mode

This mode allows an aircraft to capture and maintain VOR course.

This mode has three phases “Arming”, “Capture” and “Track”.

This mode is disengaged with GA, NAV or LAND mode selected.

⑧ LOC Mode

This mode is to capture and maintain the LOC course.

It has three phases, “Arming”, “Capture” and “Track”.

⑨ TAKE OFF Mode

This mode is to carry out the longitudinal and lateral mode operation at time of take off.

This mode is engaged by Go lever operation.

⑩ LAND mode

This mode captures and maintains an ILS beam (LOC beam and GLIDE beam) then guides the aircraft to align the runway axis and to flare.

•Engagement conditions

LAND mode is engaged by pushing the LAND push button:

•Radio altimeter height is greater than 400ft.

•An ILS frequency and a runway course are selected on the ILS control panel.

•Disengagement

LAND mode is disengaged by one of the following operations.

•Selection of GO AROUND mode. (all phases)

•Pressing a second time LAND push button. (except for LAND TRACK phase)

•Selecting other modes. (LOC CAPTURE, LOC TRACK, GS CAPTURE or GS TRACK phase)

⑪ GO AROUND mode

This mode allows to perform a go-around with a longitudinal and lateral guidance of the A/C. The longitudinal mode is SRS which allows to acquire and maintain VTG+10kt. The lateral mode maintains the wings at level. In addition, it engages THR mode in ATS.

•Engagement

GO AROUND mode is engaged by triggering GO LEVERS provided SLATS/FLAPS is extended to at least 15°.

•Disengagement

GO AROUND mode is disengaged by selecting other modes except for LAND mode. If a longitudinal mode is selected, HDG mode engages as lateral mode. If a lateral mode is selected, SRS remains active as longitudinal mode.

5. Overriding by control column

When the AP is engaged in one of the modes of except LAND Track mode or GO AROUND mode, the AP disconnects when the pilot input to the control wheel over 15 kgf.

On the other hand, when in LAND Track mode or GO AROUND mode, if the pilot applies specific force to the control wheel, he can override elevator control by AP.

For these two modes, the AP do not automatically disconnect, regardless of the force the pilot applies to the control wheel. For example, when AP is engaged in GO AROUND mode if the pilot override the autopilot by applying nose down motion to the elevator, THS moves to nose up direction in order to comply with the objectives of the current GO AROUND mode.

According to FCOM , this override function was installed in order to protect the pilot against AP abnormal behavior. As described in the above, when the pilot move the control wheel and if this control input is against the elevator order of the AP, the AP will move the THS so as to maintain the aircraft on the scheduled flight path, a risk of out of trim is real and may lead to a hazardous situation in LAND and GO AROUND mode only, which is given as a caution in FCOM. (See Appendix 2-2 and 2-4)

6. Warning system

(1) Stall Warning

Stall warning activates when speed drops to about 1.12 V_s . AOA at the time is about 8.5° in clean configuration, and about 15° on other occasions. The stick shaker operates and warning (cricket) sounds.

(2) GPWS

GPWS provides pilot with aural warning and warning lights, when the current flight path flown is in proximity to terrain or when the aircraft is making approach to land without appropriate landing configurations.

(3) Landing capability change

Should there be a malfunction of instruments used for approach, the category of landing is lowered. When GA mode is engaged during an ILS approach in manual operation, the landing capability is lost. And at five seconds after the occasion has been detected, a warning sounds to indicate a decrease of landing capability. (See Figure of Appendix 1)

7. An example of operation and annunciation of LAND mode

- (1) One AP in CMD with PROFILE and NAV mode is engaged. On the ILS control panel, ILS frequency and runway course is selected.
- (2) When LAND push button is pressed, LAND mode arms and CAT2 illuminates on FMAs. CAT 3 illuminates when the both APs are engaged in CMD.
- (3) LOC CAPTURE engages near the interception point and LOC★ illuminates on FMAs.
- (4) LOC TRACK engages after the aircraft is stabilized on the LOCALIZER, and LOC illuminates on FMAs.
- (5) GS CAPTURE engages when GS deviation is smaller than 2/3 dots and G/S★ illuminates on FMAs. And ATS is engaged in SPD mode by A/THR function, and SPD illuminates on FMAs.

- (6) GS TRACK engages when the aircraft has been stabilized on the GLIDE SLOPE for at least 10sec, and G/S illuminates on FMAs.
- (7) LAND TRACK engages at 400ft radio height, provided LOC TRACK and GS TRACK has been activated for more than 10sec. LAND illuminates on FMAs.
- (8) FLARE phase initiates at about 50ft radio height, and FLARE illuminates on FMAs.
- (9) At about 30ft radio height, RETARD of THR is initiated in ATS, and RTAR illuminates on FMAs. (See Fig 2 of Appendix 1)

Attached Figure 1 FCU and FMA

1 AP / FD

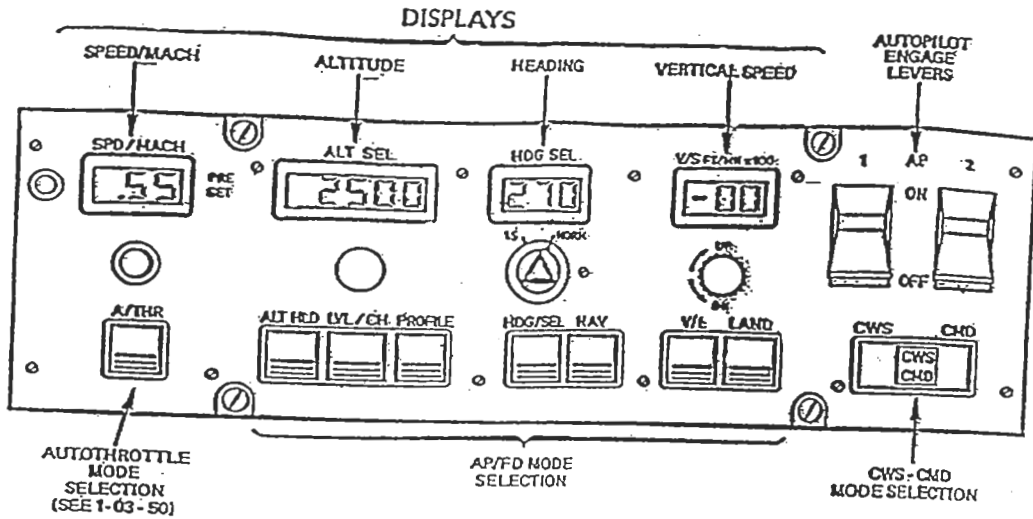

2 FMA

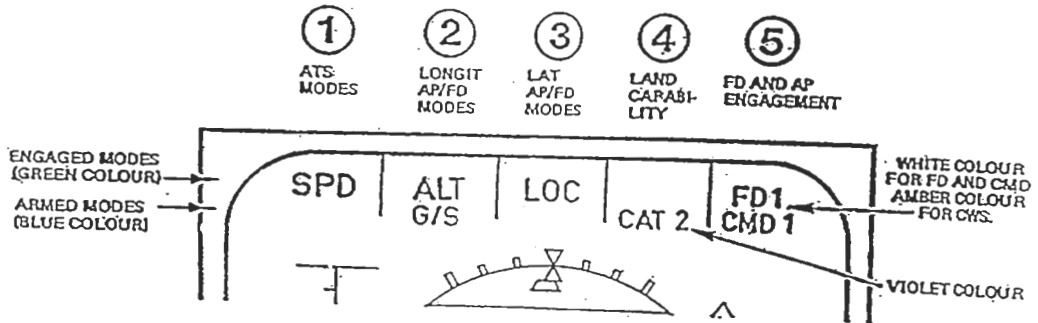

PFD SCREEN DATA DISPLAY POSITION

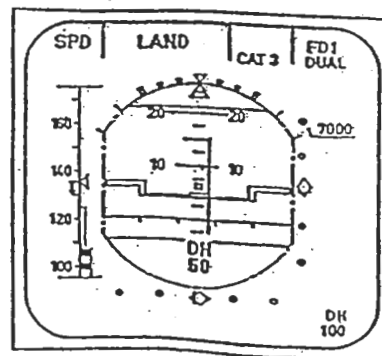
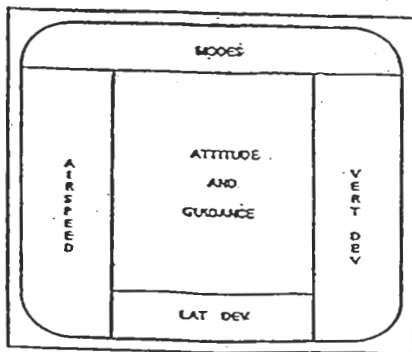

Attached Figure 2 Example of Indication

① BASIC MODE

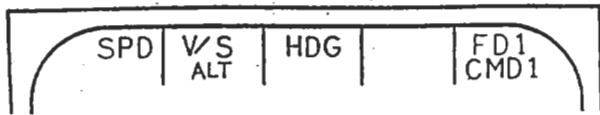

② ALT MODE

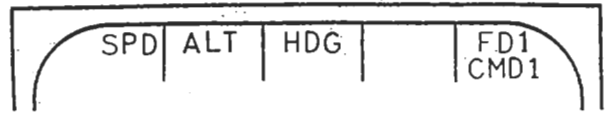

③ LVL/CH MODE

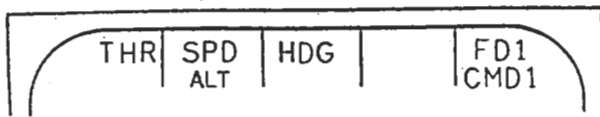

④ PROFILE MODE

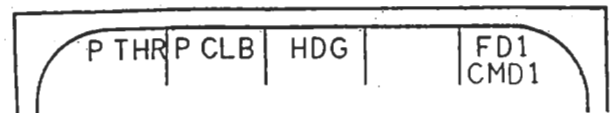

⑤ HDG/SEL MODE

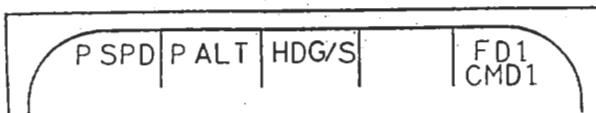

⑥ NAV MODE

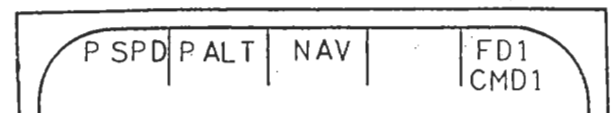

⑦ VOR MODE

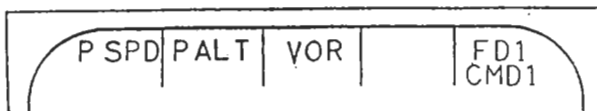

⑧ LOC MODE

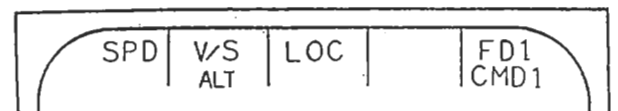

⑨ TAKE OFF MODE

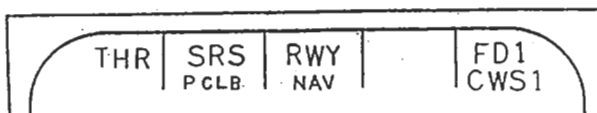

⑩-1. LAND MODE (ARM)

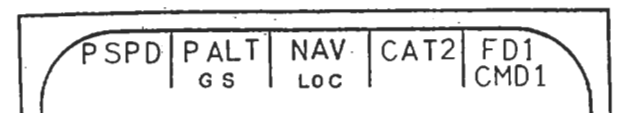

⑩-2. LAND MODE

(LAND Track phase, R. ALT below 400ft)

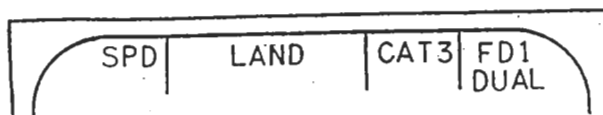

⑪ GO AROUND MODE

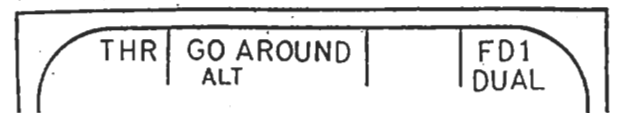

Attached Figure 3 Operations and Displays on Instrument Panels at the Time of Landing Approach

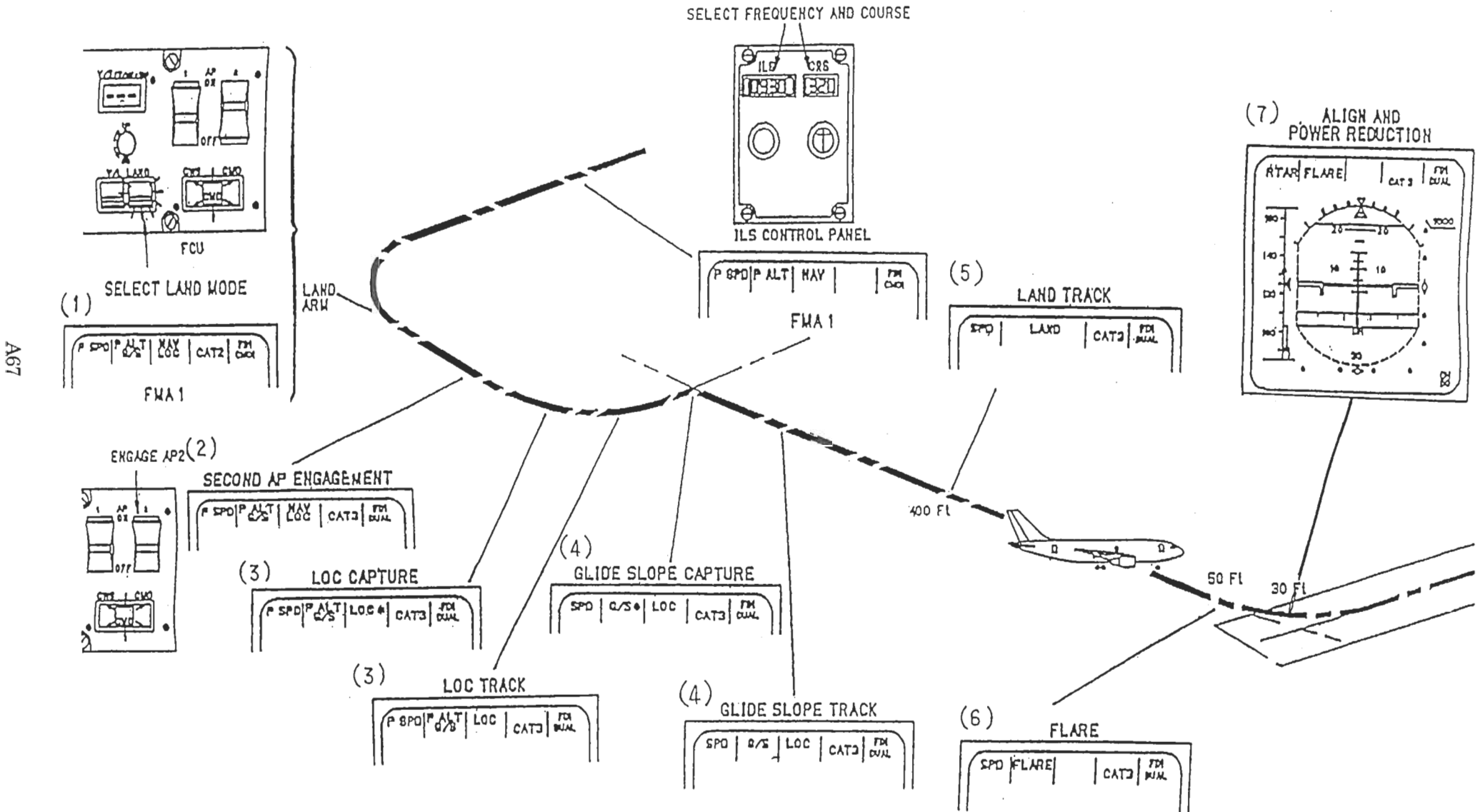

 FLIGHT CREW OPERATING MANUAL	AUTOMATIC FLIGHT SYSTEM		1.03.67	
	AUTOPILOT / FLIGHT DIRECTOR		PAGE 4	
	COMMON MODES		REV 14	SEQ 030

LAND MODE

This mode captures and maintains an ILS BEAM (LOC BEAM and GLIDE BEAM) then guides the A/C during flare and on the runway axis.

- This mode can be used with :
- one or two FD's engaged only.
 - one or two FD's engaged and one AP in CWS.
 - one or two AP's in CMD.

ENGAGEMENT

LAND mode is engaged by pressing LAND pushbutton on FCU provided :

- Radio altimeter height is greater than 400 ft.
- An ILS frequency and a RWY CRS have been selected on the ILS control panel.
- GO-AROUND mode is not engaged.
- The following equipments (in addition of FD or AP engagement conditions) are operational :

CAPABILITY →	CAT 1	CAT 2	CAT 3
EQUIPMENTS ↓			
AP/FD	1FD or 1AP in CMD	1AP IN CMD	2AP IN CMD + 1FD
AUTOTHROTTLE	-	-	ENGAGED IN SPEED MODE
ILS receiver	N° 1 if FD1 N° 2 if FD2	N° 1 and N° 2	N° 1 and N° 2
PFD (Primary flight display)	N° 1 if FD 1 N° 2 if FD 2	N° 1 and N° 2	N° 1 and N° 2
IRS (Inertial reference system)	N° 1 and (N° 2 or 3) if FD 1 N° 2 and (N° 1 or 3) if FD 2	N° 1 and (N° 2 or 3) if AP 1 N° 2 and (N° 1 or 3) if AP 2	N° 1 and N° 2 and N° 3
RADIO ALTIMETER	N° 1 if FD 1 N° 2 if FD2	N° 1 if AP 1 N° 2 if AP 2	N° 1 and N° 2
HYDRAULICS SYSTEMS	-	G and (B or Y) if AP 1 Y if AP 2	G and B and Y
ELECTRICAL POWER	GEN 1 or GEN 2 or APU GEN	GEN 1 or GEN 2 or APU GEN	two among GEN 1 or GEN 2 and APU GEN
YAW DAMPER	-	N° 1 or N° 2	N° 1 and N° 2
PITCH TRIM	-	N° 1 or N° 2	N° 1 and N° 2
Failure Warning Computer	-	N° 1 if AP 1 N° 2 if AP 2	N° 1 and N° 2

Notes : 1. When LAND mode engages in ALIGN or ROLL OUT phase an automatic reversion to FD BARS display on PFD's is done if FPV symbols were previously displayed.

2. Independently of LAND mode engagement but provided VOR/NAV/ILS switch is on ILS position, deviation from LOC and GLIDE BEAMS are given on outside ND and PFD.

3. If, when LAND mode is engaged, a VOR/NAV/ILS switch is on VOR or NAV, an « ILS » light flashes on the outside PFD.

4. Roll out mode availability is part of LAND mode engagement conditions. This means that any roll out failure prevents LAND to be armed on the side where AP/FD is affected.

OPERATION - ANNUNCIATION

- Before engagement, A/C configuration is, for example :
 - one AP in CMD with PROFILE and NAV mode engaged.
 - ILS frequency and RUNWAY COURSE selected on ILS CONTROL PANEL (1)

- When LAND p.b. is pressed (2)
 - LAND mode arms (blue GS and LOC on both FMA's and LAND p.b. illumination)
 - Violet CAT 2 (or CAT1 if some capability conditions are not met) illuminates on both FMA's.
 - From this moment a second AP can be engaged in CMD (3).

Note : 1. When LAND Mode is engaged radio altimeter test (on LATERAL panel) is no longer possible.

2. If two AP are in CMD, LAND selection causes the electrical power supply SPLITTING. DC NORM BUS and DC ESS BUS (coupled in cruise) are split to ensure the FAIL OPERATIONAL feature of the AFS.

- For LOC CAPTURE and LOC TRACK phases see LOC mode in 03-66.

- GS CAPTURE phase (green GS* on both FMA's) engages when GS deviation on PFD is smaller than 2/3 dot and provided LOC CAPTURE phase has been initiated.

Note : 1. This phase causes automatic engagement of SPD mode in ATS, if A/THR function is active.

2. SUPERVISORY OVERRIDE is possible during CAPTURE when an AP is in CMD.

- GS TRACK phase (green GS on both FMA's) engages when the A/C has been stabilized on the GLIDE SLOPE for at least 10 s.

Mod. : 5686

Appendix 2 An Extract from A300-600 FCOM

 A300-600 FLIGHT CREW OPERATING MANUAL	STANDARD OPERATING PROCEDURES		2.03.01	
	GENERAL INFORMATION			
	PAGE 1		REV 18 SEQ 001	

FOREWORD

Procedures contained in this chapter are recommended by AIRBUS INDUSTRIE.

They are consistent with the other chapters of this Manual. Standard operating procedures are not certificated by the authorities and in the judgment of the Manufacturer, are presented herein as the best way to proceed from a technical and operational standpoint. They are continuously updated taking into account inputs from all operators and lessons of the manufacturer's own experience. In the same manner they may be amended as needed by the operator.

However, if the FCOM is used as the onboard operational manual, the manufacturer recommends channelling any suggested amendment through him for early publication so as to maintain the consistency of the manual.

The operator should be aware that a complete rewrite of this chapter may be done under his own responsibility but could lead to difficulties in updating and maintaining the necessary consistency with the other chapters of this manual.

PRELIMINARY

Following sections provide expanded information related to normal procedures.

Standard operating procedures consist of inspections, preparations and normal procedures.

All items are listed in a sequence following a standardized scan of the cockpit panels, except when required by the logic of actions priority, to ensure that all actions are performed the most efficient way.

Standard operating procedures are divided into flight phases and are accomplished by recall.

These procedures assume that all systems are operating normally and that all automatic functions are used normally. Some normal procedures, which are non routine will be found in chapters 2.02 PROCEDURES AND TECHNIQUES and 2.18 SPECIAL OPERATIONS.

NORMAL CHECK LIST

After completion of a given procedure the related normal check list is used to ascertain that the safety points have been checked.

The crew member reading the check list should announce the completion of the check list (eg. « LANDING C / L - COMPLETED »).

The normal check list developed by AIRBUS INDUSTRIE takes advantage of the ECAM system and includes only the items that may have a direct impact on safety and efficiency if not correctly accomplished.

All normal check lists are initiated by the PF and read by the PNF.

The normal check lists are of « THE CHALLENGE / RESPONSE » type. The appropriate crew member shall respond to the challenge, only after having checked the existing configuration. If the configuration is not in accordance with check list response he will take the corrective action before answering.

If a corrective action is not possible, he will modify the response so as to reflect the actual situation (specific answer). The other crew member will cross check whenever

necessary the validity of the response. The challenger will wait for the response before proceeding any further.

For those check list items identified « AS RQRD » the actual condition or configuration of the system will be stated as the check list response eg. ANTI ICE ON.

Note : Normal C / L are not DO LIST.

The actions or checks should be performed prior to the C / L reading.

Obviously, corrective action should be undertaken if the proper condition is not achieved at the time of reading.

COMMUNICATION

Cross cockpit communication for any two pilot crew is VITAL. Any time a crew member makes any adjustments, changes, etc. to any information or equipment on the flight deck, he will advise the other crew member of his intentions and get an acknowledgement. This includes but is not limited to such items as FMS alterations, changes in speed / mach, tuning navigation aids, flight plan deviations, and selecting such systems as anti-ice and pack low flow.

Use headsets from engine start up to top of climb and from top of decent up to parking.

USE OF AUTOPILOT and AUTO THRUST

Philosophy :

The design philosophy of the A300-600 includes the use of the latest technology to reduce pilot operational workload, thus subtly changing the bias of his task from that of operator to that of monitor.

Inherent in this philosophy is the use of the autopilot from just after take off to, if necessary, the end of the landing rollout.

Operation :

The use of the autopilot in this way frees the PF from routine handling tasks and allows him the time to monitor and assess the operational situation.

In practice this means that hand flying should be minimized, particularly in the case of departures or arrivals from busy airports. As a matter of routine the autopilot should be engaged as soon as possible after take off and, circumstances permitting, remain engaged to a late stage on the approach.

Remember, the autopilot can fly the aircraft accurately throughout the normal flight phases and ensures passenger comfort. In addition, the autopilot copes efficiently and effectively with engine failure and windshear situations.

Hand flying of the aircraft should be practiced at those airfields where the traffic density is light and the overall workload is low. The ATHR should be kept active from THR RED ALT down to retard in the flare unless heavy turbulence conditions are encountered.

With the A/P engaged the PF will make any required short term changes on the FCU or CDU. If significant changes to the F-PLN are required these may be made by the PNF. When hand flying the A/C the PF will request the PNF to carry out such actions.

The result of any selection on the FCU must be checked on the PFD. The effect on the flight path must be monitored on basic flight instruments (heading, speed, altitude, V/S, FPA...).

R
R
R
R

 A300-600 FLIGHT CREW OPERATING MANUAL	AUTOMATIC FLIGHT SYSTEM		1.03.64
	AUTOPILOT / FLIGHT DIRECTOR		PAGE 3 / 4
	AP IN CMD DESCRIPTION		REV 18 SEQ 100

DISENGAGEMENT

AP can be disconnected :

- intentionally
 - by setting the AP lever to OFF (which disconnects the respective AP)
 - by action on either AP disconnect pushbutton located on the control wheels (which disconnects both AP's if they were engaged).
 - when a force above threshold (15 daN) is applied on the stick in pitch except in land and go-around modes.
- automatically
if one of the engagement conditions is no longer met (which disengages the respective AP).

Intentional disconnection or automatic disconnection (when the lost engagement condition does not concern the FD) does not cause mode disengagement. Modes remain available with the FD.

Disconnection of the engaged AP (or of the two, if engaged) causes the red MASTER WARNING to be lit in front of each pilot and the flashing of a red AP OFF warning message on the left ECAM CRT. At the same time an aural warning (CAVALRY CHARGE) sounds.

In addition below 200 ft radio altitude, at the time of disengagement, a red AUTOLAND light flashes on the glareshield, in front of each pilot, if LAND mode is engaged in LAND TRACK phase.

AP OFF, CAVALRY CHARGE and AUTOLAND warnings will be cancelled by pressing either AP disconnect p.b.

AUTOMATIC COMPENSATION IN CASE OF ENGINE FAILURE

An automatic compensation (on YAW axis) is made by the AP when an engine fails if the following conditions are met :

- An AP is engaged in CMD
- SLATS are extended to at least 15°
- The AP is not in ROLL OUT or ALIGN phase.

In the other cases, use RUDDER TRIM to obtain stabilized straight and level flight.

Note : YAW DAMPER provides an additional compensation (on YAW axis) if an AP is engaged in CMD with SRS or GO AROUND modes.

SUPERVISORY OVERRIDE FUNCTION

This function is available with AP in CMD in the following cases :

lateral : in VOR mode and in capture phase of LOC and LAND modes

longitudinal : in GLIDE SLOPE capture phase of LAND mode.

During these phases, the pilot, by applying a load (above a threshold) on the control wheel, operates a control surface deflection proportional to the load applied. When the pilot releases his load, the AP guides again the A/C along the flight path corresponding to the mode engaged.

Outside these phases, supervisory override is not available.

AUTOPILOT OVERRIDE

Torque limiter installed between each AP actuator and the corresponding flight control channel allows the pilot to override the AP by disconnecting the actuator from the flight control.

However AP remains engaged and when override effort is released the AP comes back in control.

Loads to be applied are as following.

Pitch 20 kg nose down } ONLY in LAND and GO AROUND
46 kg nose up } modes.

Roll 15 kg

Yaw 65 kg

This override was conceived in order to protect the pilot against AP abnormal behaviour.

CAUTION

On the longitudinal axis, the autopilot override does not cancel the AP autotrim orders. So with AP in CMD, if the pilot counteracts the AP (elevators order) the AP will move the THS (autotrim order) so as to maintain the A/C on the scheduled flight path. A risk of out of trim is real and may lead to a hazardous situation in land and go-around mode only.

 A300-600 FLIGHT CREW OPERATING MANUAL	AUTOMATIC FLIGHT SYSTEM		1.03.64
	AUTOPILOT / FLIGHT DIRECTOR		PAGE 3 / 4
	AP IN CMD DESCRIPTION		APR 95

DISENGAGEMENT

AP can be disconnected :

- intentionally
 - by setting the AP lever to OFF (which disconnects the respective AP)
 - by action on either AP disconnect pushbutton located on the control wheels (which disconnects both AP's if they were engaged).
 - when a force above threshold (15 daN) is applied on the stick in pitch except, below 400 ft when either, LAND or GO AROUND mode is annunciated on FMA.
- automatically
if one of the engagement conditions is no longer met (which disengages the respective AP).

Intentional disconnection or automatic disconnection (when the lost engagement condition does not concern the FD) does not cause mode disengagement. Modes remain available with the FD.

Disconnection of the engaged AP (or of the two, if engaged) causes the red MASTER WARNING to be lit in front of each pilot and the flashing of a red AP OFF warning message on the left ECAM CRT. At the same time an aural warning (CAVALRY CHARGE) sounds.

In addition below 200 ft radio altitude, at the time of disengagement, a red AUTOLAND light flashes on the glare shield, in front of each pilot, if LAND mode is engaged in LAND TRACK phase.

AP OFF, CAVALRY CHARGE and AUTOLAND warnings will be cancelled by pressing either AP disconnect p.b.

AUTOMATIC COMPENSATION IN CASE OF ENGINE FAILURE

An automatic compensation (on YAW axis) is made by the AP when an engine fails if the following conditions are met :

- An AP is engaged in CMD
- SLATS are extended to at least 15°
- The AP is not in ROLL OUT or ALIGN phase.

In the other cases, use RUDDER TRIM to obtain stabilized straight and level flight.

Note : YAW DAMPER provides an additional compensation (on YAW axis) if an AP is engaged in CMD with SRS or GO AROUND modes.

SUPERVISORY OVERRIDE FUNCTION

This function is intended to permit pilots to apply small manual control inputs to assist the autopilot in capturing the glide slope and localizer. R
R
R

This function is available with AP in CMD in the following cases :

lateral : in VOR mode and (in LOC capture and track phases of LOC and LAND modes (LOC* or LOC on FMA)) R
R
R

longitudinal : in GLIDE SLOPE capture phase (GS* on FMA) of LAND mode. R

During these phases, the pilot, by applying a load (above a threshold) on the control wheel, operates a control surface deflection proportional to the load applied. When the pilot releases his load, the AP guides again the A/C along the flight path corresponding to the mode engaged.

Outside these phases, supervisory override is not available.

CAUTION

To prevent guidance disturbance do not apply a force on the control column during LOC phase. R
R

AUTOPILOT OVERRIDE

Torque limiter installed between each AP actuator and the corresponding flight control channel allows the pilot to override the AP by disconnecting the actuator from the flight control.

However AP remains engaged and when override effort is released the AP comes back in control. Loads to be applied are as following.

Pitch 20 kg nose down } only below 400 ft, when either
46 kg nose up } LAND or GO AROUND mode is
annunciated on FMA. R
R
R

Roll 15 kg
Yaw 65 kg

This override was conceived in order to protect the pilot against AP abnormal behaviour.

CAUTION

On the longitudinal axis, the autopilot override does not cancel the AP autotrim orders. So with AP in CMD, if the pilot counteracts the AP (elevators order) the AP will move the THS (autotrim order) so as to maintain the A/C on the scheduled flight path. A risk of out of trim is real and may lead to a hazardous situation in land and go-around mode only.

 A300-600 FLIGHT CREW OPERATING MANUAL	AUTOMATIC FLIGHT SYSTEM		1.03.67
	AUTOPILOT / FLIGHT DIRECTOR		PAGE 8
	COMMON MODES		REV 17 SEQ 200

GO-AROUND MODE

This mode allows to perform a go-around with a longitudinal and lateral guidance of the A/C. In addition it automatically engages THR mode in ATS.

GO-AROUND mode can be used with :

- one or two FD's engaged only.
- one or two FD's engaged and one AP in CWS.
- one or two AP's engaged in CMD.

The LONGITUDINAL MODE included in GO-AROUND mode is SRS (SPEED REFERENCE SYSTEM) which allows to acquire and maintain :

- the SPEED which is selected on FCU (VAPP) increased by 10 KT with two engines operating.
- VAPP (or the A/C existing speed if it is greater than VAPP) in case of engine failure.

Note : • **PITCH ATTITUDE is limited to 18°.**

- *In case a too high speed is selected on FCU, a 100 ft/min vertical speed is maintained at minimum.*
- *In case a too low speed is selected, V_{LS} (see definition in 03-40) will be maintained at minimum.*

When strong windshear conditions are encountered, an SRS survival strategy is adopted :

- selected speed increased by 10 kts is maintained with two engines operating (the highest of selected speed and A/C airspeed in case of engine failure) until vertical speed decreases down to zero,
- a slightly positive vertical speed is then commanded until airspeed decreases down to slightly above V_{SS} ,
- then airspeed is controlled slightly above V_{SS} , the altitude being reduced while the windshear intensity remains high.

The LATERAL MODE included in GO-AROUND consists of levelling the wings, then of maintaining the wings horizontal.

The commands to be executed are indicated on the PFD by the PITCH BAR (in longitudinal) and the ROLL BAR (in lateral).

ENGAGEMENT

- GO-AROUND mode (and also A/THR function and THR mode in ATS) is engaged by action on either GO-LEVER provided :

R

- SLATS/FLAPS handle is extended to at least 15°.

- Consequences of this action are different depending on the flight phase :

- In flight (main landing gear strut released) and at touch down AP(s) (if engaged) and FD's engage in GO-AROUND.
AP(s) remain(s) engaged in CMD if A/C touches down after GO-AROUND engagement.
- On ground (main landing gear strut compressed) from 0,5 sec to 30 sec after touch down, pressing GO LEVERS has no effect on AP if it is in CMD.
- If no AP is engaged from touch down up to 30 sec after touch down, FD's engage in GO AROUND mode when GO levers pressed.

- If the A/C has touched down for more than 30 sec., AP(s) disconnect(s) but FD's engage in TAKE OFF mode (SRS + RWY or SRS + HDG) if slats are extended to at least 15°.

Note : 1. GA is automatically selected on TRP when SLATS are extended to at least 15°.

2. When GO-AROUND mode is engaged, an automatic reversion to FD BARS display is done on PFD's, if FPV symbols were previously displayed.

DISENGAGEMENT

Disengagement of GO-AROUND mode is possible only by engaging an other mode. If the two AP's were engaged, AP 2 (right side) will disengage.

- When a longitudinal mode is engaged (V/S, ALT, LVL/CH, ALT* or PROFILE mode) :
 - GO-AROUND mode disengages.
 - HDG mode engages as lateral mode..
 - The ATS engages in the mode corresponding to the engaged longitudinal mode.

The reference speed becomes the A/C speed at the time of SRS disengagement if this speed is higher than the previously selected speed except if PRESET was selected.

- When a lateral mode is engaged (HDG SEL, VOR CAPTURE or TRACK phase, NAV CAPTURE or TRACK phase) :
 - GO-AROUND mode disengages.

The longitudinal mode of GO-AROUND (SRS) remains active, SRS illuminates green on both FMA's.

THR remains engaged in ATS.

Mod. : 5686 + 6036 + 7187

 A300-600 FLIGHT CREW OPERATING MANUAL	PROCEDURES AND TECHNIQUES		2.02.03	
	AFS / FPV / DFA / WGD		PAGE 1	
	USE OF AFS		REV 15	SEQ 100

1. GENERAL

A. PRELIMINARY NOTE

In this section, the following is described :

- USE OF AFS described without taking into account the possible coupling to the FMS. Coupling of the AFS to the FMS, will be described in USE OF FMS section.
- USE OF FPV.
- USE OF DFA AND WGD if these systems are installed.

B. INTRODUCTION

The A 300 600 is equipped with a high performance digital Automatic Flight System (AFS). The use of this system is highly recommended to the crew because it :

- reduces crew work load
- maintains a high level of safety
- increases the precision in guidance and tracking of the airplane in all weather conditions down to landing.

The AFS can be used from TAKE OFF, through all phases of flight and down to landing, including roll out.

C. AUTOPILOT/FLIGHT DIRECTOR (AP/FD)

The AP/FD shall normally be used throughout the whole flight either with both FD's* engaged (Manual control of the A/C through the FD BARS on PFD's) or with an AP engaged in CMD** (automatic control of the A/C).

- * An AP can also be engaged in CWS (Automatic maintain of the PITCH ATTITUDE and BANK ANGLE).
- ** Two AP's can be engaged in CMD with LAND or GO AROUND mode.

The FMA (Flight Mode Annunciator) is the normal reference for the actual state of the AP/FD. A FMA is integrated in the upper part of each PFD (PRIMARY FLIGHT DISPLAY).

MAIN RULES OF USE

- 1 - NO PUSHBUTTON EXISTS TO ENGAGE OR DISENGAGE THE FD's.
Their engagement is automatic as soon as electrical power is supplied to the computers (FCC's).
- 2 - HOWEVER ONE FD CAN BE DISENGAGED BY SETTING THE CORRESPONDING « FD/FPV » SWITCH TO OFF or FPV, if no AP is engaged in CMD. (The corresponding FD BARS are out of view).

If an AP is in CMD the FD BARS are out of view when the switch is in OFF or FPV position, but the FD remains engaged.

- 3 - If no AP is engaged in CMD, FMA and FD BARS on PFD 1 are associated with FD1, FMA and FD BARS on PFD2 are associated with FD2.

If an AP is engaged in CMD BOTH FMA's ARE ASSOCIATED WITH THIS AP, but the FD BARS ON THE PFD's REMAIN ASSOCIATED WITH THE CORRESPONDING FD.

- 4 - A mode is engaged by pressing the corresponding pushbutton on FCU or by pressing either GO-LEVER (for TAKE OFF or GO AROUND mode only).

- 5 - A mode is disengaged by pressing a second time the corresponding pushbutton or by pressing another pushbutton (of an incompatible mode).

- 6 - Each AP is engaged in CMD (In flight) or in CWS (on ground) by means of an AP lever on FCU. In flight, switching from CMD to CWS or CWS to CMD is made by pressing the CWS/CMD pushbutton.

- 7 - It is possible to switch over from one AP to the other. The first AP disconnects when the second is engaged (except in LAND or GO AROUND mode where both AP's can be engaged in CMD).

During an AP switching there is no change in the engaged modes except in the two following cases where the modes come back to the BASIC modes (V/S and HDG) :

- If, AP1 being active and FD1 feeding both PFD's (F/O FD switch pressed on F/O SWITCHING panel), AP2 is engaged in CMD. Same thing if AP1 is engaged when AP2 is active and FD2 feeds both PFD's.

- If, AP1 being active and FD BARS being out of view on PFD2 (FPV/FD switch in OFF or FPV position) AP2 is engaged. Same thing if AP1 is engaged when AP2 is active and FD BARS are out of view on PFD1.

- 8 - Each AP can be disconnected by setting the corresponding AP lever to OFF. Both AP's are disconnected by pressing either AP instinctive disconnect p.b. on the control wheels. Or when a force above a threshold (15 Dan) is applied on the stick in pitch (except in LAND, GO AROUND mode)

- 9 - In case of failure, overriding the action of the AP, by exceeding a pre-set force on the flight controls, is possible when AP is in CMD or CWS. But working against the AP is definitely not a normal procedure and should be avoided.

CAUTION

Working, on the pitch axis against the AP in CMD may lead to a hazardous situation in LAND and GO AROUND mode.

So if any abnormal flight control behaviour is encountered during these flight phases :

- check AP status (FMA, FCU)
- If AP engaged, disconnect it and take over.

Mod. : 7187

SUBJECT: AP OVERRIDE

1. REASON FOR ISSUE AND SCOPE

- The purpose of this FCOM BULLETIN is to provide flight crews with background information and operational recommendations in the event of an AP override.

Therefore with these modifications installed, any attempt to override the AP (except in GA and LAND modes) results in AP disconnection.

The autopilot override does not cancel the AP autotrim orders.

2. BACKGROUND INFORMATION

- AP override is a safety device required by the airworthiness authorities to allow the flight crews to regain control from the AP in the event of AP anomalies. Torque limiters installed between each AP actuator and the corresponding flight control channel allow mechanical override of the FCC command, throughout the flight envelope, by disconnecting the AP servo-motor from the flight control surfaces.
- AP remains engaged but inactive except for the autotrim function. However, when override effort is released the AP is reactivated.

With AP in CMD if the pilot counteracts the AP (elevator order), the AP will move the THS (autotrim order) so as to maintain the A/C on the sheduled flight path.

Therefore, in Pitch GA mode, the following scenario may occur :

- During the GA procedure if the pilot immediately pushes on the control column in order to override or to limit the pitch up order, (after a few seconds) this situation would lead to a simultaneous inverse movement of the elevators (due to the pilot action), and the stabilizer (due to autotrim orders).

In such a configuration since the stabilizer efficiency is reater than that of the elevator ; the A/C could reach an abnormal pitch up angle leading to an airspeed decay.

The approximate triggering threshold (from flight control neutral position) expressed in loads to be applied to the control column, control wheel, pedals are as follows :

Pitch 20 daN nose down } at low
46 daN nose up } speed

Roll 15 daN
Yaw 65 daN

- On Pitch axis

NOTE 1

Any action on the Pitch trim control wheel disconnects the AP

NOTE 2

Modifications 5953/A310 and 7187/A300-600 :

These modifications allow the AP to be disconnected by applying a force greater than 15 daN at the control column, in all modes EXCEPT in GA and LAND modes.

3. OPERATIONAL RECOMMENDATION

The AP override is a safety device which operates beyond the normal operation of the aircraft.

If any abnormal A/C behaviour is suspected when AP is in CMD disconnect AP immediately.

CAUTION : Do not attempt to modify A/C flight path acting on controls, if AP is not disconnected.

These recommendations are given in the FCOM : 1.03.65 p 3/4
2.02.02 p1.

Appendix 2-6 Airbus Industrie's Technical Information Distributed to Operators,
Dated May 5, 1994

SUBJECT: ALL A300/A310 AND A300-600 OPERATORS
AUTO PILOT OVERRIDE IN LAND AND GA MODES

THE PRELIMINARY INFORMATION CONCERNING THE NAGOYA ACCIDENT
LEAD US TO REMIND YOU THE FOLLOWING :

AN AP OVERRIDE FUNCTION IS INSTALLED ON A300, A310 AND
A300 600 AIRCRAFT.

THIS OVERRIDE FUNCTION HAS BEEN BUILT IN TO MOMENTARILY
OVERCOME AN AUTOPILOT HARD OVER.

THIS FUNCTION ALLOWS THE PILOT TO OVERRIDE THE AP BY
DISCONNECTING THE ACTUATORS FROM THE FLIGHT CONTROLS.

WITH AP ENGAGED IN LAND OR GA MODE IF THE PILOT COUNTERACTS
THE AUTOPILOT BY MEANS OF ELEVATOR, THE AP WILL MOVE THE THS
SO AS TO MAINTAIN THE A/C ON THE SCHEDULED FLIGHT PATH.

THE AUTOPILOT OVERRIDE DOES NOT CANCEL

THE AP AUTOTRIM ORDERS

FOR EXAMPLE, IF DURING THE GA PROCEDURE THE PILOT OVERRIDES
THE AP BY PUSHING ON THE CONTROL COLUMN, IN ORDER TO LIMIT
THE PITCH UP ORDER, THE FOLLOWING OCCURS :

THE ELEVATOR FOLLOWS PILOT ACTION (NOSE DOWN)
THE THS FOLLOWS AP AUTOTRIM ORDERS (NOSE UP)

IF THE AUTO PILOT IS THEN DISENGAGED THE AIRCRAFT IS LEFT IN
AN OUT OF TRIM SITUATION WHICH MIGHT BE HAZARDOUS IF NOT
TRIMMED BACK.

THE BEST WAY TO DISENGAGE GA MODE IS TO DISENGAGE AP THROUGH
AP INSTINCTIVE DISCONNECT PUSH BUTTON OR TO SELECT ANOTHER
MODE.

REMEMBER, WORKING AGAINST THE AP MAY LEAD TO AN OUT OF
TRIM SITUATION.

NEVER ATTEMPT TO CONTINUOUSLY MODIFY A/C FLIGHT PATH
ACTING ON CONTROLS IF AP IS NOT DISCONNECTED.

IF AP STEERING IS NOT AS EXPECTED DISCONNECT IT.

AT THE DISCONNECTION AFTER AN OVERRIDE, EXPECT AN OUT OF
TRIM SITUATION.

Appendix 3 Examples of the previous incidents and Measures taken after the incidents

1. Examples

(1) March 1, 1985, A300-600 type aircraft

The Airbus Industrie Technical Note dated November 29, 1994 (AI/E-fs n° 420, 0365/94) is shown as follow;

The aircraft was in the approach phase and it was descending with the autopilot(AP) engaged in command(CMD). While the aircraft crossed the selected altitude, the ALT Acquire and then the ALT HOLD mode engaged.

Evidently the crew believed the AP was OFF. In order to keep the aircraft descending, the crew applied a nose-down elevator input, overriding the AP.

As a consequently the aircraft descended below the selected altitude which was 4200ft. This led the autotrim function to command a nose-up movement of the THS in an attempt to regain the selected altitude.

This action ended with the THS at its maximum nose-up electrical stop and the elevators at the full nose-down stop. The pitch attitude which resulted from these actions was close to 10° up.

In a probable attempt to reduce the pitch attitude, the crew reduced the thrust. This action led the speed to decrease to 119 kt. At this moment, the power was increased. This action, combined with the out-of-trim situation, led the pitch attitude to increase to 24°.

A change of the AP mode occurred which led the autotrim function to command a nose-down movement of the THS.

As a result, the pitch up attitude decreased and the speed increased.

A few seconds later, the captain took-over. He applied a manual pitch trim input which automatically disengaged the autopilot.

At the time when this incident occurred, the Automatic Flight System (AFS) on this type had not yet been provided with a function to disengage the AP by applying more than a certain level of force at the control column on the pitch axis in all modes except in LAND Track mode and GO AROUND mode.

Later the AFS was modified to add a function of disengaging the AP against the case that the similar event would happen. Since then a force at the control column in ALT HOLD mode has not induced the automatic opposite action between the elevators and THS.

(2) January 9, 1989, A300B4-203FF type aircraft

According to the report issued by the Aircraft Accident Investigation Authority of Finland, while the aircraft was in approach phase with the AP engaged to Helsinki airport, CAP inadvertently triggered the Go Levers at 860 ft radio altitude.

This action activated the Go Around mode and led the ATS to increase the engine thrust automatically. A little later the CAP disconnected the ATS at the same time pulling the throttles to decrease the engine thrust. Because the CAP wanted to avoid the automatic pull-up which might be unpleasant for the passengers, he continued to push the control column counteracting the nose-up movement. This action led the AP to activate the Auto Trim in an attempt to keep the aircraft's nose-up attitude to command a nose-up movement of the THS to the opposite direction of the elevators movement.

The CAP disengaged the AP, or it was disengaged for an unknown reason. Until this time, the THS had already moved to 8° nose-up position. During the subsequent several seconds, the aircraft

flew in level flight at about 750 ft radio altitude while the CAP was pushing the control column. During the period, the CAP and F/O were convinced that the AP still was engaged.

The CAP reactivated ATS Go Around mode and interrupted the approach. This action led the engine thrust to increase, and led the aircraft to increase its pitch attitude and start climbing.

The crew pulled up flaps to 15°. The CAP pushed the control column to its full forward position. Simultaneously also the throttles were pushed to full forward position. The pitch attitude increased to 35.5° nose up and the speed decreased to 94 kts. The CAP did not use the electrical trim but started manual trimming and told the F/O to continue it.

Consequently the aircraft attitude and flight path were recovered. The recovery started at 2250 ft radio altitude and the aircraft recovered its normal flight at 1540 ft radio altitude while the pitch attitude was gradually reducing and the speed was also increasing.

(3) February 11, 1991, A310-304 type aircraft

According to the report of the German Authority of aircraft accident investigation, while the aircraft was making an ILS approach with the AP engaged to Moscow Airport, it was instructed by ATC when passing through approximately 1550 ft altitude to make go-around specifying a go-around altitude. The crew preselected 2260 ft as go-around altitude, and selected the go-around mode when it was at 1275 ft radio altitude.

Since the rate of climb was relatively high with the aircraft less gross weight, in order to alleviate the nose-up attitude that resulted from shifting into the go-around mode, the pilot pushed manually the control column to move the elevators toward the nose-down direction. In response to the pilot's action, the AP activated the Auto Trim function, which led the THS to move toward the nose-up direction in an attempt to maintain the climbing attitude in the go-around mode.

As a result of these opposite movement, the elevators moved to 14° nose-down position and the THS moved to 12° nose-up position. The ATS increased the engine thrust and retraction of the Flaps/Slats from full deflection to 15°, the aircraft commenced a steep climb.

When the aircraft reached 1503 ft altitude, the AP automatically changed the mode to the ALT Acquire. The crew still kept pushing the control column at this time. This action led the AP to disengage.

However, the THS remained the position as it was. Since the engine thrust also remained in an increased level, the pitch angle reached 88° and the speed decreased to 30 kt. This led the aircraft to stall condition when reaching 4327 ft altitude. The aircraft descended to 1487 ft and then climbed again. The aircraft subsequently repeated the cycle of stall, descent and steep climb. The altitude increased each time the aircraft climbed in the cycle, and the aircraft reached 11755 ft pressure altitude at a time of fourth climb. During the period, the crew believed that the AP was still engaged and did not recognized the out-of-trim condition of the THS.

The aircraft recovered from the abnormal flight condition at 8715 ft pressure altitude because the crew reduced the engine thrust at the time of forth descent in the cycle and involuntary activated the electric trim, and because of the THS trimming to the nose-down direction.

(4) September 24, 1994, A310-325 type Aircraft

A preliminary report about the serious incident of the A310 YR-LCA on September 24 1994 at Orly issued by the Aircraft Accident Investigation Authority in France is shown as follow;

From Bucarest to Paris Orly in schedule commercial flight, the A310 registered YR-LCA contacts Orly ATC at 10 h 37 mn. The weather conditions are VMC.

The Captain(PF), for demonstration, wants to perform an automatic approach ILS :

both A/P and A/THR are ON. The altitude for missed approach(4000') is selected on the FCU.

Due to the aircraft trajectory, the A/P does not intercept the glide path immediately. The PF disconnects the A/P but the A/THR remains engaged. The PF continues the approach in manual with V/S and LOC modes selected. The slats and flaps are selected 15-0, 15-15 and the gear is down.

As the aircraft crosses 1700 feet in descent at about 197 knots. The crew selects slats and flaps at 20-20.

Due to excessive speed (2 kts above VFE), there is a reversion mode from V/S and LOC to LVL/CHG and Heading Hold. The crew does not identify the mode reversion and the power levers go forward with a 1°/sec rate.

Twenty seconds later, the N1 reaches 81% (TRA 63°) and the crew retards the power lever from 63° to 38° in two seconds.

Then there is a pilot action on the pitch trim to nose up (the WHOOLER is heard on the CVR during 10 seconds) from -4.4° to -12.7° while the elevators from +3.7° to +14.7° nose down and the power levers go forward from 40° to 84° (TRA) in three seconds (104% de N1). The combination of the thrust increase and out of trim creates an important pitch up moment and the pitch of the aircraft increases from +6° to 59°.

The aircraft climbs to 4000 feet (rate about 11000'/mn) and stalls (stall warning is heard in the CVR), Alpha trim protection is activated (pitch trim moves from -12.7° to -8.8°). There are A/P and pitch trim disconnections due to the temporary loss of angle of attack information. During the stall, the crew retracts the gear and slats/flaps at 15°/0.

The crew recovers the stall at 830 feet. The aircraft flies during 30 seconds with the stabilizer deflection full nose up (-12.7°) and the elevator deflection full nose down (+14.7°) before the crew selects again the pitch trim levers on and corrects the pitch trim position (using the electrical pitch trim button). The crew performs a second pattern and lands without other problem.

The occurrence of this incident is not attributed to the AP override, but is directly attributed to the manual nose-up out-of-trim caused by pilot action on electric trim button while he was pushing on the control column.

In view of the incident, DGAC notified the civil aviation authorities on October 14, 1994 to recommend that the attention of all A310 and A300-600 operators is drawn on the following:

- strict compliance to the operating speed limits must be maintained.
- information of the crews on the operating logics and characteristics of the autoflight system of the A310 and A300-600 airplanes must be developed and periodically refreshed.
- check that the crew procedures, the associated documentation and their interpretation by the crew provide an effective protection against similar events.

2. Measures taken by Airbus Industrie (See table for Appendix 3)

- (1) In view of the incident of the A300-600 type aircraft which occurred on March 1, 1985, Airbus Industrie issued, in June 1985, Operations Engineering Bulletin (OEB 29/1) pertaining to the cautions regarding the AP override of A300-600 type aircraft.

Also, on March 18, 1988, Airbus Industrie introduced an FCC modification plan (MOD.7187) for the AFS on A300-600 type aircraft to allow the AP to be disconnected by applying a force

greater than 15 Kgf at the control column on the pitch axis in all modes except in Go AROUND and LAND Track modes. This modification was applied for the newly manufactured aircraft. In June, 1988, the Flight Crew Operating Manual (FCOM) for the A300-600 type aircraft was revised in accordance with the FCC modification (MOD.7187).

- (2) On March 9, 1989, Airbus Industrie issued a Technical Note (AI/E-VON° 472447/89) on the incident of the A300B4-203FF aircraft which occurred on January 9, 1989.

The FCC modification (MOD.7187) was planned to be accomplished simultaneously with the modification of the optional Wind Shear Warning System (SB A300-22-6009, dated June 1, 1989). In May, 1990, at the Airbus Operators Conference, the Airbus Industrie explained to operators how to avoid an out-of-trim situation in A300-600 and A310 type aircraft.

Furthermore, in January 1991, the Airbus Industrie added "Cautions" shown in Appendix 2-2 and 2-4 to FCOM for A300-600 type aircraft, and in March 1991, issued Operator Information Telexes (OIT ST/999.0036/91 and 0048/91) pertaining to the information and the operation procedures on the A300-304 type aircraft's incident occurred in Moscow on February 11, 1991.

In June, 1991, Airbus Industrie issued a bulletin (FCOM Bulletin 05/1) which calls attention to flight crews in the event of an AP override.

- (3) In view of similar three incidents having occurred, Airbus Industrie issued an SB A300-22-6021 on June 24, 1993, which, in addition to the modification of MOD 7187, introduced a modification to allow the AP to be disconnected by applying a force greater than 15 Kgf at the control column on the pitch axis in Go Around mode above 400 ft radio altitude.

The modified FCCs were incorporated into the newly manufactured aircraft. The modification specified in SB A300-22-6021 was categorized as "Recommended" to Operators. (See Attached Sheets for Appendix 3)

After the accident of China Airlines A300-600R which occurred at Nagoya Airport on April 26, 1994, Airbus Industrie disseminated the technical information regarding Cautions on overriding the AP to operators on May 5, 1994. On December 13, 1994, FCCs modification (SB A300-22-6021) was rendered mandatory in accordance with airworthiness directive issued by DGAC as of August 17, 1994.

Table for Appendix 3 Examples of previous incidents
and Measures taken after the incidents

ACCIDENTS / INCIDENT	Airbus Industrie actions
① March 1, 1989 A300 - 600	<p data-bbox="858 456 1401 517">June 1985 : OEB 29/1 Issued</p> <p data-bbox="858 539 1401 689">March 18, 1988: MOD. 7187 to make AP disconnection possible by force on control wheel except in LAND Track and GA mode</p> <p data-bbox="858 696 1401 748">June 1988 : FCOM Revised</p>
② Jan. 9, 1989 A300B4 - 203FF : Helsinki	<p data-bbox="858 819 1241 880">March 9, 1989: T.N. Issued</p> <p data-bbox="1098 902 1513 963">June 1, 1989 : SB 6009 Issued</p> <p data-bbox="858 992 1401 1052">May 1990 : Operators Conference</p> <p data-bbox="858 1081 1401 1133">Jan. 1991: CAUTION added to A300-600 FCOM</p>
③ Feb. 11, 1991 A310 : Moscow	<p data-bbox="858 1234 1145 1294">Mar. 1991: OIT Issued</p> <p data-bbox="1161 1234 1513 1294">CAUTION added to A310 FCOM</p> <p data-bbox="858 1323 1369 1384">June 1991 : FCOM Bulletin Issued</p> <p data-bbox="858 1413 1369 1525">June 24, 1993: SB 6021 ("Recommended") for AP disconnection at 15 Kg force on control wheel, GA mode above R.ALT 400ft</p>
CAL accident in NAGOYA : JAPAN April 26, 1994 A300-600	<p data-bbox="858 1648 1257 1709">May 5, 1994 T.I. Issued</p> <p data-bbox="1066 1738 1513 1798">Aug. 17, 1994 : DGAC CN(AD) Issued</p> <p data-bbox="858 1827 1377 1917">Dec. 13, 1994 : SB 6021 Revised from "Recommended" to "Mandatory".</p>

AIRBUS INDUSTRIE
 PRODUCT SUPPORT DIRECTORATE
 1 Rond Point. Maurice BELLONTE
 31707 BLAGNAC CEDEX FRANCE
 Tel : (33) 61-93-33-33
 Telex : AIRBU 530526 F

 **A300-600**

SERVICE BULLETIN

MODIFICATION No. 10403S20537, S20624

ATA SYSTEM : 22

TITLE : AUTO FLIGHT - FCC - UPGRADE SOFTWARE CONTROL LAW FOR A300-600.

1. PLANNING INFORMATION

A. EFFECTIVITY

(1) Aircraft models : B4-601, B4-603, B4-605R, B4-622, B4-622R, C4-620.

(2) Aircraft

Customer and Fleet No.	MSN	Kit No.	Qty of Kits
			None
AAL050-084	423, 459, 460, 420, 461, 462, 463, 465, 466, 469, 470, 471, 474, 506, 507, 508, 509, 510, 511, 512, 513, 514, 515, 516, 517, 606, 610, 612, 615, 619, 626, 639, 643, 645, 675		
AH001-008	611, 613, 630, 633, 664, 668, 688, 690		
CAL601-606	529, 533, 536, 578, 580, 666		
CCA601-604	521, 525, 532, 707		
DLH601-611	380, 391, 401, 405, 408, 411, 414, 546, 553, 618, 623		
JAS001-009	602, 617, 621, 637, 641, 670, 679, 683, 703		
KAC601-603	673, 694, 699		
KAL501-503	361, 365, 358		
KAL551-566	477, 479, 388, 417, 543, 554, 560, 582, 583, 609, 614, 627, 631, 662, 685, 692		
MON001-004	540, 556, 604, 605		

5 DATE : Jun 24/93

SERVICE BULLETIN No. : A300-22-6021

REVISION No. = 1 - Dec 24/93

PAGE : 1 of 9

Printed in France

A300-600

SERVICE BULLETIN

Customer and Fleet No.	MSN	Kit No.	Qty of Kits
MSR001-009	557,561,572,575,579,581,601,607,616		None
OAL001,002	632,696		
RF001	354		
RF051	374		
SVA001-011	284,294,301,307,312,317,321,336,341,348,351		
THA051-066	368,371,377,384,395,398,464,518,566,569,577,628,629,635,681,705		
UAE101-105	505,558,563,608,701		
XF601,602	555,559		
XF701,702	625,677		
XJ001,002	657,659		
X0001,002	584,603		
XQ001	252		
XQ051	530		

This modification is embodied prior to delivery on A/C MSN 709 and subsequent.

NOTE 1 : Accomplishment of this Service Bulletin requires the previous or simultaneous accomplishment of Service Bulletin No. A300-22-6009 (Modification No. 7187S7843) and Service Bulletin No. A300-22-6020 (Modification No. 7187S7843) valid for SVA and RF.

(3) Spares

None.

DATE : Jun 24/93

REVISION No. : 1 - Dec 24/93

SERVICE BULLETIN No. : A300-22-6021

PAGE : 2

Printed in France

A300-600

SERVICE BULLETIN

B. REASON

(1) History

This Service Bulletin is published to advise operators of all A300/600 concerned of the issue of SEXTANT AVIONIQUE Service Bulletin No. B470AAM-22-007.

(2) Objective/Action

To provide autopilot disengagement by applying a 15daN force on the control column in go-around mode above 400 feet (radio altitude) this Service Bulletin recommends to modify the software of both Flight Control Computers.

The modified Flight Control Computers will also include improvements which have been identified from the last standard.

(3) Advantages

Operational benefits and/or passenger confort by :

- autopilot disengagement by 15daN force on control column during go-around above 400 feet (radio altitude),
- avoidance of unwanted autopilot disengagement when the pilot takes firmly the control column,
- nose down improvement to avoid the pitch attitude increase after main landing gear touch down,
- improvement of "LEVEL CHANGE" mode to avoid the "VMO" overshoot,
- "ALT HOLD" mode improvement in heavy turbulence.
- improvement of autopilot capacity to counteract strong vertical gust in cruise.

(4) Accomplishment Timescale

Accomplishment of this Service Bulletin is recommended at the earliest opportunity where manpower and facilities are available.

(5) Interchangeability/Mixability

Interchangeability : See Para. 3 - MATERIAL INFORMATION.

Mixability : Not applicable.

DATE : Jun 24/93

SERVICE BULLETIN No. : A300-22-6021

REVISION No. : 1 - Dec 24/93

PAGE : 3

Printed in France

A300-600

SERVICE BULLETIN

NOTE : Only the interchangeability and mixability configurations and conditions expressly mentioned in this Service Bulletin are endorsed by Airbus Industrie.
Should airlines wish to install any other configuration, they must contact Airbus Industrie beforehand.

C. DESCRIPTION

Accomplishment of this Service Bulletin consists in carrying out the following jobs on the aircraft :

In avionics compartment, zone 121, Left electronics rack, 80VU :

Modification of Flight Control Computers (FCC1 and FCC2).

D. APPROVAL

The design data contained in this Service Bulletin has been approved under the authority of DGAC Design Organisation Approval No. C 01. The changes specified in this Service Bulletin have been approved by the DGAC when they are major, or under the authority of DGAC Design Organisation Approval No. C 01, when they are minor.

E. MANPOWER

	<u>Manhours</u>	
	<u>Aircraft</u>	<u>Bench</u>
Removal/Installation of FCCs	1.0	
Modification		Refer to SEXTANT AVIONIQUE Service Bulletin No. B470AAM-22-007
Test	0.5	
TOTAL MANHOURS	1.5	
ELAPSED TIME (HOURS)	1.5	

NOTE : This Service Bulletin assumes that the aircraft has been placed in a maintenance status. The manhours/elapsed time estimates do not include preparation for the modification, non-productive elapsed time, or administrative functions.

DATE : Jun 24/93

SERVICE BULLETIN No. : A300-22-6021

REVISION No. : 1 - Dec 24/93

PAGE : 4

Printed in France

A300-600

SERVICE BULLETIN

F. MATERIAL - COST AND AVAILABILITY

Terms of procurement are to be negotiated directly with SEXTANT AVIONIQUE, as per SEXTANT AVIONIQUE Service Bulletin No. B470AAM-22-007.

G. TOOLING - PRICE AND AVAILABILITY

None.

H. WEIGHT AND BALANCE

None.

I. REFERENCES

Aircraft Maintenance Manual : 06-41-52, 22-18-34, 22-40-00, 24-00-00,
24-41-00

Service Bulletin No. A300-22-6009 (Mod. No. 7187S7843)

Sextant Avionique Service Bulletin No. B470AAM-22-007

J. PUBLICATIONS AFFECTED

Illustrated Parts Catalog : 22-18-08.

DATE : Jun. 24/93

SERVICE BULLETIN No. : A300-22-6021

REVISION No. : 1 - Dec 24/93

PAGE : 5-6

Printed in France

Appendix 4 Changes to AFSs on A300-600

AP		DISENGAGEMENT		OVERRIDE	
AP mode		LAND/GA	Others	LAND/GA	Others
R.ALT 400 ft or higher	At aircraft development	/	/	PITCH UP: 46Kg DOWN: 20 Kg ROLL : 15 Kg YAW : 65 Kg	PITCH UP: 46Kg DOWN: 20 Kg ROLL : 15 Kg YAW : 65 Kg
	1988.3 (MOD) 1989.6 (SB)	(Note 1) New function added. PITCH: 15 Kg (Can be disengaged in LAND mode only.) (Modified by MOD. 7187 and SB 6009)	(Note 2) New function added. PITCH: 15 Kg	(Note 3) PITCH : 46/20 Kg ROLL : 15 Kg YAW : 65 Kg	Function changed ROLL : 15 Kg YAW : 65 Kg
	1993.6 (SB) 1994.8 (AD)	* New function added PITCH: 15 Kg (GA added) (Modified by SB 6021)	PITCH: 15 Kg	Function changed PITCH: 15 Kg YAW : 65 Kg	ROLL: 15Kg YAW : 65 Kg
	* New function added to disengage AP in GA mode also when altitude is higher than 400 ft.				
Below 400 ft	At aircraft development	/	/	PITCH : 46/20 Kg ROLL : 15 Kg YAW : 65 Kg	PITCH : 46/20 Kg ROLL : 15 Kg YAW : 65 Kg
	1988.3 (MOD) 1989.6 (SB)	/	Function added PITCH: 15 Kg (Modified by MOD. 7187, SB 6009)	PITCH : 46/20 Kg ROLL : 15 Kg YAW : 65 Kg	Function changed ROLL : 15 Kg YAW : 65 Kg
	1993.6 (SB) 1994.8 (AD)	/	PITCH: 15 Kg	PITCH : 46/20 Kg ROLL : 15 Kg YAW : 65 Kg	ROLL : 15 Kg YAW : 65 Kg

* CW = Control Wheel

* MOD = Modification

* "OVERRIDE" refers to a condition in which the AP is temporarily overridden by operating the CW, but the AP remains engaged. (If the CW is operated in the pitch direction, there could be an out-of-trim condition.)

* The AP modes other than LAND TRACK and GA modes are ALT*, ALT, SPD, V/S, GS, P CLB, P DES, HDG, LOC, NAV, VOR, etc

Appendix 5 Airport Service Manual (Extract)

Airport Service Manual (Extract)

A I R P O R T S E R V I C E S M A N U A L P A R T I R E S C U E A N D F I R E F I G H T I N G

Chapter 2

Level of Protection to be Provided

2.4 CRITICAL AREA

2.4.1 The critical area is a concept for rescue of the occupants of an aircraft. It differs from other concepts in that, instead of attempting to control and extinguish the entire fire, it seeks to control only that area of fire adjacent to the fuselage. The objective is to safeguard the integrity of the fuselage and maintain tolerable conditions for its occupants. The size of the controlled area required to achieve this for a specific aircraft has been determined by experimental means.

2.4.2 There is a need to distinguish between the theoretical critical area within which it may be necessary to control the fire and the practical critical area which is representative of actual aircraft accident conditions. The theoretical critical area serves only as a means for categorizing aircraft in terms of the magnitude of the potential fire hazard in which they may become involved. It is not intended to represent the average, maximum or minimum spill fire size associated with a particular aircraft. The theoretical area is a rectangle having as one dimension the over-all length of the aircraft and as the other dimension a length which varies with the length and width of the fuselage.

2.4.3 From experiments performed it has been established that on aircraft with a fuselage length equal to or greater than 20

m, in wind conditions of 16 to 19 km/h and at right angles to the fuselage, the theoretical critical area extends from the fuselage to a distance of 24 m upwind and 6 m downwind. For smaller aircraft a distance of 6 m on either side is adequate. To provide for a progressive increase in the theoretical critical area, however, a transition is used when the fuselage length is between 12 m and 18 m.

2.4.4 The over-all length of the aircraft is considered appropriate for the theoretical critical area as the entire length of aircraft must be protected from burning. If not, the fire could burn through the skin and enter the fuselage. Also, other aircraft such as T-tail aircraft often have engines or exit points in this extended portion.

2.4.5 The formula for the theoretical critical area A_T thus becomes:

Over-all length	Theoretical critical area A_T
$L < 12 \text{ m}$	$L \times (12 \text{ m} + W)$
$12 \text{ m} \leq L < 18 \text{ m}$	$L \times (14 \text{ m} + W)$
$18 \text{ m} \leq L < 24 \text{ m}$	$L \times (17 \text{ m} + W)$
$L \geq 24 \text{ m}$	$L \times (30 \text{ m} + W)$

where L = the over-all length of the aircraft, and

W = the width of the aircraft fuselage.

2.4.6 As mentioned earlier, in practice it is seldom that the entire theoretical critical area is subject to fire and a smaller area, for which it is proposed to provide fire fighting capacity, is referred to as the practical critical area.

As a result of a statistical analysis of actual aircraft

accidents, the practical critical area A_p has been found to be approximately two-thirds of the theoretical critical area, or

$$A_p = 0.667 A_T$$

2.4.7 The quantity of water for foam production can be calculated from the following formula:

$$Q = Q_1 + Q_2$$

where Q = the total water required

Q_1 = the water for control of the fire in the practical critical area, and

Q_2 = the water required after control has been established and is needed for such factors as the maintenance of control and/or extinguishment of the remaining fire.

2.4.8 The water required for control in the practical critical area (Q_1), may be expressed by the following formula:

$$Q_1 = A \times R \times T$$

where A = the practical critical area

R = the rate of application, and

T = time of application.

2.4.9 The amount of water required for Q_2 cannot be calculated exactly as it depends on a number of variables.

The factors considered of primary importance are:

- a) maximum gross mass of the aircraft;
- b) maximum passenger capacity of the aircraft;
- c) maximum full load of the aircraft; and
- d) previous experience (analysis of aircraft rescue and fire fighting operations).

These factors, when plotted on a graph, are used to calculate the total amount of water required for each airport category. The volume of water for Q_2 , as a percentage of Q_1 , varies from about 0 per cent for category 1 airports to about 170 per cent for an airport category 9.

2.4.10 The graph mentioned in the preceding paragraph gives the following approximate values for aeroplanes representative of each airport category:

A irport category	$Q_2 =$ percentage of Q_1 percentage
1	0
2	27
3	30
4	58
5	75
6	100
7	129
8	152
9	170

Appendix 6 DFDR Records

LANDING GEAR DOWN NOSE (non-line=down&lock)
LANDING GEAR DOWN LH (non-line=down&lock)
LANDING GEAR DOWN RH (non-line=down&lock)

SLATS POSITION (degree)

FLAPS POSITION (degree)

ELEVATOR POSITION (degree)
<0=nose up

STABILIZER POSITION (degree)
<0=nose up

RADIO ALTITUDE (ft)

ANGLE OF ATTACK (degree)*NON-CALIBRATION
>0=up

PITCH ANGLE (degree)
>0=nose up

MIDDLE MARKER (line=receive)
OUTER MARKER (line=receive)
AUTO PILOT ENGAGE 2 COMMAND (line=on)
AUTO PILOT ENGAGE 1 COMMAND (line=on)
VHF-1 (non-line=transmit)

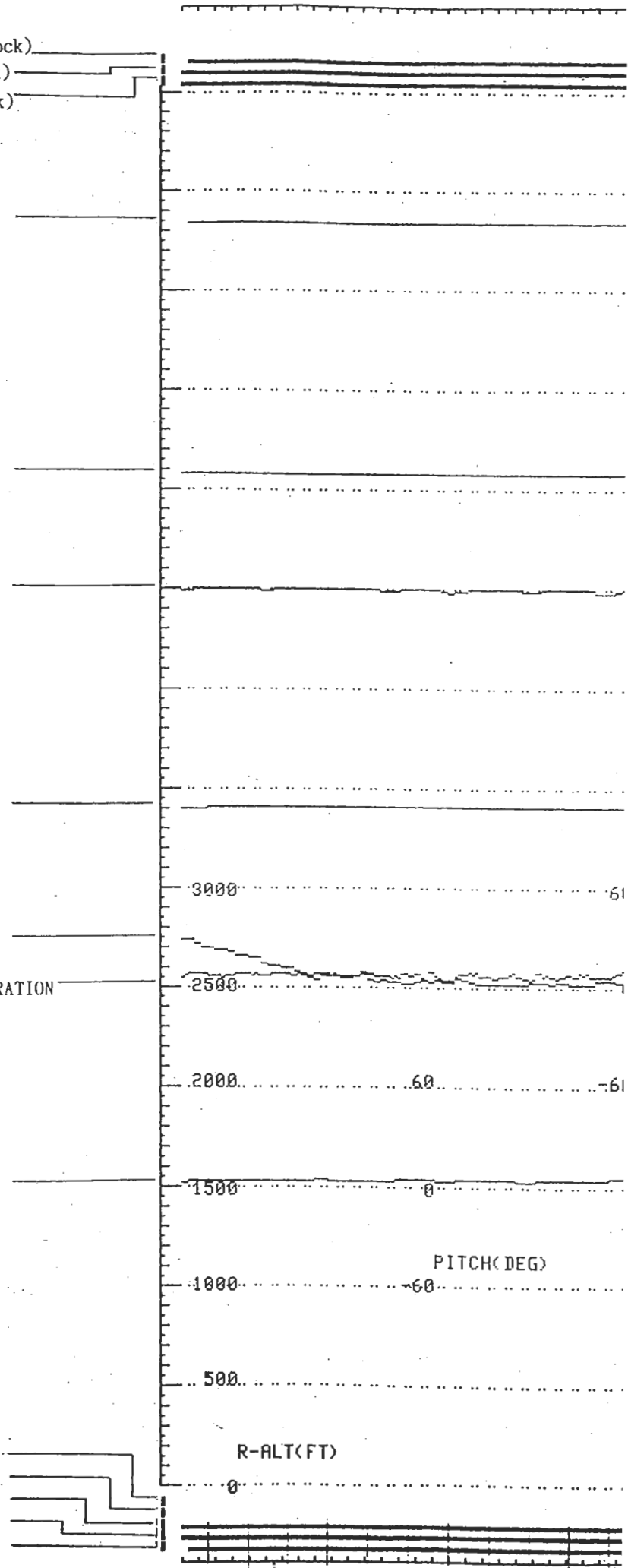

11:08(UTC)

25

SLATS(DEG)

0

50

FLAPS(DEG)

25

0

ELEV(DEG)

12.5

-25

0

STAB(DEG)

-12.5

D.A(DEG)

11:09

11:10

11:11

11:11'30"

A93 ~ A94

LANDING GEAR DOWN NOSE (non-line=down&lock)
LANDING GEAR DOWN LH (non-line=down&lock)
LANDING GEAR DOWN RH (non-line=down&lock)

SLATS POSITION (degree)

FLAPS POSITION (degree)

ELEVATOR POSITION (degree)
<0=nose up

STABILIZER POSITION (degree)
<0=nose up

ANGLE OF ATTACK (degree) *NON-CALIBRATION
>0=up

RADIO ALTITUDE (ft)

PITCH ANGLE (degree)
>0=nose up

MIDDLE MARKER (line=receive)
OUTER MARKER (line=receive)
AUTO PILOT ENGAGE 2 COMMAND (line=on)
AUTO PILOT ENGAGE 1 COMMAND (line=on)
VHF-1 (non-line=transmit)

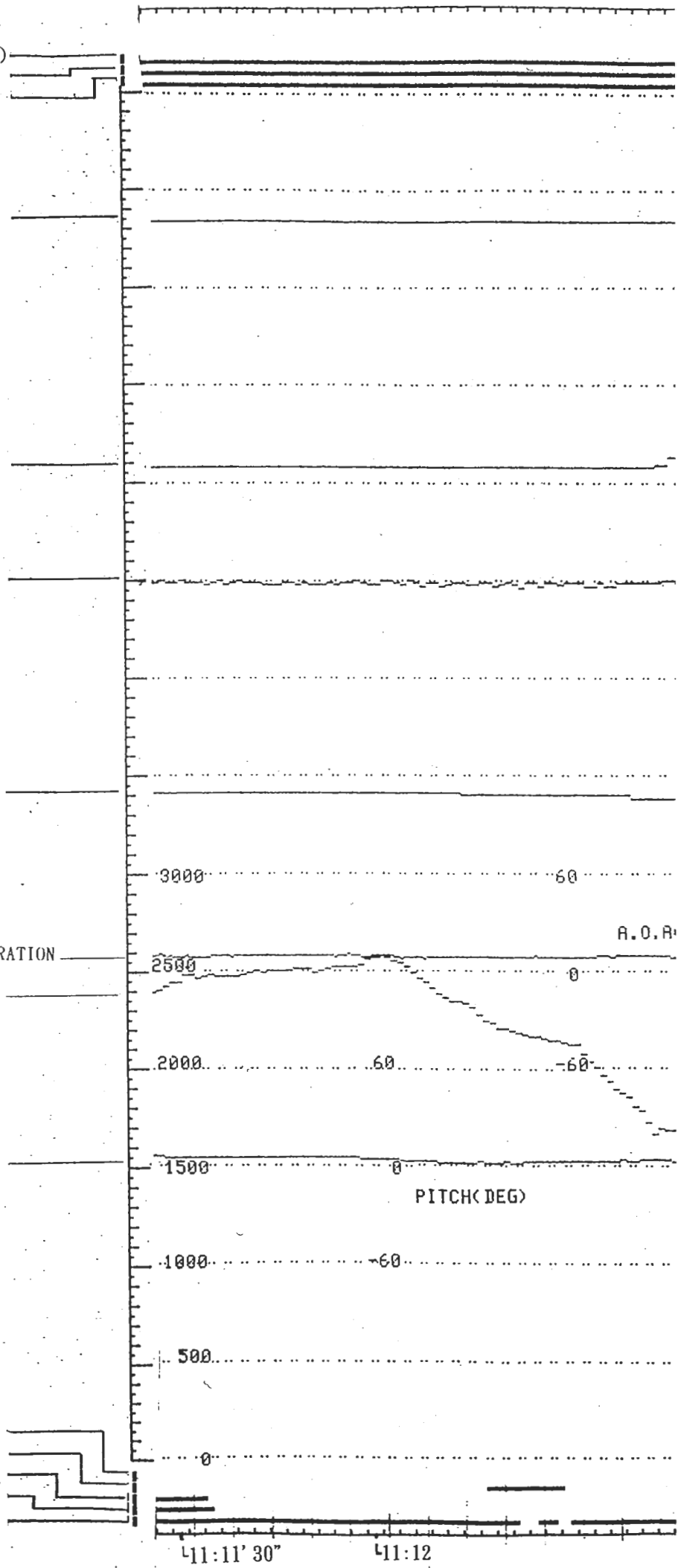

11:11' 30'' 11:12

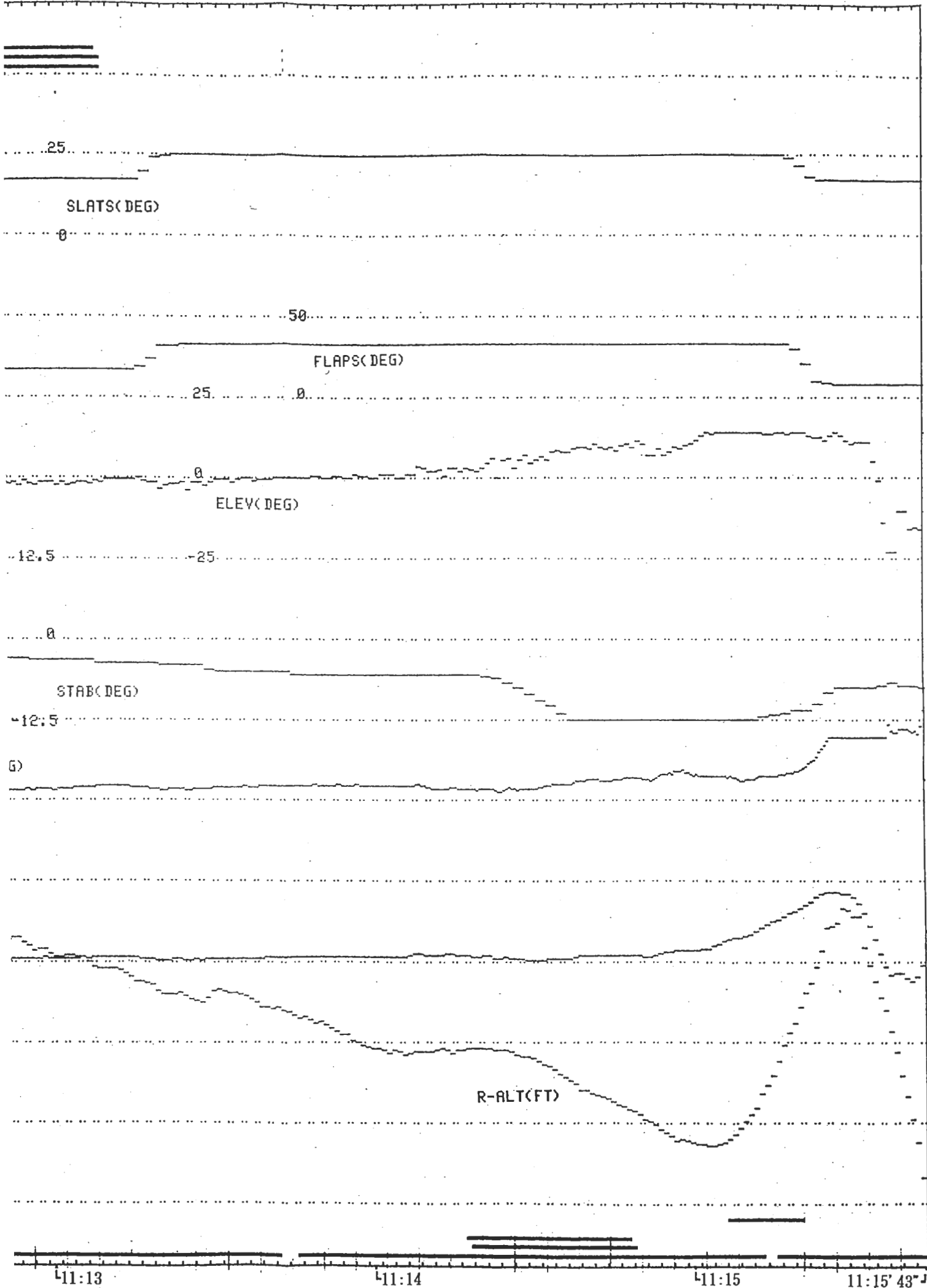

SPOILER 7 LH (non-line=deploy)
SPOILER 6 LH (non-line=deploy)
SPOILER 5 LH (non-line=deploy)
SPOILER 4 LH (non-line=deploy)
SPOILER 3 LH (non-line=deploy)

LATERAL ACCELERATION (G)
>0=RH side slip

AILERON POSITION LH (degree)
<0= LHaileron up

AILERON POSITION RH (degree)
<0= RHaileron up

RUDDER ANGLE (degree)
>0=turn left

ROLL ANGLE (degree)
<0= RH wing up

LOCALIZER DEVIATION (DOT)
>0=plane left of beam

MAGNETIC HEADING (degree)

SPOILER 3 RH (non-line=deploy)
SPOILER 4 RH (non-line=deploy)
SPOILER 5 RH (non-line=deploy)
SPOILER 6 RH (non-line=deploy)
SPOILER 7 RH (non-line=deploy)

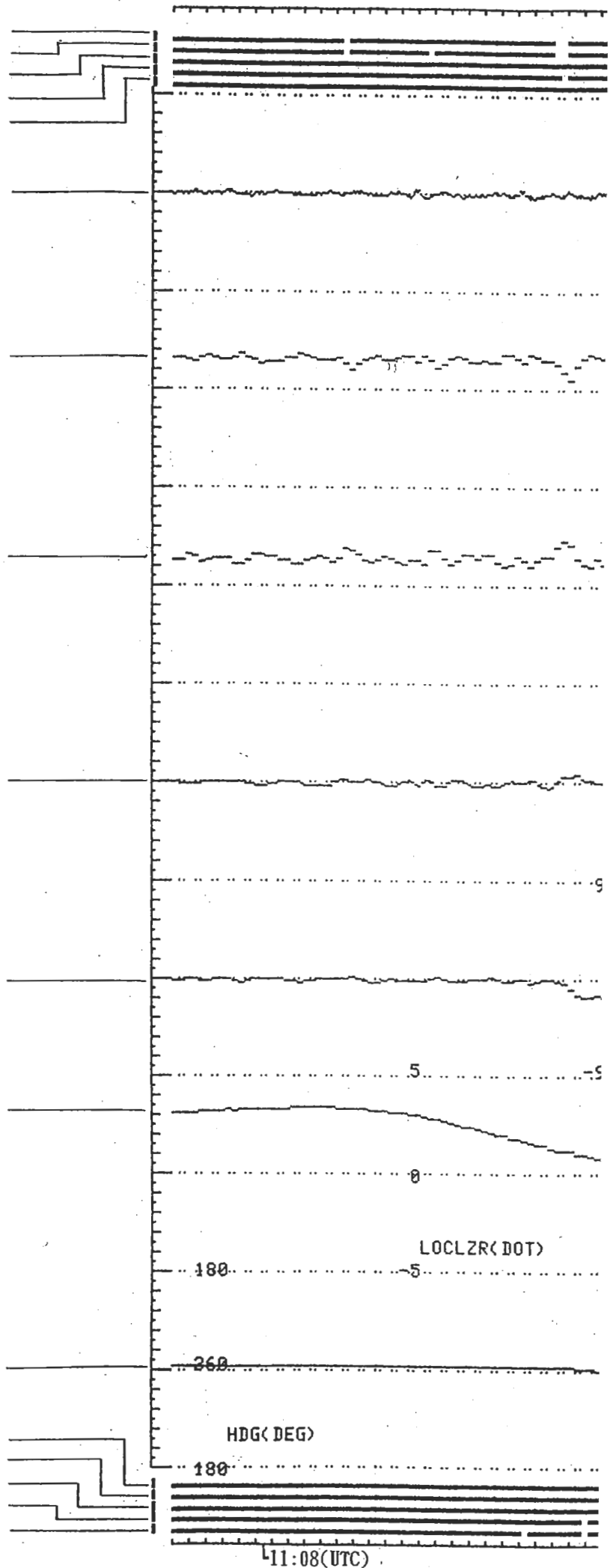

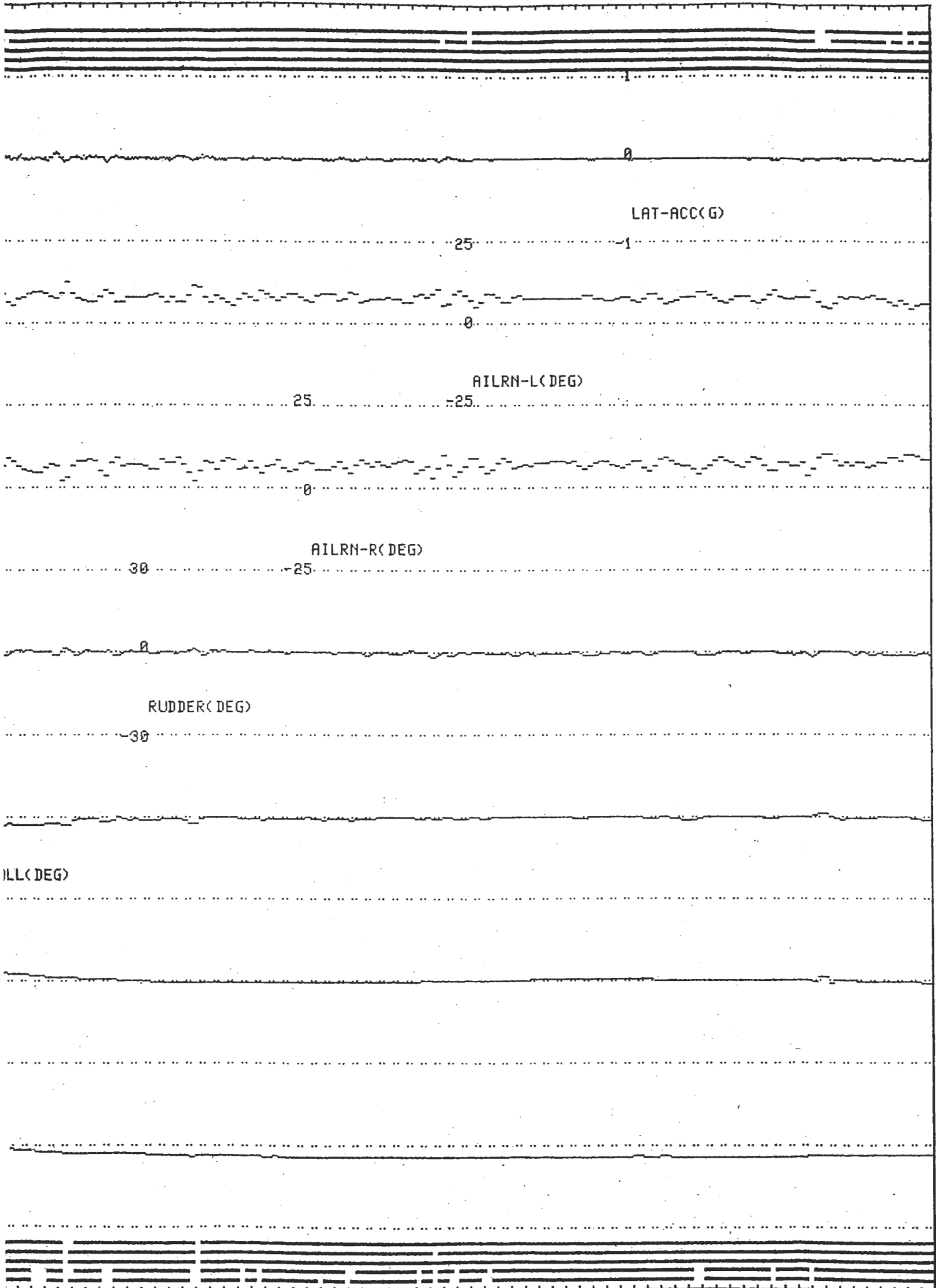

11:09

11:10

11:11

11:11' 30"

A97 ~ A98

SPOILER 7 LH (non-line=deploy)
SPOILER 6 LH (non-line=deploy)
SPOILER 5 LH (non-line=deploy)
SPOILER 4 LH (non-line=deploy)
SPOILER 3 LH (non-line=deploy)

LATERAL ACCELERATION (G)
>0=RH side slip

AILERON POSITION LH (degree)
<0=LH aileron up

AILERON POSITION RH (degree)
<0=RH aileron up

RUDDER ANGLE (degree)
>0=turn left

ROLL ANGLE (degree)
<0=RH wing up

LOCALIZER DEVIATION (DOT)
>0=plane left of beam

MAGNETIC HEADING (degree)

SPOILER 3 RH (non-line=deploy)
SPOILER 4 RH (non-line=deploy)
SPOILER 5 RH (non-line=deploy)
SPOILER 6 RH (non-line=deploy)
SPOILER 7 RH (non-line=deploy)

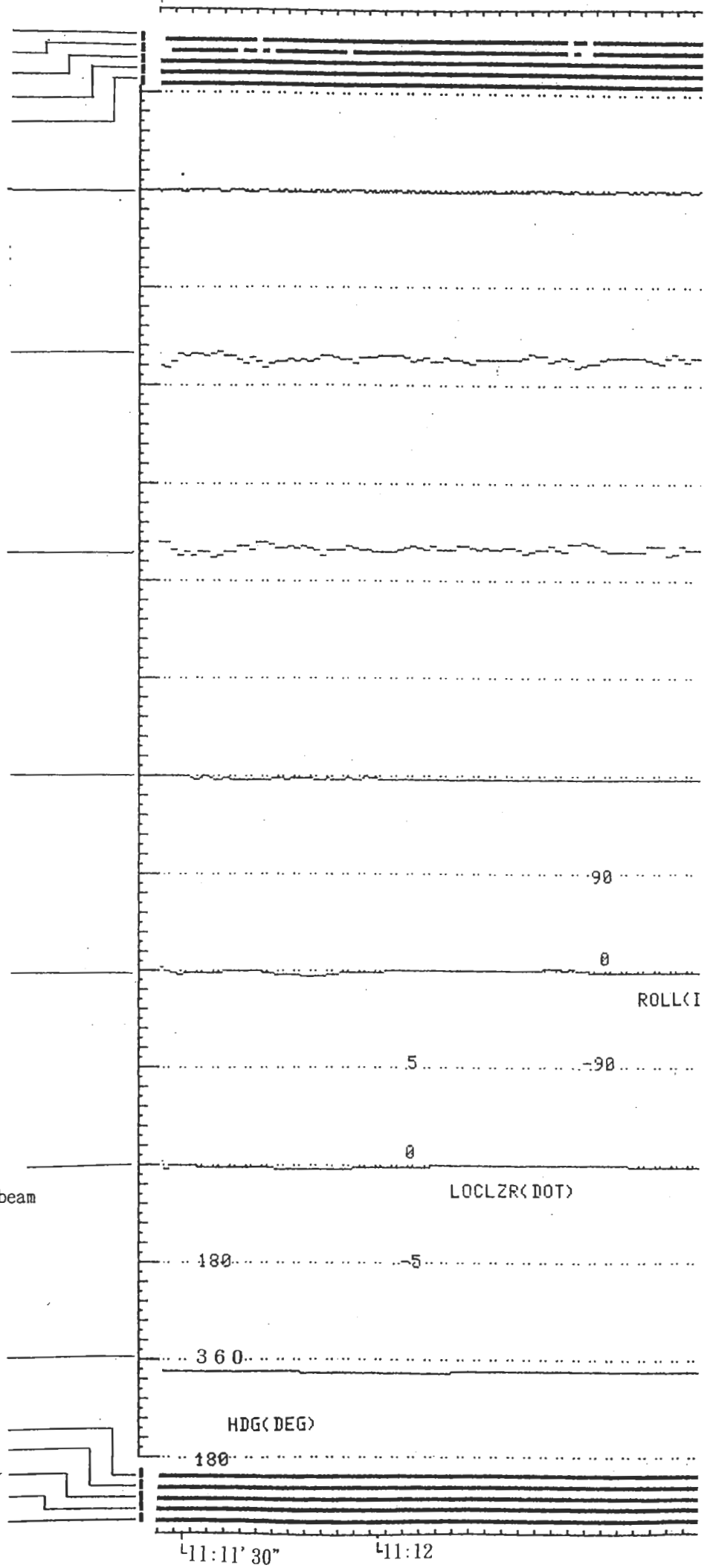

11:11' 30" 11:12

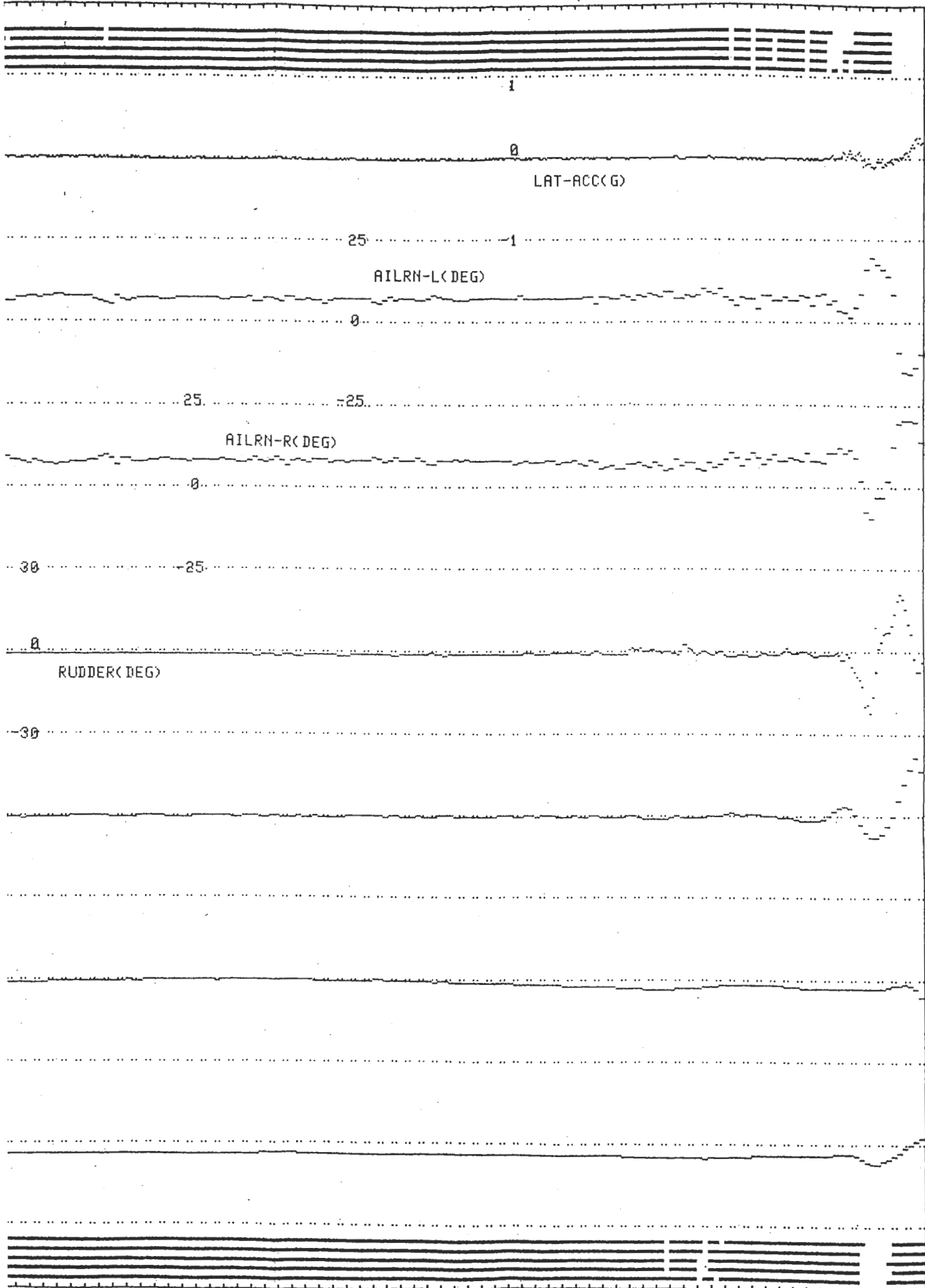

11:13

11:14

11:15

11:15' 43"

A99 ~ A100

SPOILER 2 LH(non-line=deploy)
SPOILER 1 LH(non-line=deploy)

LONGITUDINAL ACCELERATION (G)
<0=acceleration

VERTICAL ACCELERATION (G)
>0=up

GLIDE SLOPE DEVIATION (DOT)
>0=plane above of beam

LOCALIZER DEVIATION (DOT)
>0=plane left of beam

COMPUTED AIRSPEED (kt)

RADIO ALTITUDE (ft)

PITCH ANGLE (degree)
>0=nose up

SPOILER 1 RH(non-line=deploy)
SPOILER 2 RH(non-line=deploy)
AUTO PILOT ENGAGE 2 COMMAND(line=on)
AUTO PILOT ENGAGE 1 COMMAND(line=on)
VHF-1(non-line=transmit)

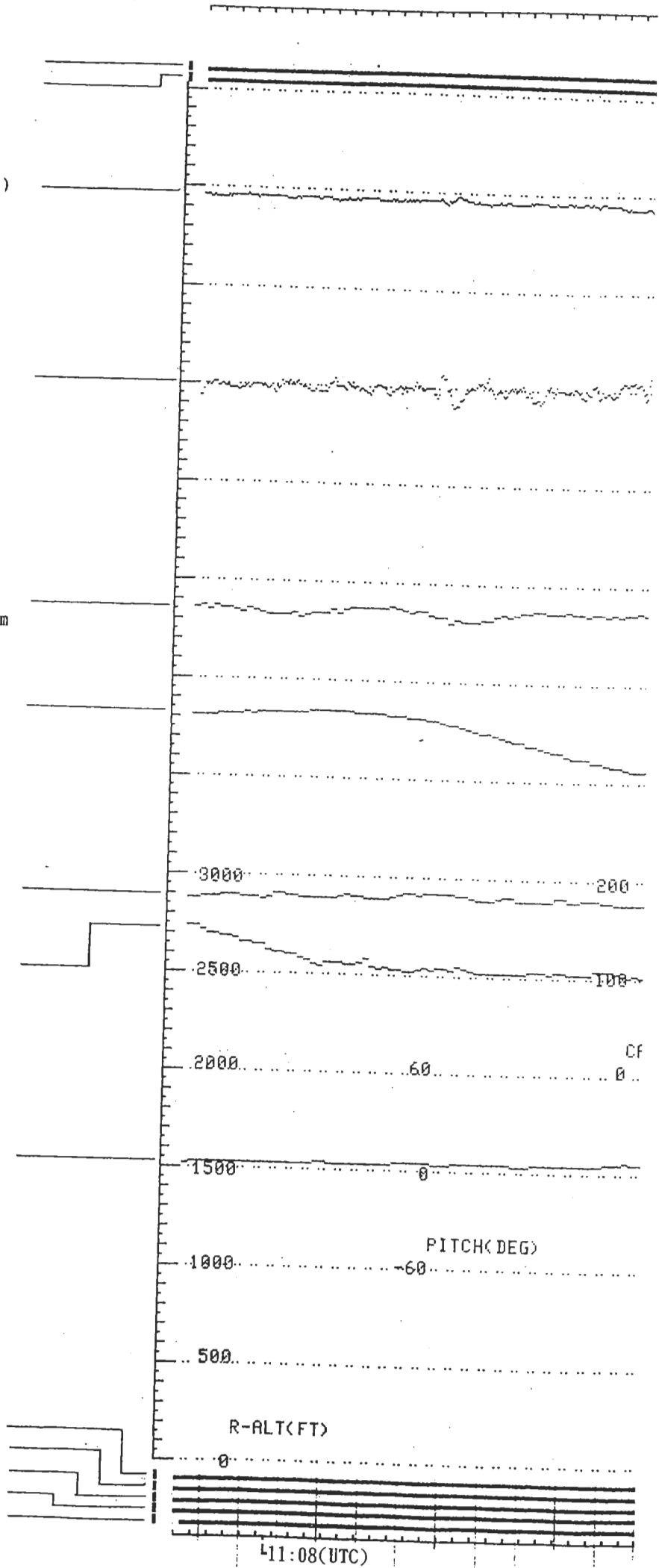

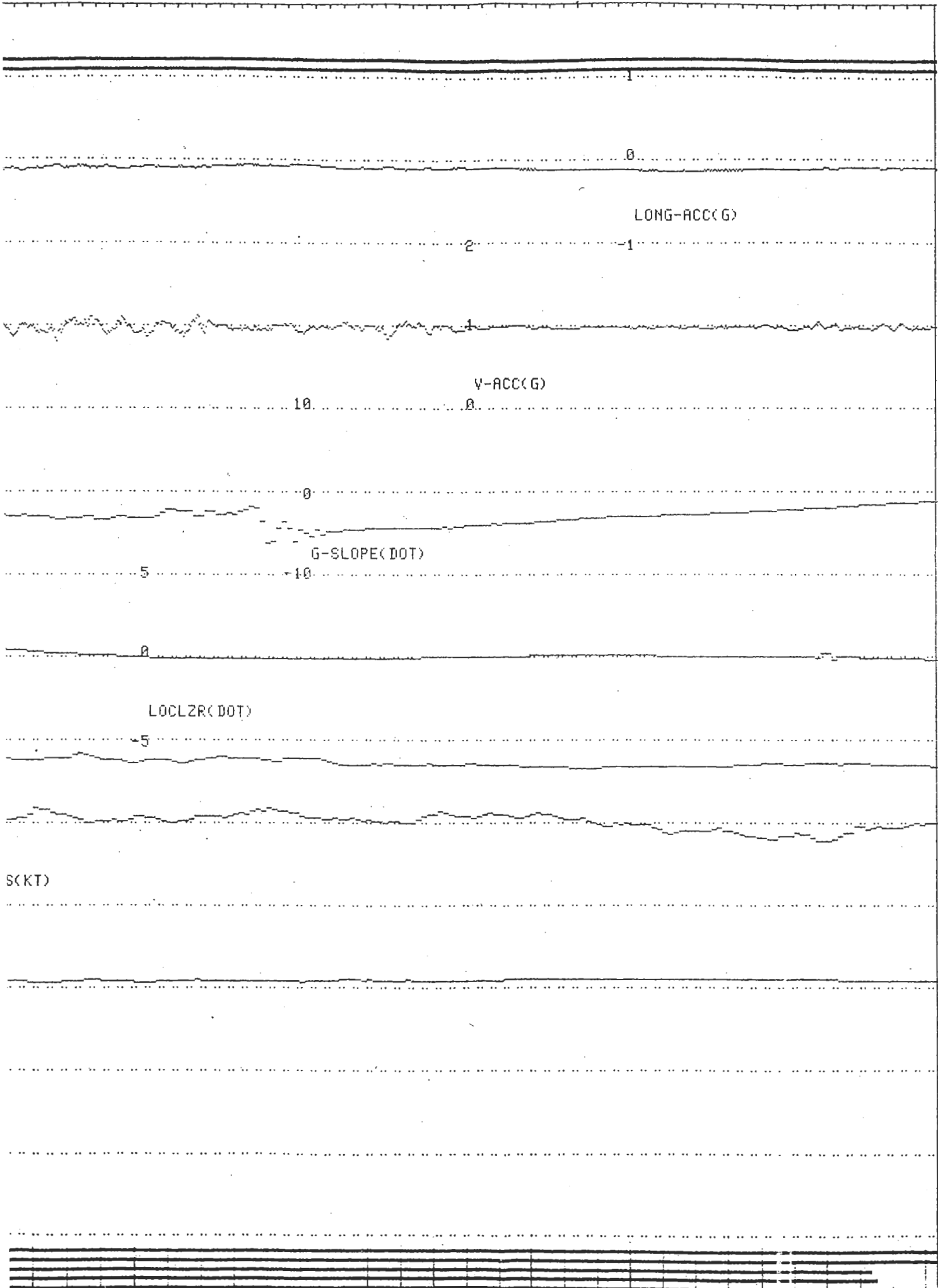

11:09

11:10

A101 ~ A102

11:11

11:11' 30"

SPOILER 2 LH(non-line=deploy)
SPOILER 1 LH(non-line=deploy)

LONGITUDINAL ACCELERATION (G))
<0=acceleration

VERTICAL ACCELERATION (G)
>0=up

GLIDE SLOPE DEVIATION (DOT)
>0=plane above of beam

LOCALIZER DEVIATION (DOT)
>0=plane left of beam

COMPUTED AIRSPEED (kt)

RADIO ALTITUDE (ft)

PITCH ANGLE (degree)
>0=nose up

SPOILER 1 RH(non-line=deploy)
SPOILER 2 RH(non-line=deploy)
AUTO PILOT ENGAGE 2 COMMAND(line=on)
AUTO PILOT ENGAGE 1 COMMAND(line=on)
VHF-1(non-line=transmit)

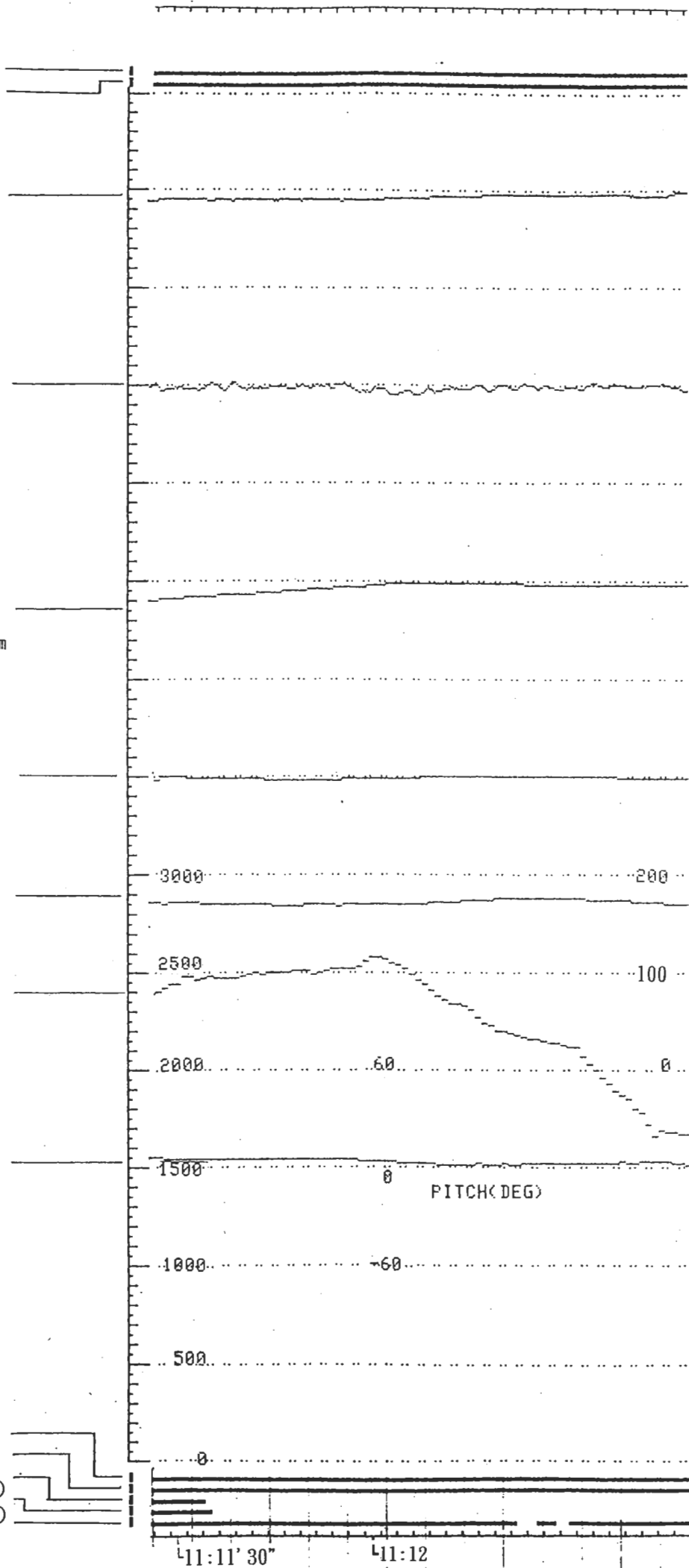

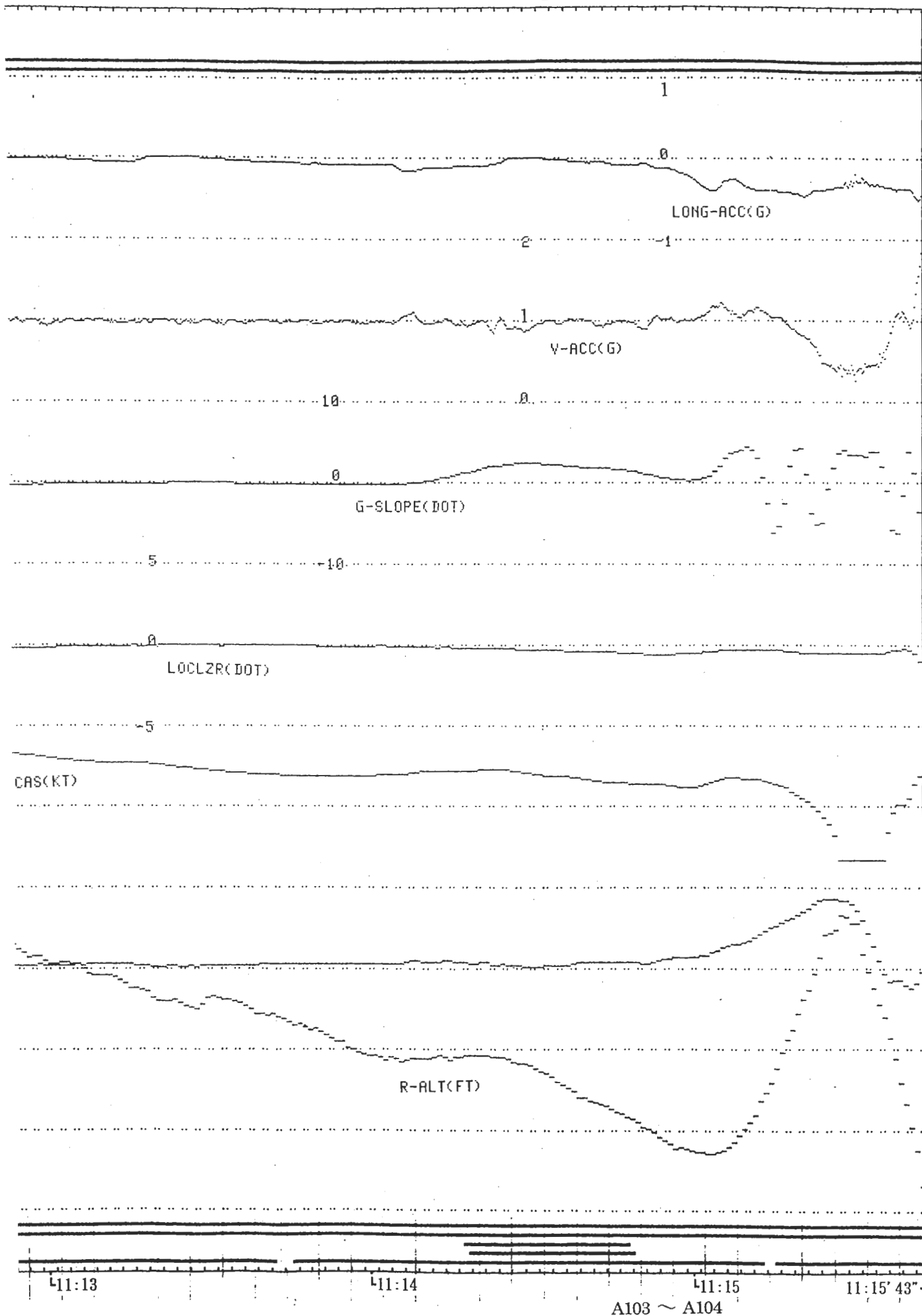

THROTTLE RESOLVER ANGLE ENGINE1 (degree)

THROTTLE RESOLVER ANGLE ENGINE2 (degree)

ENGINE PRESSURE RATIO ENGINE1

ENGINE PRESSURE RATIO ENGINE2

COMPUTED AIRSPEED (kt)

PRESSURE ALTITUDE (ft)

PITCH ANGLE (degree)
>0=nose up

MIDDLE MARKER (line=receive)
OUTER MARKER (line=receive)
AUTO PILOT ENGAGE 2 COMMAND (line=on)
AUTO PILOT ENGAGE 1 COMMAND (line=on)
VHF-1 (non-line=transmit)

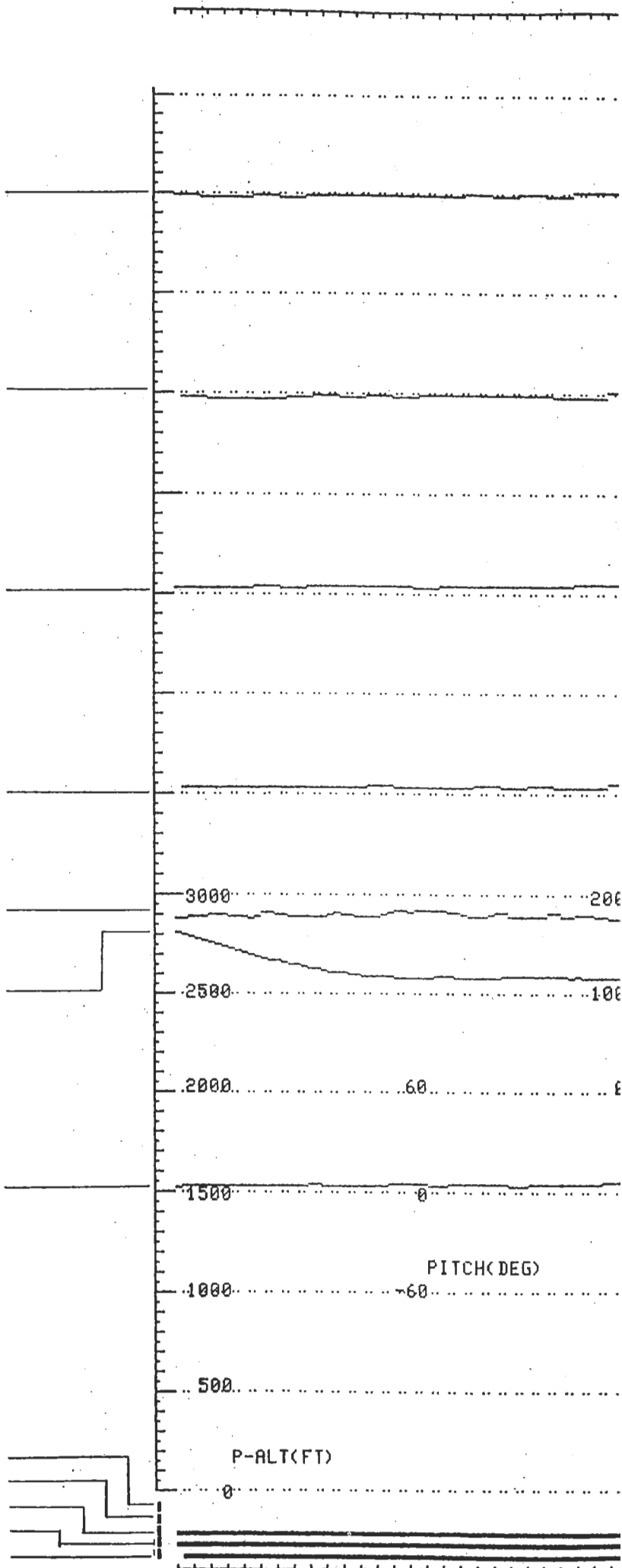

11:08(UTC)

100

50

T.R.A#1(DEG)

100

0

50

T.R.A#2(DEG)

2

0

EPR #1

2

0

EPR #2

0

(KT)

11:09

11:10

11:11

11:11' 30"

A105 ~ A106

THROTTLE RESOLVER ANGLE ENGINE1 (degree)

THROTTLE RESOLVER ANGLE ENGINE2 (degree)

ENGINE PRESSURE RATIO ENGINE1

ENGINE PRESSURE RATIO ENGINE2

COMPUTED AIRSPEED (kt)

PRESSURE ALTITUDE (ft)

PITCH. ANGLE (degree)
>0=nose up

MIDDLE MARKER (line=receive)

OUTER MARKER (line=receive)

AUTO PILOT ENGAGE 2 COMMAND (line=on)

AUTO PILOT ENGAGE 1 COMMAND (line=on)

VHF-1 (non-line=transmit)

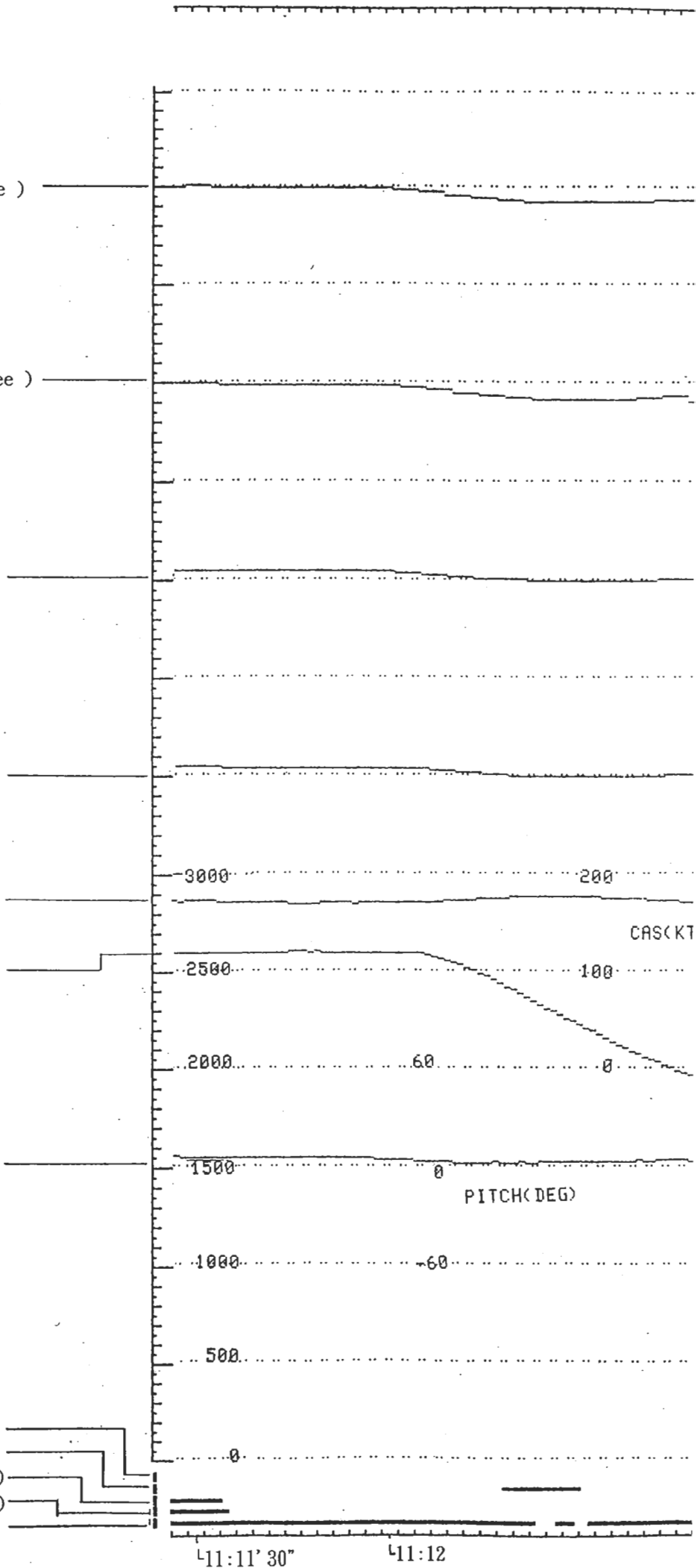

11:11' 30''

11:12

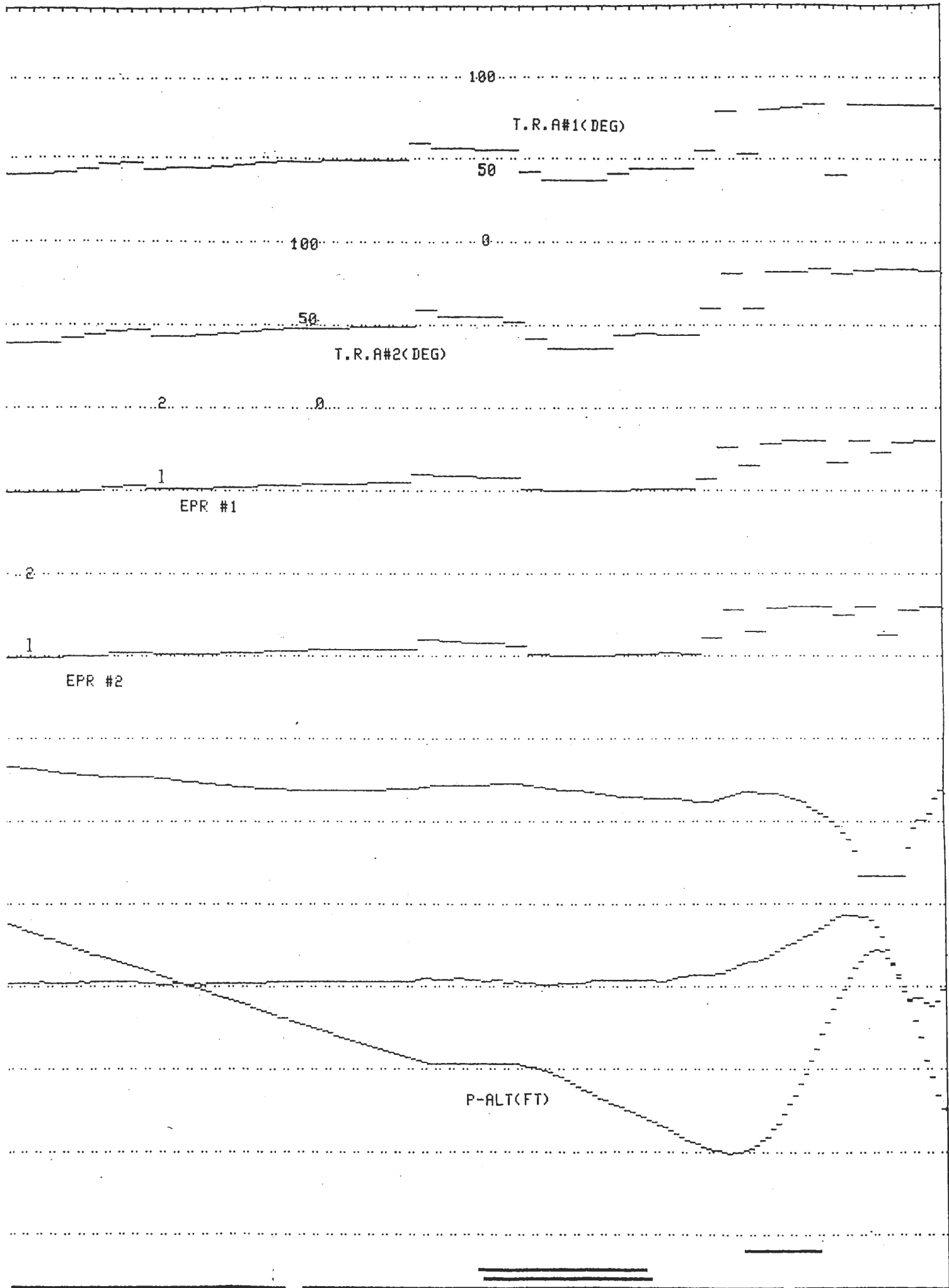

11:13

11:14

11:15

11:15' 43"

A107 ~ A108

TOTAL AIR TEMPERATURE (degree C.)

FUEL FLOW ENGINE1 (kg/h)

FUEL FLOW ENGINE2 (kg/h)

EXHAUST GAS TEMPERATURE ENGINE1 (degree C.)

EXHAUST GAS TEMPERATURE ENGINE2 (degree C.)

N2 ENGINE1 (%RPM)

N2 ENGINE2 (%RPM)

MIDDLE MARKER (line=receive)
OUTER MARKER (line=receive)
AUTO PILOT ENGAGE 2 COMMAND (line=on)
AUTO PILOT ENGAGE 1 COMMAND (line=on)
VHF-1 (non-line=transmit)

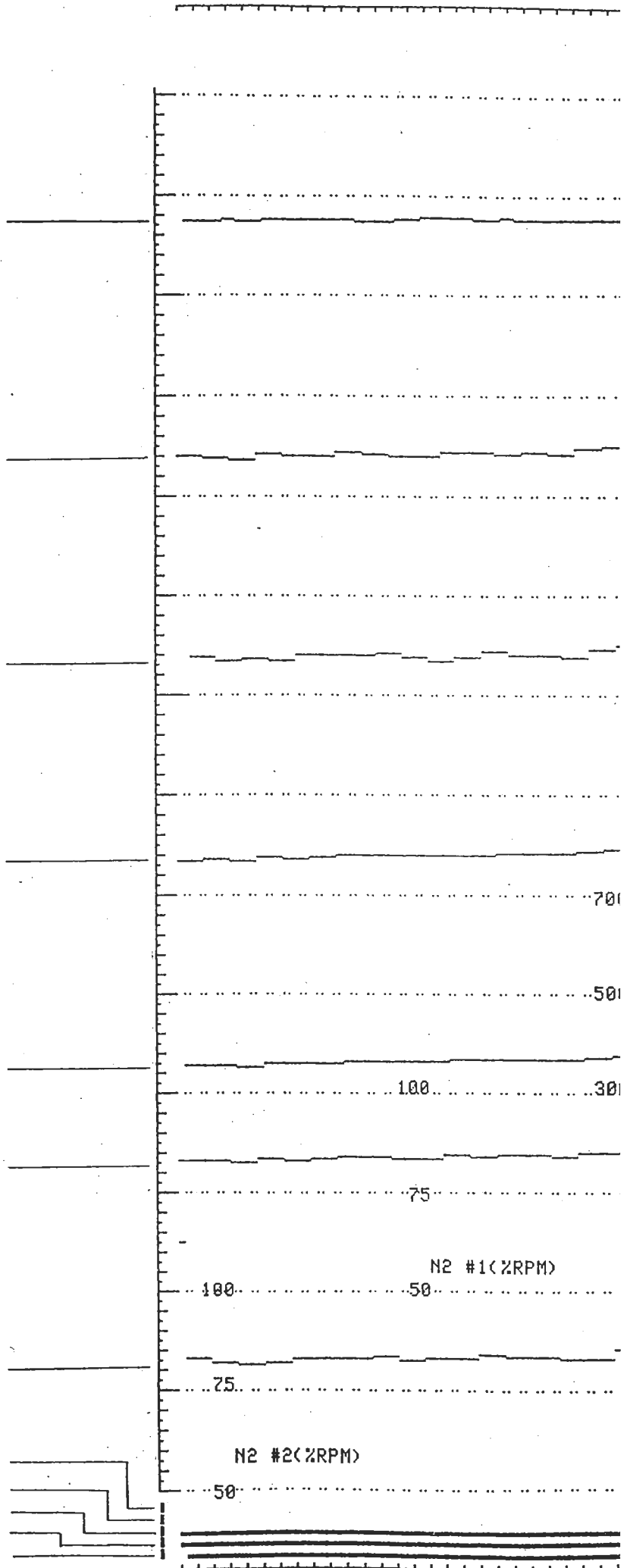

11:08(UTC)

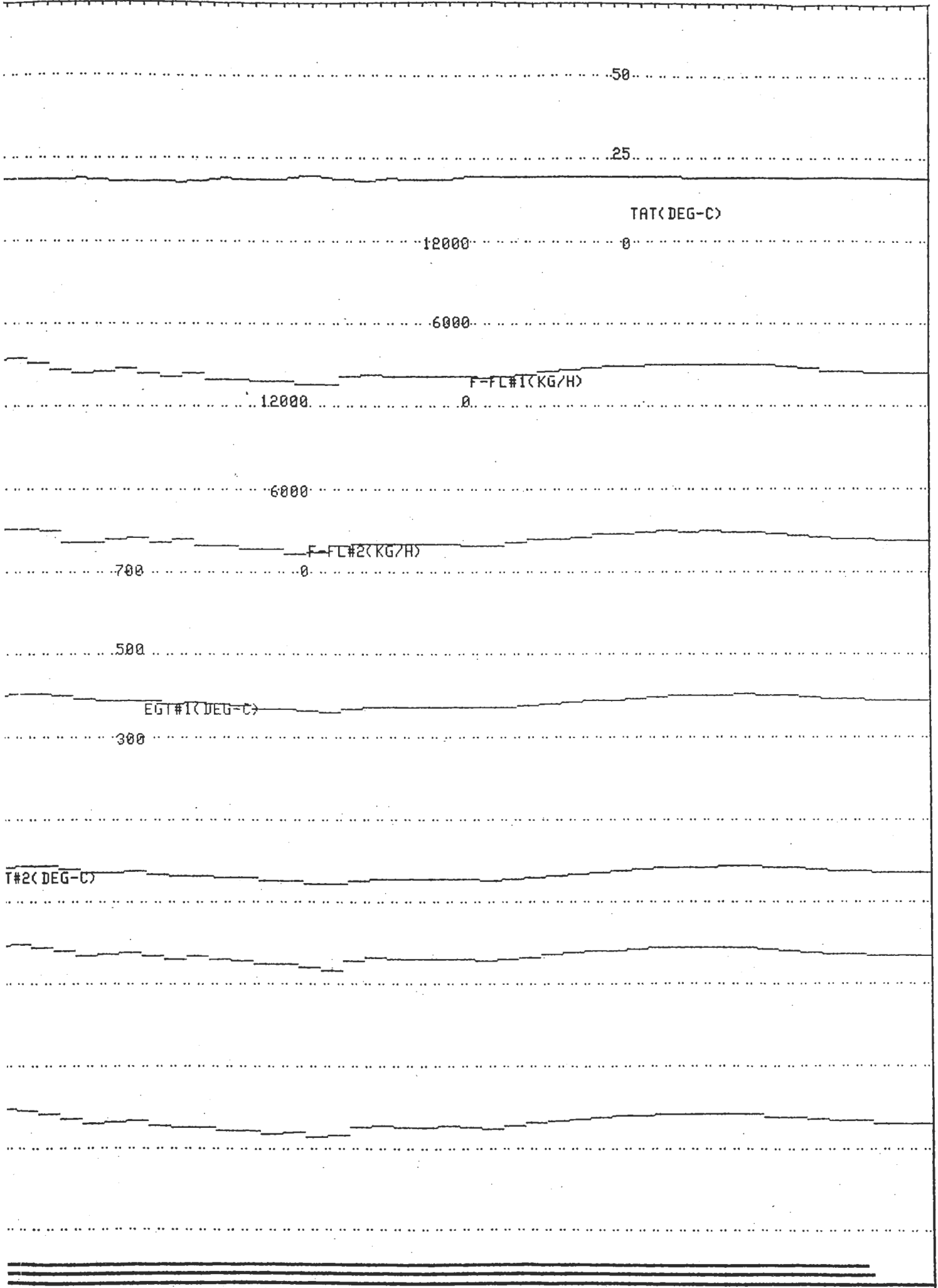

11:09

11:10

11:11

11:11'30"

A109 ~ A110

TOTAL AIR TEMPERATURE (degree C.)

FUEL FLOW ENGINE1 (kg/h)

FUEL FLOW ENGINE2 (kg/h)

EXHAUST GAS TEMPERATURE ENGINE1 (degree C.)

EXHAUST GAS TEMPERATURE ENGINE2 (degree C.)

N2 ENGINE1 (%RPM)

N2 ENGINE2 (%RPM)

MIDDLE MARKER (line=receive)
OUTER MARKER (line=receive)
AUTO PILOT ENGAGE 2 COMMAND (line=on)
AUTO PILOT ENGAGE 1 COMMAND (line=on)
VHF-1 (non-line=transmit)

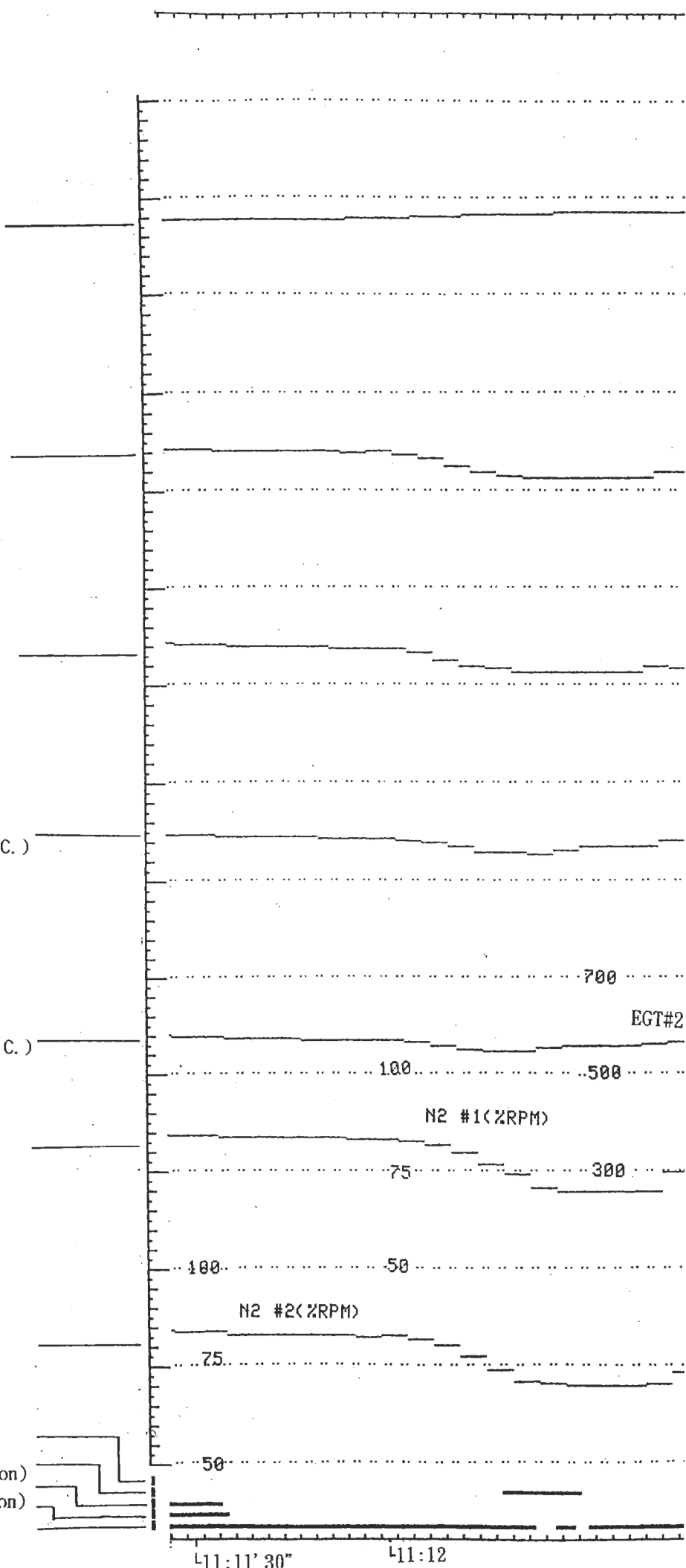

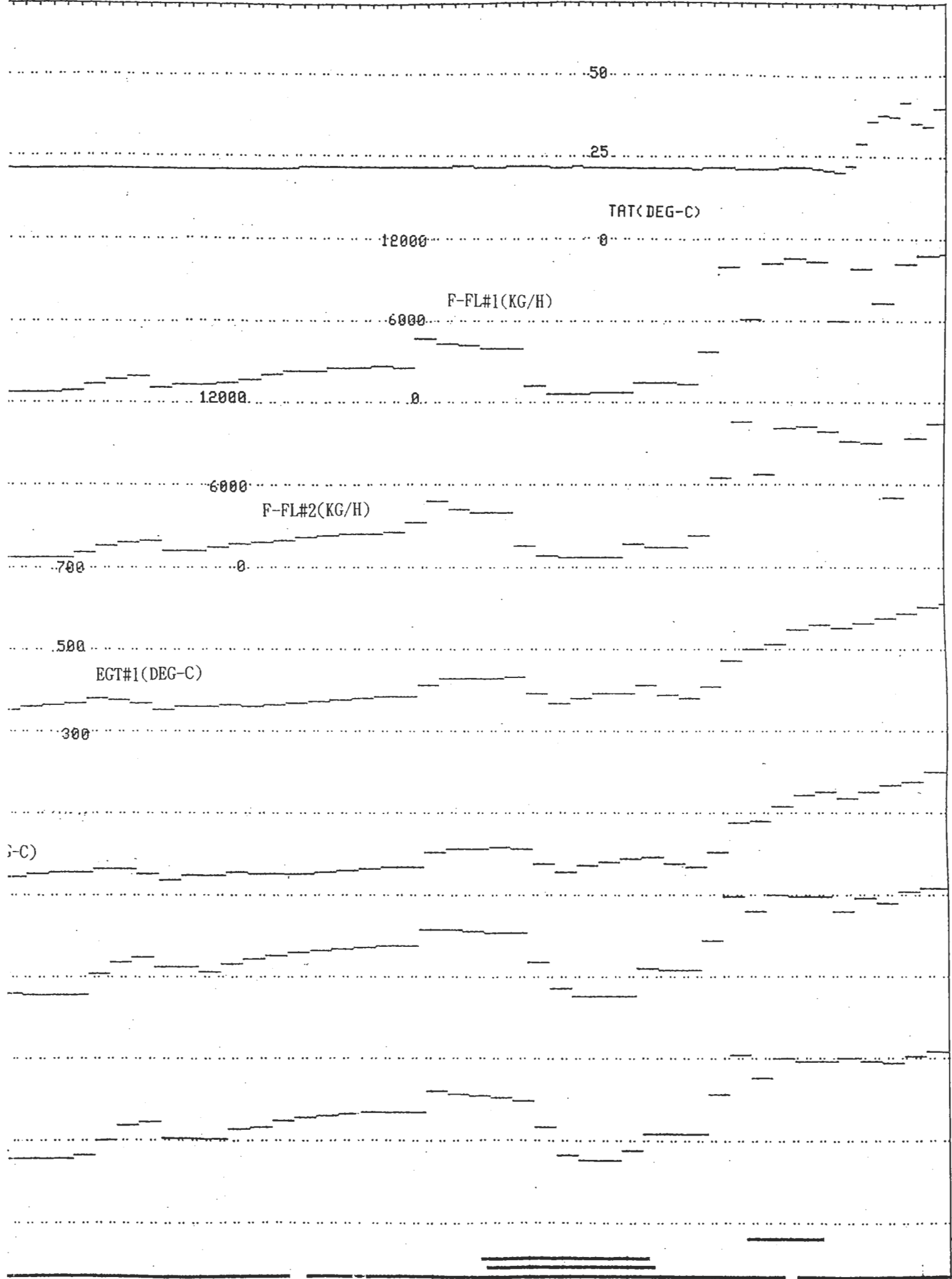

11:13

11:14

11:15

11:15'49"

A111 ~ A112

Appendix 7 CVR Records

C V R T R A N S C R I P T

- (1) This transcript was compiled based on the transcript made public at the hearing held in February 1995 and the results of the investigation after it.
- (2) The contents of communication between other aircraft and the air traffic control is not described here, and the contents of the announcements made in the cabin is briefly outlined.
- (3) The conversation and ATC communication were transcribed from CAP's and F/O's channels (channels 3 and 2; both channels recorded same content), the sounds in the cockpit were taken from the area microphone (channel 4), and the announcements by the cabin attendants were taken from channel 1.

DYNASTY 140	=CAL 140,	CAP	=CAPTAIN
F/O	=FIRST OFFICER,	C/A	=CABIN ATTENDANT
[]	=SOUND IN THE COCKPIT,	_____	=CAL 140'S COMMUNICATION WITH ATC
T-ACC	=TOKYO CONTROL,	APP	=NAGOYA APPROACH
TWR	=NAGOYA TOWER,	...	=UNABLE TO RECEIVE OR MEANING UNKNOWN

<u>UTC(hh:mm:ss")</u>	<u>Speaker</u>	<u>Content</u>
10:45'08"		(SOUND OF INTERPHONE CALL)
45'13"	CAP:	我們再3分鐘下降, 然後...20度...謝謝。
45'29"	CAP:	讓我們比比一下, 我們...比...現在用30跑道, 然後兩種動風...10 哩, 然後風向是...到...之間。 (ATC COMMUNICATION OF OTHER AIRCRAFT)
45'45"	F/O:	NAGOYA是...MSA...我們從那個什麼從東南方進去, 大概是在4800~ 5000呎左右...302的250, SET, SET, 然後...500呎三四洞的HEADING, 然後左轉兩三洞的RADIAL, 然後10哩以內。繼續跑到3000呎, 然 後左轉在10哩, 嗯, 10哩以內, 然後HOLD在那個么么洞RADIAL, 么么洞RADIAL上面。
46'31"	F/O:	MISSED APPROACH PROCEDURE, GO LEVER, GO AROUND POWER, FLAP ONE STEP, POSITIVE RATE, GEAR UP, HEADING SELECT, ALTIMETER 1500, LEVEL CHANGE, 250, LEVEL CHANGE, CRUISING POWER, THEN FOLLOW MISSED APPROACH PROCEDURE.
46'46"	F/O:	那我們算到, 算到跑道頭下降的話, 116哩下降。
46'52"	CAP:	OK.
46'59"	CAP:	要不要關, 燈要不要關?
47'02"	F/O:	好像蠻好。
47'08"	CAP:	調整一下。覺得怎麼樣?
	CAP:	這樣子好? 還是這樣子好?
47'13"	F/O:	還不錯, 教官。

47' 14" CAP: 這樣子啊?還是要再暗一點?
F/O: 再暗一點好了, 教官。
CAP: 再暗一點哦。

47' 17" F/O: 教官, 你是都開燈落地的嗎?
CAP: 啊?
F/O: 教官是開燈落地的嗎?
47' 21" CAP: 沒有, 沒有, 我是這樣子。
F/O: 噢。
CAP: 你呢?
F/O: 我沒有養成固定習慣。
CAP: 嗯?
F/O: 我都沒有養成固定習慣。
CAP: 噢。
F/O: 這樣, 這樣子感覺還不錯。
CAP: 你這樣子試試看這樣子看看?
F/O: 哦。
CAP: 馬上這個...。
(ATC COMMUNICATION OF OTHER AIRCRAFT)

47' 35" T-ACC: DYNASTY140, START DESCEND FOR FLIGHT LEVEL 210.
47' 40" CAP: DYNASTY140, NOW LEAVING 330 FOR 210.
47' 44" T-ACC: DYNASTY140, ROGER, CONTACT TOKYO CONTROL 125.7.
47' 48" CAP: 1257, DYNASTY140, GOOD NIGHT, SIR.
47' 52" T-ACC: GOOD NIGHT.
48' 06" CAP: GOOD EVENING, TOKYO CONTROL, DYNASTY140,
NOW PASSING 325 FOR FLIGHT LEVEL 210.
48' 13" T-ACC: DYNASTY140, TOKYO CONTROL, GOOD EVENING,
DESCEND AND MAINTAIN 9000, AREA QNH 2984.
48' 19" CAP: RECLEAR 9000, 2984, DYNASTY140.
(ATC COMMUNICATION OF OTHER AIRCRAFT)
[WHISTLING]

49' 14" CAP: WEATHER RADAR.
F/O: 是。
(ATC COMMUNICATION OF OTHER AIRCRAFT)

49' 22" F/O: 看到名古屋城了嘛, 教官。
(OVERLAP) CAP: 哇賽, 這天氣真好。(某某人)在多好。
F/O: 哈哈。
(ATC COMMUNICATION OF OTHER AIRCRAFT)
F/O: 耶, 報告教官。

CAP: 耶, 是。
 50' 42" F/O: 教官, 當我們在落地的時候, 教官在看那個地面跟飛機接近率的時候, 教官, 教官的方法是怎麼樣?
 (ATC COMMUNICATION OF OTHER AIRCRAFT)
 CAP: 晚上呵。
 F/O: 哎。
 51' 02" CAP: 晚上的時候五十呎的時候稍為帶一點點。
 F/O: 噢。
 CAP: 帶一點點, 把那個DESCENT RATE稍微減低一點, 因為人的精神啊, 跟這個地上接觸, 會, 會那個, 感覺都會遲鈍, 晚上。
 51' 13" F/O: 對。
 51' 14" CAP: 你把五十呎稍微帶一點點, THIRTY你再帶, TEN, TWENTY, TEN你就多帶一點, THIRTY, TWENTY你就慢慢帶, TEN, FIVE把它帶起來, 啪收完, 拉落地, 最標準是這樣。
 F/O: 噢。
 51' 21" C/A: (CABIN ANNOUNCEMENT IN CHINESE
 :準備降落的播音及請協助空勤人員收回耳機)
 CAP: 但是要看遠。
 F/O: 看遠。
 51' 31" C/A: (CABIN ANNOUNCEMENT IN ENGLISH
 : LANDING AND COLLECT HEADPHONE)
 CAP: 最重要就是要看遠。
 51' 34" F/O: 教, 教官您看遠的目的是爲了要看...?
 51' 36" CAP: 不是, 看遠的目的就是看飛機的沉, 比較容易看得清楚, 要看看前面, 飛機, 飛機...。
 (ATC COMMUNICATION OF OTHER AIRCRAFT)
 51' 45" C/A: (CABIN ANNOUNCEMENT IN JAPANESE
 : LANDING AND COLLECT HEADPHONE)
 CAP: IGS很重要。那天, (某某人) 飛得很好。
 F/O: IGS哦。
 CAP: 我兩次, 我都沒動手, 他自己落下去。他落的CAPTAIN他媽的也沒有比他飛得好。
 F/O: 啊呀。
 CAP: IGS看三么跑道頭, 你要注意看三么跑道頭, 這樣子躡進來, 先慢慢慢慢躡, 躡進來, 然後對跑道, 比較容易對得好, 你不要看他媽的么三跑道頭, 要看三么跑道頭。
 F/O: 噢。
 CAP: 這樣子去感覺, 這樣子去對感覺用裡面, 裡面只要看SPEED, 什

麼都不要看，一到MINIMUM以後，裡面都不要看。人家以前我們講，他媽的還是要講下降到幾度幾度，他媽的，…真的不要看。裡面就看速度，外面看那個，然後DESCENT RATE不要超過五百，慢慢這樣帶，轉到這邊以後，轉到這邊以後，四百到五百呎，對正跑道以後再看它，看它低啊高的，然後再推下去，還是KEEP著SPEED，然後落地。這樣就很好了。裡就是看飛機頭，什麼人家跟你講什麼都沒有用。

F/O: 噢。

CAP: 只要看SPEED，外面就是看跑道，這樣子比較簡化。

52' 56"

F/O: 嗯哼。

53' 09"

CAP: 我那天，讓讓(某某人)這樣飛，我說「你你照我的方法這樣飛」，飛得蠻好的，可以把它飛進來。

(ATC COMMUNICATION OF OTHER AIRCRAFT)

53' 39"

CAP: 他就是用AUTO THRUST。

F/O: 哦，用AUTO THROTTLE啊。

CAP: 如果，如果用MANUAL。

F/O: 哦。

53' 49"

CAP: 哼，就一百分了，只有九十分，就是因為用AUTO THRUST。

(ATC COMMUNICATION OF OTHER AIRCRAFT)

54' 05"

CAP: 到了五邊啊，一千呎，一千五都可以把他解掉。就這樣飛嘛，不要怕，就這樣飛，感覺上這個狀態跟這個油門的關係。

F/O: 關係。

CAP: 多練多飛就好了。

(ATC COMMUNICATION OF OTHER AIRCRAFT)

54' 44"

CAP: 飛行啊不要壓力大，你知道，不要患得患失，我落地要怎麼樣怎麼樣，平常心去落。

F/O: 噢。

CAP: 後面坐了人都不要怕，就是我飛我的，不要覺得很緊張，哇的。千萬不要，那天那個什麼香港那個什麼民航局來，我該叫什麼叫什麼，本來我是就是那個落地我沒有給他飛，其他，其他幾個落地都給他飛，沒辦法，那個民航局來了，我飛，照樣我說沒關係，誰來都一樣，要有這種胸襟，你知道誰坐上面都一樣。我就是這樣飛，很穩的這樣子四平八穩的飛，不要緊張。

(ATC COMMUNICATION OF OTHER AIRCRAFT)

55' 40"

CAP: 哼看就看，怎麼樣，我說不定還說他，你根本就不懂，看什麼。

F/O: 哼。

CAP: 不要怕。

(ATC COMMUNICATION OF OTHER AIRCRAFT)

CAP: ...就算, 就算...
 56' 07" CAP: 這個五邊的時候, 啊, 這個手儘量放鬆。
 56' 11" F/O: 放鬆一點。
 56' 12" CAP: 鬆啊, 就這樣, 輕輕的這樣放, 就這樣飛, 就這樣, 輕輕飛, 油
 門, 這樣。
 56' 22" F/O: 油門 兩九八四。
 (ATC COMMUNICATION OF OTHER AIRCRAFT)
 57' 36" CAP: TOKYO CONTROL, DYNASTY140, APPROACHING 9000.
 57' 43" T-ACC: DYNASTY140, STAND BY.
 (ATC COMMUNICATION OF OTHER AIRCRAFT))
 57' 59" T-ACC: DYNASTY140, CONTACT NAGOYA APPROACH 120.3.
 58' 02" CAP: 120.3, DYNASTY140, GOOD NIGHT, SIR.
 58' 05" T-ACC: GOOD NIGHT.
 (ATC COMMUNICATION OF OTHER AIRCRAFT)
 58' 18" CAP: GOOD EVENING, NAGOYA APPROACH, DYNASTY140,
 NOW PASSING 10600 FOR 9000, WITH INFORMATION
 BRAVO.
 58' 30" APP: DYNASTY140, DESCEND AND MAINTAIN 6000.
 58' 34" CAP: DESCEND 6000, DYNASTY140.
 58' 45" [WHISTLING]
 (ATC COMMUNICATION OF OTHER AIRCRAFT)
 59' 04" F/O: ... CHECKLIST.
 59' 05" CAP: YES.
 (ATC COMMUNICATION OF OTHER AIRCRAFT)
 59' 08" CAP: ECAM STATUS NORMAL, ALTIMETER 2984 AND MDA 302,
 DECISION HEIGHT 250.
 59' 17" F/O: SET.
 59' 18" CAP: OK.
 59' 20" CAP: V-BUGS, ...
 (ATC COMMUNICATION OF OTHER AIRCRAFT)
 (OVERLAP) CAP: SIGN ON, IGNITION CONTINUE RELIGHT, LANDING ELEVATION.
 59' 35" APP: DYNASTY140, REDUCE SPEED TO 210KNOTS OR LESS.
 59' 39" F/O: 200.
 59' 40" CAP: REDUCE 200KNOTS, DYANSTY140.
 59' 43" APP: ROGERED DYNASTY140, DESCEND AND MAINTAIN 5000.
 59' 47" CAP: CLEARED 5000, DYNASTY140.
 59' 51" CAP: LANDING ELEVATION 46, CABIN ALTITUDE 740, APPROACH
 BRIEFING.

11:00' 00" (ATC COMMUNICATION OF OTHER AIRCRAFT)
 F/O: COMPLETE, SIR.
 (ATC COMMUNICATION OF OTHER AIRCRAFT)
 00' 02" CAP: SHOULDER HARNESSSES.
 F/O: FASTEN RIGHT.
 00' 05" CAP: OK, FASTEN LEFT, APPROACH CHECKLIST COMPLETED.
 (ATC COMMUNICATION OF OTHER AIRCRAFT)
 00' 11" CAP: 你自己做。
 F/O: 是。
 CAP: 我不BOTHER 你了,你不要問我, 自己做, 做DECISION。除非到了
 我不能COVER的時候, 我才會提醒你。
 (ATC COMMUNICATION OF OTHER AIRCRAFT)
 00' 28" F/O: 是。
 00' 29" CAP: 自己做, 啊。
 00' 30" F/O: YES, SIR.
 (ATC COMMUNICATION OF OTHER AIRCRAFT)
 01' 26" APP: DYNASTY140, FLY HEADING 050.
 01' 31" CAP: HEADING 050, DYNASTY140.
 (ATC COMMUNICATION OF OTHER AIRCRAFT)
 01' 58" APP: DYNASTY140, REDUCE SPEED 180KNOTS.
 02' 02" CAP: REDUCING 180KNOTS, DYNASTY140.
 02' 07" F/O: FLAP SET, SIR.
 (ATC COMMUNICATION OF OTHER AIRCRAFT)
 02' 27" C/A: (CABIN ANNOUNCEMENT IN CHINESE
 :名古屋到着的時間及天氣)
 03' 06" C/A: (CABIN ANNOUNCEMENT IN ENGLISH
 : ARRIVAL TIME AND WEATHER INFORMATION AT NAGOYA)
 03' 27" CAP: NAGOYA APPROACH, DYNASTY140, APPROACHING 5000.
 03' 31" APP: DYNASTY140, ROGER, MAINTAIN 5000.
 03' 34" CAP: DYNASTY140.
 03' 43" [WHISTLING]
 03' 57" C/A: (CABIN ANNOUNCEMENT IN JAPANESE
 : ARRIVAL TIME AND WEATHER INFORMATION AT NAGOYA)
 04' 03" APP: DYNASTY140, TURN LEFT HEADING 010.
 04' 06" CAP: LEFT HEADING 010, DYNASTY140.
 (ATC COMMUNICATION OF OTHER AIRCRAFT)
 04' 46" C/A: (CABIN ANNOUNCEMENT IN TAIWANESE:...)
 04' 50" CAP: 哇賽。

04' 59" APP: DYNASTY140, DESCEND AND MAINTAIN 4000.

05' 03" CAP: DESCEND AND MAINTAIN 4000, DYNASTY140.
(ATC COMMUNICATION OF OTHER AIRCRAFT)

05' 27" APP: DYNASTY, SAY AGAIN AIR SPEED?

05' 31" CAP: DYNASTY140, SPEED 180.

05' 34" APP: THANK YOU.

05' 37" APP: DYNASTY140, NOW DESECEND AND MAINTAIN 2500.

05' 40" CAP: CLEARED TO 2500, DYNASTY140.
(ATC COMMUNICATION OF OTHER AIRCRAFT)

07' 14" APP: DYNASTY140, YOU ARE NOW 14 MILES FROM THE OUTER MARKER
AND CLEARED FOR ILS RUNWAY34 APPROACH CONTACT TOWER
118.7.

07' 21" CAP: CLEARED ILS RUNWAY34 APPROACH, 118.7,
DYNASTY140, GOOD NIGHT, SIR.

07' 37" CAP: GOOD EVENING, NAGOYA TOWER, DYNASTY140, RUNWAY34
APPROACH.

07' 42" TWR: DYNASTY140, NAGOYA TOWER, GOOD EVENING,
REPOT OUTER MARKER, RUNWAY34.

07' 47" CAP: REPORT OUTER MARKER, DYNASTY140.

F/O: 哇賽。

08' 26" F/O: 它這邊好像常常會吃到, 直接吃到人家的尾流。

08' 29" CAP: 對。

08' 30" F/O: 奇怪它是, 地型的關係? 今天尾流好像, 好像從頭吃到尾。

08' 35" CAP: 把舵蹬緊, 舵蹬緊就好了, 抖得不會那麼厲害。

08' 41" CAP: OK, LOCALIZER ALIVE.

08' 43" F/O: YES, SIR.

08' 47" CAP: LOC STAR.

08' 48" F/O: YES, SIR.

CAP: RUNWAY HEADING INBOUND COURSE.

F/O: YES, SIR.

08' 55" CAP: ... 前面那一架, 哇賽。你再把它, 把它SPEED再KILL一點好了。

08' 59" F/O: 教官, 是不是747的?

09' 00" CAP: 不曉得。

09' 01" CAP: 你再把SPEED再KILL一點好了, KILL到, 到么拐洞好了。

F/O: 么拐洞。

CAP: 噯, 要不然的話他媽的在後面他媽的接著他那個下去會昏倒。

CAP: 在低空改, 變化要稍微小一點, 不要太大的改, 一點點改, 噢,

儘量柔和一點點改，因為晚上有時候會，下意識的錯覺。
(ATC COMMUNICATION OF OTHER AIRCRAFT)

09' 50" F/O: WINDSHEAR.

10' 01" CAP: 沒關係。那個…
(ATC COMMUNICATION OF OTHER AIRCRAFT)

10' 50" CAP: 你等一下全，全全神，WATCH這個。
[SOUND OF SEAT ADJUSTER]

10' 53" F/O: 是，教官。

10' 54" CAP: 不要看別的，看到這裡，噯，從頭到尾看到這裏，看到MINIMUM，
再看外面。
(ATC COMMUNICATION OF OTHER AIRCRAFT)

F/O: 吃到了，教官。

CAP: 對啊。

11' 20" F/O: 吃到了，吃到了，它從GLIDE SLOPE就開始吃。

11' 24" CAP: 太多架飛機了沒有辦法。

11' 26" F/O: 看來這個，這個就是干攪了啊？

11' 28" CAP: 沒關係，因為…

11' 34" F/O: 教官，那我把他解掉好了。

11' 35" CAP: 好。你用手飛。
[SOUND OF AUTO PILOT SW]

11' 36" [SOUND OF AUTO PILOT DISENGAGE]
(ATC COMMUNICATION OF OTHER AIRCRAFT)

11' 40" [SOUND OF AUTO PILOT DISENGAGE]
(ATC COMMUNICATION OF OTHER AIRCRAFT)

11' 45" CAP: GLIDE SLOPE ALIVE.

11' 46" F/O: YES, SIR. RUNWAY GO AROUND ALTITUDE 三千呎。

11' 49" CAP: OK.

11' 54" CAP: OH.

11' 55" [SOUND OF ALTITUDE ALERT]

11' 57" F/O: 哦，教官，它這個GLIDE SLOPE STAR.
CAP: GS STAR.
F/O: GS STAR.

12' 01" CAP: 噯，沒問題了。
[SOUND OF PITCH TRIM CONTROL SW](3 TIMES)

12' 19" CAP: OUTER MARKER. (SOUND NOTHING)
F/O: YES, SIR.

12' 23" CAP: NAGOYA TOWER, DYNASTY140, OUTER MARKER.
[SOUND OF PITCH TRIM CONTROL SW](1 TIME)

12' 26" TWR: DYNASTY140, CONTINUE APPROACH, NUMBER ONE
TOUCH DOWN.

12' 30" CAP: CONTINUE, DYNASTY140.
[SOUND OF PITCH TRIM CONTROL SW](2 TIMES)

12' 41" F/O: FLAP 20.

12' 42" CAP: OK, FLAP 20.
[SOUND OF SLATS/FLAPS LEVER OPERATION](2 TIMES,
15/15 TO 15/20)

12' 44" F/O: SPEED 150, PLEASE.
(ATC COMMUNICATION OF OTHER AIRCRAFT)
[SOUND OF PITCH TRIM CONTROL SW](1 TIME)

12' 54" CAP: 20 SET.

12' 56" F/O: GEAR DOWN.
[SOUND OF GEAR DOWN]

13' 01" C/A: (CABIN ANNOUNCEMENT IN CHINESE
:請不要吸煙)

13' 10" C/A: (CABIN ANNOUNCEMENT IN ENGLISH
: NO SMOKING)
(ATC COMMUNICATION OF OTHER AIRCRAFT)
[SOUND OF PITCH TRIM CONTROL SW](5 TIMES)
(ATC COMMUNICATION OF OTHER AIRCRAFT)

13' 13" CAP: GEAR DOWN, THREE GREEN.
(ATC COMMUNICATION OF OTHER AIRCRAFT)

13' 14" F/O: 30/40, SPEED V APPROACH 140, LANDING CHECK LIST, PLEASE.
[SOUND OF SLATS/FLAPS LEVER OPERATION](2 TIMES;
15/20 TO 30/40)
(ATC COMMUNICATION OF OTHER AIRCRAFT)

13' 21" CAP: LANDING GEAR DOWN, THREE GREEN, ANTI-SKID NORMAL, SLATS/
FLAPS 30/40, SPOILERS ARMED, LANDING LIGHTS ON.
[SOUND OF PITCH TRIM CONTROL SW](5 TIMES)

13' 25" C/A: (CABIN ANNOUNCEMENT IN JAPANESE
: NO SMOKING)

13' 27" CAP: LANDING CHECK LIST COMPLETED.

13' 29" F/O: THANK YOU.
(ATC COMMUNICATION OF OTHER AIRCRAFT)

13' 39" TWR: DYNASTY140, CLEARED TO LAND RUNWAY34, WIND 290 AT 6.

13' 43" CAP: CLEARED TO LAND RUNWAY34, DYNASTY140.

13' 47" CAP: 兩玖洞, 陸湮。

C/A: (CABIN ANNOUNCEMENT IN TAIWANESE:...)

13' 48" F/O: 是啊。

13' 49" CAP: 有點左側風。

13' 57" CAP: ALL LIGHTS ON.

14' 06" CAP: 哎，哎，啊。

14' 09" [CLICK CLICK CLICK] (SOUND OF LANDING CAPABILITY
CHANGE WARNING)

14' 10" CAP: 你搵，你搵到那個GO LEVER了。

14' 11" F/O: 對，對，對。觸到一點點。

14' 12" CAP: 把它解掉。
F/O: 誒。

14' 16" CAP: 那個。
F/O: 誒。

14' 20" CAP: 你望，看到外面，外面哦。
[SOUND OF PITCH TRIM CONTROL SW](1 TIME)

14' 23" CAP: 推下去，把它推下去，哎。

14' 26" CAP: 你把那個…油門解掉。

14' 29" F/O: 哎，太高了

14' 30" CAP: 你，你用GO AROUND MODE。

14' 34" CAP: 沒關係，慢慢再解，再扶到手上。
[SOUND OF PITCH TRIM CONTROL SW](3 TIMES)

14' 39" CAP: ENGINE THRUST解掉囉？
[SOUND OF PITCH TRIM CONTROL SW](2 TIMES)

14' 40" F/O: 是的，教官，解掉了。

14' 41" CAP: 再推，再推，再推。
F/O: 是。

14' 43" CAP: 再推下去。

14' 45" CAP: 它現在在GO AROUND MODE。
F/O: 是的，教官…。
(ATC COMMUNICATION OF OTHER AIRCRAFT)

14' 49" F/O: 教官，AUTO PILOT DISENGAGE了。
(OVERLAP) [SOUND OF AUTO PILOT SW]

14' 50" [SOUND OF AUTO PILOT DISENGAGE]
(ATC COMMUNICATION OF OTHER AIRCRAFT)

14' 51" F/O: 教官還是推不下去，哎。

14' 58" CAP: 我剛那個LAND MODE了嗎？

15' 01" CAP: 沒關係，慢慢來。

15' 02" F/O: 教官，THROTTLE又LATCH了。

15' 03" CAP: OK 我來，我來，我來。

15' 04" F/O: 解掉，解掉。

15' 08" CAP: 這怎麼搞的？

15' 09" F/O: 解掉。解…。

15' 11" CAP: GO LEVER.
CAP: 他媽的，怎麼會這樣子？
[SOUND OF PITCH TRIM CONTROL SW](2 TIMES)

15' 14" F/O: NAGOYA TOWER, DYNASTY GOING AROUND.

15' 17" [GLIDE SLOPE](SOUND OF GPWS WARNING)

15' 18" CAP: 哎？

(OVERLAP) TWR: ROGER, STAND BY, FURTHER INSTRUCTION.
[SOUND OF SLATS/FLAPS LEVER OPERATION](2~3 TIMES,
30/40 TO 15/0 OR 0/0)

15' 21" CAP: 哎，它這樣會失速耶。

15' 23" [SINGLE CHIME](SOUND OF MASTER CAUTION)

15' 25" CAP: 完了。
[SOUND OF STALL WARNING](2 SECONDS)

(OVERLAP) 15' 26" F/O 快，推機頭。
[SOUND OF SLATS/FLAPS LEVER OPERATION](1 TIME,
15/0 OR 0/0 TO 15/15)

15' 28" [SINGLE CHIME](SOUND OF MASTER CAUTION)
(ATC COMMUNICATION OF OTHER AIRCRAFT)

15' 31" [SINGLE CHIME](SOUND OF MASTER CAUTION)

(OVERLAP) F/O: SET, SET, 推機頭。

15' 34" CAP: 沒關係，沒關係。
不，不要，不要急，不要急。
F/O: POWER.

15' 37" [TERRAIN TERRAIN](SOUND OF GPWS WARNING)
CAP: 啊，哇。
F/O: POWER, POWER. POWER.

15' 40" [SOUND OF STALL WARNING](CONTINUED TILL THE END OF
RECORD)

CAP: 哇，啊。
F/O: POWER.
CAP: 完了。
F/O: POWER.
CAP: 啊。
F/O: POWER. POWER.

15' 45" END OF RECORDING (NO CRASH SOUND RECORDED)

CVR TRANSCRIPT

(TRANSLATED INTO ENGLISH FROM CVR RECORD)

- (1) This transcript was compiled based on the transcript made public at the hearing held in February 1995 and the results of the investigation after it.
- (2) The contents of communication between other aircraft and the air traffic control is not described here, and the contents of the announcements made in the cabin is briefly outlined.
- (3) The conversation and ATC communication were transcribed from CAP's and F/O's channels (channels 3 and 2; both channels recorded same content), the sounds in the cockpit were taken from the area microphone (channel 4), and the announcements by the cabin attendants were taken from channel 1.
- (4) The original transcript of CVR is composed of ATC communication in English and the conversation in the cockpit in Chinese. This transcription translates the part of Chinese into English which shows wave underline.

DYNASTY 140	= CAL 140,	CAP	= CAPTAIN
F/O	= FIRST OFFICER,	C/A	= CABIN ATTENDANT
[]	= SOUND IN THE COCKPIT,	_____	= CAL 140'S COMMUNICATION WITH ATC
T-ACC	= TOKYO CONTROL,	APP	= NAGOYA APPROACH
TWR	= NAGOYA TOWER,	...	= UNABLE TO RECEIVE OR MEANING UNKNOWN

UTC(hh:mm:ss") Speaker Content

10:45'08" (SOUND OF INTERPHONE CALL)

45'13" CAP: DESCEND IN 3 MINUTES. THEN...20 DEGREES...THANKS.

45'29" CAP: LET'S COMPARE. WE...COMPARE...NOW, USE RUNWAY 30,
THEN 2 KINDS OF WINDS...10 KNOTS, AND DIRECTION...
BETWEEN...AND...

 (ATC COMMUNICATION OF OTHER AIRCRAFT)

45'45" F/O: NAGOYA..., MSA...WE ARE AH APPROACHING FROM SOUTH EAST,
PROBABLY AT 4800 TO 5000 FEET, ...250 OF 302, SET, SET,
THEN...500 FEET, HEADING 340, AFTER THAT, TURN LEFT TO
230 RADIAL, WITHIN 10 MILES, THEN CONTINUE TO 3000 FEET,
THEN TURN LEFT 10 MILES, UH, WITHIN 10 MILES, HOLD ON
110 RADIAL, ON 110 RADIAL.

46' 31" F/O: MISSED APPROACH PROCEDURE, GO LEVER, GO AROUND POWER, FLAP ONE STEP, POSITIVE RATE, GEAR UP, HEADING SELECT, ALTIMETER 1500, LEVEL CHANGE, 250, LEVEL CHANGE, CRUISING POWER, THEN FOLLOW MISSED APPROACH PROCEDURE.

46' 46" F/O: SO WE CALCULATE, IF WE CALCULATE ASSUMING WE LAND ON THE RUNWAY END, START DESCENT AT 116 MILES.

46' 52" CAP: OK.

46' 59" CAP: TURN OFF? PREFER THE LIGHTS TURNED OFF?

47' 02" F/O: DOESN'T LOOK BAD.

47' 08" CAP: ADJUST A LITTLE BIT. HOW ABOUT IT?

CAP: IS THIS BETTER? OR THIS?

47' 13" F/O: NOT BAD, SIR.

47' 14" CAP: HOW ABOUT THIS? OR DIMMER?

F/O: SLIGHTLY DIMMER IS BETTER, SIR.

CAP: YOU LIKE IT SLIGHTLY DIMMER.

47' 17" F/O: SIR, YOU LAND WITH LIGHTS ON?

CAP: AH?

F/O: YOU LAND WITH LIGHTS ON?

47' 21" CAP: NO, NO. I DO THIS WAY.

F/O: UH.

CAP: HOW ABOUT YOU?

F/O: I DON'T HAVE ANY FIXED WAY.

CAP: EH?

F/O: I DON'T HAVE ANY FIXED WAY YET.

CAP: AH.

F/O: THIS WAY, THIS WAY FEELS ALRIGHT.

CAP: YOU TRY THIS WAY, THIS WAY AND SEE?

F/O: AH.

CAP: RIGHT AWAY THIS ...

(ATC COMMUNICATION OF OTHER AIRCRAFT)

47' 35" T-ACC: DYNASTY 140, START DESCEND FOR FLIGHT LEVEL 210.

47' 40" CAP: DYNASTY 140, NOW LEAVING 330 FOR 210.

47' 44" T-ACC: DYNASTY 140, ROGER, CONTACT TOKYO CONTROL 125.7.

47' 48" CAP: 1257, DYNASTY 140, GOOD NIGHT, SIR.

47' 52" T-ACC: GOOD NIGHT.

48' 06" CAP: GOOD EVENING, TOKYO CONTROL, DYNASTY 140, NOW PASSING

325 FOR FLIGHT LEVEL 210.

48' 13" T-ACC: DYNASTY 140, TOKYO CONTROL, GOOD EVENING, DESCEND AND
 MAINTAIN 9000, AREA QNH 2984.

48' 19" CAP: RECLEAR 9000, 2984, DYNASTY 140.
 (ATC COMMUNICATION OF OTHER AIRCRAFT)
 [WHISTLING]

49' 14" CAP: WEATHER RADAR.
 F/O: YES.
 (ATC COMMUNICATION OF OTHER AIRCRAFT)

49' 22" F/O: NAGOYA CITY IN SIGHT, SIR.
 (OVERLAP) CAP: WOW! THE WEATHER IS EXCELLENT.
 HOW NICE IF (NAME OF PERSON) WERE HERE.
 F/O: HA, HA.
 (ATC COMMUNICATION OF OTHER AIRCRAFT)

F/O: SAY, SIR.
 CAP: YEAH, YES.

50' 42" F/O: SIR, WHEN WE LAND, HOW DO YOU DEAL WITH CLOSURE RATE
 AS YOU APPROACHING GROUND?
 HOW IS YOUR WAY, SIR?
 (ATC COMMUNICATION OF OTHER AIRCRAFT)

CAP: AT NIGHT.
 F/O: OH.

51' 02" CAP: AT NIGHT, ON REACHING 50 FEET, PULL A LITTLE.
 F/O: OH.
 CAP: PULL A LITTLE, REDUCE THE DESCENT RATE A LITTLE,
 BECAUSE THE MIND OF A PERSON, WHEN CONTACT WITH
 THE GROUND, WILL THAT, ... A PERSON DEPTH PERCEPTION
 IS NOT AS KEEN AT NIGHT.

51' 13" F/O: RIGHT.

51' 14" CAP: PULL A LITTLE AT 50 FEET, PULL MORE AT 30 FEET, 10, 20,
 PULL MORE AT 10. AT 30, 20 PULL SLOWLY, AT 10, 5 PULL
 IT, PULL POSITIVELY AND COMMENCE LANDING POSITIVELY,
 THIS IS THE MOST STANDARD WAY.
 F/O: OH.

51' 21" C/A: (CABIN ANNOUNCEMENT IN CHINESE:
 LANDING AND COLLECT HEADPHONE)

CAP: BUT, NEED TO LOOK AFAR.
 F/O: LOOK AFAR, RIGHT?
 51' 31" C/A: (CABIN ANNOUNCEMENT ON ARRIVAL AND RETRIEVAL OF
 HEADPHONE IN ENGLISH)
 CAP: THE MOST IMPORTANT THING IS TO LOOK AFAR.
 51' 34" F/O: SIR, THE PURPOSE OF LOOKING AFAR IS TO SEE...?
 51' 36" CAP: NO, THE PURPOSE OF LOOKING AFAR IS TO WATCH THE SINKING
 OF AIRCRAFT EASIER TO HAVE A CLEAR VIEW.
 WATCH AHEAD, WATCH, AIRCRAFT, AIRCRAFT...
 (ATC COMMUNICATION OF OTHER AIRCRAFT)
 51' 45" C/A: (CABIN ANNOUNCEMENT IN JAPANESE:
 LANDING AND COLLECT HEADPHONE)
 CAP: IGS IS VERY IMPORTANT.
 THE OTHER DAY, (NAME OF PERSON) FLEW VERY WELL.
 F/O: IGS, OH.
 CAP: I DIDN'T TAKE OVER ON BOTH CASES, HE LANDED BY HIMSELF.
 HE LANDED SO WELL, EVEN CAPTAIN CAN NOT DO BETTER.
 F/O: IS THAT SO?
 CAP: IGS, LOOK AT THE THRESHOLD OF RUNWAY 31, YOU HAVE TO PAY
 ATTENTION TO WATCH THRESHOLD OF RUNWAY 31 CAREFULLY.
 NUDGE IN, NUDGE IN SLOWLY, SLOWLY, THEN ALIGN WITH
 THE RUNWAY, IT IS EASIER TO ALIGN IT RIGHT.
 DO NOT WATCH THE RUNWAY 13 THRESHOLD.
 JUST LOOK AT RUNWAY 31 THRESHOLD.
 F/O: OH.
 CAP: WITH SUCH FEELING, ALIGN WITH SUCH FEELING, INSIDE,
 INSIDE JUST LOOK AT THE SPEED, NOTHING ELSE.
 AFTER REACHING MINIMUM, NO NEED TO LOOK INSIDE.
 IN THE OLD DAYS, DURING DESCENT, WE USED TO CALL SO AND
 SO DEGREES... YOU DON'T HAVE TO LOOK AT ANYTHING.
 INSIDE JUST WATCH THE SPEED, OUT-SIDE JUST LOOK AT IT,
 THEN DESCENT RATE SHOULD NOT EXCEED 500, SLOWLY PULL
 LIKE THIS, AFTER TURNING UP TO THIS POINT, TURNING UP
 TO THIS POINT, 400 TO 500 FEET, ALIGN WITH THE RUNWAY
 THEN LOOK AT IT. SEE WHETHER IT IS HIGH OR LOW.
 THEN, PUSH IT DOWN. THEN, KEEP THE SPEED AND LAND

BY THIS WAY, THINGS GO WELL.
 ~~~~~  
 INSIDE, JUST WATCH THE NOSE OF AIRCRAFT.  
 ~~~~~  
 DON'T MIND WHATEVER OTHERS TELL YOU.
 ~~~~~

52' 56" F/O: I SEE.  
 ~~~~~

53' 09" CAP: JUST WATCH THE SPEED, OUTSIDE, WATCH THE RUNWAY AT
 ~~~~~  
 ANY RATE. THIS IS SIMPLE, ISN'T IT?  
 ~~~~~

F/O: YES.
 ~~~~~

53' 39" CAP: THE OTHER DAY, I LET (NAME OF PERSON) FLY THIS WAY.  
 ~~~~~  
 I TOLD HIM "IF YOU FLY MY WAY, YOU CAN FLY WELL".
 ~~~~~  
 HE FLEW WELL. YOU CAN FLY WITH IT.  
 ~~~~~  
 (ATC COMMUNICATION OF OTHER AIRCRAFT)

F/O: HUH. HE USED AUTO THROTTLE?
 ~~~~~

CAP: IF, IF HE USED MANUAL.  
 ~~~~~

53' 49" F/O: HUH.
 ~~~~~

CAP: THEN IT'S 100 POINTS. BUT HE ONLY GOT 90 POINTS,  
 ~~~~~  
 BECAUSE HE USED AUTO THRUST.
 ~~~~~  
 (ATC COMMUNICATION OF OTHER AIRCRAFT)

54' 05" CAP: ON FINAL, AT 1000 FEET OR 1500 FEET, YOU MAY DISCONNECT  
 ~~~~~  
 IT. FLY THIS WAY, DON'T WORRY, FLY LIKE THIS.
 ~~~~~  
 FLY FEELING THE RELATIONSHIP BETWEEN THIS CONDITION AND  
 ~~~~~  
 THIS THROTTLE.
 ~~~~~

F/O: RELATIONSHIP, I SEE.  
 ~~~~~

54' 44" CAP: THE MORE YOU FLY AND PRACTICE, THE BETTER YOU CAN FLY.
 ~~~~~  
 (ATC COMMUNICATION OF OTHER AIRCRAFT)

CAP: IN FLYING, DON'T GIVE TOO MUCH PRESSURE.  
 ~~~~~  
 AS YOU KNOW, DON'T WORRY ABOUT GAINS AND LOSSES.
 ~~~~~  
 WHEN I LAND, I LAND WITH NORMAL MANNER NOT WORRYING  
 ~~~~~  
 ABOUT THIS OR THAT.
 ~~~~~

F/O: YES.  
 ~~~~~

CAP: DON'T WORRY ABOUT SOMEONE SITTING BEHIND, I JUST FLY
 ~~~~~  
 MY OWN WAY IN ANY CASE.  
 ~~~~~  
 DON'T GET NERVOUS, NEVER.
 ~~~~~  
 THE OTHER DAY, WELL, SOMEONE OF HONG KONG CIVIL AVIATION  
 ~~~~~  
 DEPARTMENT CAME, BUT I WILL SAY WHAT I HAVE TO SAY.
 ~~~~~  
 ACTUALLY, I DIDN'T LET HIM DO THAT LANDING.  
 ~~~~~

ON OTHERS, ON OTHER SEVERAL CASES, I LET HIM
DO LANDINGS. NO OTHER WAY.

IF THAT CAA MAN COMES, I FLY, NO PROBLEM. WHOEVER COMES,
I DO THE SAME. HAVE SUCH A FRAME OF MIND, UNDERSTAND?

AS YOU KNOW, WHOEVER COMES ON BOARD, THE SAME THING.

ANYWAY, FLY THIS WAY, FLY STEADILY AS FLAT AND AS STEADY
LIKE THIS, DON'T BE NERVOUS.

(ATC COMMUNICATION OF OTHER AIRCRAFT)

55' 40" CAP: IF HE WANTS TO WATCH, THEN LET HIM DO SO. SO WHAT.
MAYBE I TELL HIM, "WHAT ARE YOU SEEING, NOT KNOWING
WHAT TO SEE?"

F/O: HUM.

CAP: DON'T WORRY.

(ATC COMMUNICATION OF OTHER AIRCRAFT)

CAP: ...EVEN IF, EVEN IF...

56' 07" CAP: IN THE FINAL LEG, AH, RELAX YOUR HANDS AS MUCH AS
POSSIBLE.

56' 11" F/O: RELAX A LITTLE.

56' 12" CAP: RELAX, LIKE THIS, PUT THEM DOWN GENTLY LIKE THIS,
JUST FLY LIKE THIS, JUST LIKE THIS, FLY GENTLY,
THROTTLE LIKE THIS.

56' 22" F/O: THROTTLE, 2984.

(ATC COMMUNICATION OF OTHER AIRCRAFT)

57' 36" CAP: TOKYO CONTROL, DYNASTY 140 APPROACHING 9000.

57' 43" T-ACC: DYNASTY 140, STAND BY.

(ATC COMMUNICATION OF OTHER AIRCRAFT)

57' 59" T-ACC: DYNASTY 140, CONTACT NAGOYA APPROACH 120.3.

58' 02" CAP: 120.3, DYNASTY 140 GOOD NIGHT, SIR.

58' 05" T-ACC: GOOD NIGHT.

(ATC COMMUNICATION OF OTHER AIRCRAFT)

58' 18" CAP: GOOD EVENING, NAGOYA APPROACH, DYNASTY 140, NOW PASSING
10600 FOR 9000, WITH INFORMATION BRAVO.

58' 30" APP: DYNASTY 140, DESCEND AND MAINTAIN 6000.

58' 34" CAP: DESCEND 6000, DYNASTY 140.

58' 45" [WHISTLING]

(ATC COMMUNICATION OF OTHER AIRCRAFT)

59' 04" F/O: ... CHECKLIST.

59' 05" CAP: YES.
(ATC COMMUNICATION OF OTHER AIRCRAFT)

59' 08" CAP: ECAM STATUS NORMAL, ALTIMETER 2984 AND MDA 302,
DECISION HEIGHT 250.

59' 17" F/O: SET.

59' 18" CAP: OK.

59' 20" CAP: V-BUGS, ...
(ATC COMMUNICATION OF OTHER AIRCRAFT)

(OVERLAP) CAP: SIGN ON, IGNITION CONTINUE RELIGHT, LANDING ELEVATION.

59' 35" APP: DYNASTY 140, REDUCE SPEED TO 210 KNOTS OR LESS.

59' 39" F/O: 200.

59' 40" CAP: REDUCE 200 KNOTS, DYNASTY 140.

59' 43" APP: ROGER DYNASTY 140, DESCEND AND MAINTAIN 5000.

59' 47" CAP: CLEARED 5000, DYNASTY 140.

59' 51" CAP: LANDING ELEVATION 46, CABIN ALTITUDE 740, APPROACHING
BRIEFING.
(ATC COMMUNICATION OF OTHER AIRCRAFT)

11:00' 00" F/O: COMPLETE, SIR.
(ATC COMMUNICATION OF OTHER AIRCRAFT)

00' 02" CAP: SHOULDER HARNESSSES.
F/O: FASTEN RIGHT.

00' 05" CAP: OK, FASTEN LEFT, APPROACH CHECKLIST COMPLETED.
(ATC COMMUNICATION OF OTHER AIRCRAFT)

00' 11" CAP: YOU DO IT BY YOURSELF.
F/O: YES.
CAP: I WILL NOT BOTHER YOU. DON'T ASK ME, DO IT YOURSELF,
MAKE DECISION. I WILL REMIND YOU JUST BEFORE THE
SITUATION REACHS THE POINT THAT I CAN NOT COVER.
(ATC COMMUNICATION OF OTHER AIRCRAFT)

00' 28" F/O: YES.

00' 29" CAP: YOU DO IT BY YOURSELF, OK?

00' 30" F/O: YES, SIR.
(ATC COMMUNICATION OF OTHER AIRCRAFT)

01' 26" APP: DYNASTY 140, FLY HEADING 050.

01' 31" CAP: HEADING 050, DYNASTY 140.

(ATC COMMUNICATION OF OTHER AIRCRAFT)

01' 58" APP: DYNASTY 140, REDUCE SPEED 180 KNOTS.

02' 02" CAP: REDUCING 180 KNOTS, DYNASTY 140.

02' 07" F/O: FLAP SET, SIR.

(ATC COMMUNICATION OF OTHER AIRCRAFT)

02' 27" C/A: (CABIN ANNOUNCEMENT IN CHINESE:
ARRIVAL TIME AND WEATHER INFORMATION AT NAGOYA)

03' 06" C/A: (CABIN ANNOUNCEMENT IN ENGLISH:
ARRIVAL TIME AND WEATHER INFORMATION AT NAGOYA)

03' 27" CAP: NAGOYA APPROACH, DYNASTY 140, APPROACHING 5000.

03' 31" APP: DYNASTY 140, ROGER, MAINTAIN 5000.

03' 34" CAP: DYNASTY 140.

03' 43" [WHISTLING]

03' 57" C/A: (CABIN ANNOUNCEMENT IN JAPANESE:
ARRIVAL TIME AND WEATHER INFORMATION AT NAGOYA)

04' 03" APP: DYNASTY 140, TURN LEFT HEADING 010.

04' 06" CAP: LEFT HEADING 010, DYNASTY 140.

(ATC COMMUNICATION OF OTHER AIRCRAFT)

04' 46" C/A: (CABIN ANNOUNCEMENT IN TAIWANESE: ...)

04' 50" CAP: WAH!

04' 59" APP: DYNASTY 140, DESCEND AND MAINTAIN 4000.

05' 03" CAP: DESCEND AND MAINTAIN 4000, DYNASTY 140.

(ATC COMMUNICATION OF OTHER AIRCRAFT)

05' 27" APP: DYNASTY, SAY AGAIN AIR SPEED?

05' 31" CAP: DYNASTY 140, SPEED 180.

05' 34" APP: THANK YOU.

05' 37" APP: DYNASTY 140, NOW DESCEND AND MAINTAIN 2500.

05' 40" CAP: CLEARED TO 2500, DYNASTY 140.

(ATC COMMUNICATION OF OTHER AIRCRAFT)

07' 14" APP: DYNASTY 140, YOU ARE NOW 14 MILES FROM THE OUTER MARKER
AND CLEARED FOR ILS RUNWAY 34 APPROACH, CONTACT TOWER
118.7.

07' 21" CAP: CLEARED ILS RUNWAY 34 APPROACH, 118.7, DYNASTY 140,
GOOD NIGHT, SIR.

07' 37" CAP: GOOD EVENING, NAGOYA TOWER, DYNASTY 140, RUNWAY 34
APPROACH.

07' 42" TWR: DYNASTY 140, NAGOYA TOWER, GOOD EVENING, REPORT OUTER
MARKER, RUNWAY 34.

07' 47" CAP: REPORT OUTER MARKER, DYNASTY 140.

F/O: WAH!

08' 26" F/O: IT SEEMS AIRCRAFT QUITE OFTEN TO PICK UP OTHER'S WAKE
~~~~~  
TURBULENCE HERE, DOESN'T IT?  
~~~~~

08' 29" CAP: YOU ARE RIGHT.

08' 30" F/O: IT'S STRANGE, IS IT BECAUSE OF THE TERRAIN? TODAY, IT
~~~~~  
SEEMS WE ARE IN THE WAKE TURBULENCE FROM THE BEGINNING  
~~~~~  
TILL THE END.

08' 35" CAP: STEP FIRMLY ON THE RUDDERS, WILL BE GOOD, IT WILL NOT
~~~~~  
SWAY SO HARD.

08' 41"      CAP:      OK, LOCALIZER ALIVE.

08' 43"      F/O:      YES, SIR.

08' 47"      CAP:      LOC STAR.

08' 48"      F/O:      YES, SIR.

CAP:      RUNWAY HEADING INBOUND COURSE.

F/O:      YES, SIR.

08' 55"      CAP:      ... THAT ONE IN FRONT, WAH! YOU HAD BETTER KILL IT,  
~~~~~  
THE SPEED A LITTLE BIT.
~~~~~

08' 59"      F/O:      SIR, ISN'T IT A 747?

09' 00"      CAP:      I CAN'T TELL.

09' 01"      CAP:      YOU, YOU HAD BETTER KILL THE SPEED A LITTLE MORE.  
~~~~~  
BETTER KILL IT TO 170.
~~~~~

F/O:      170.  
~~~~~

CAP: YEAH, OTHERWISE, IF WE FOLLOW IT TOO CLOSELY, WE SHALL
~~~~~  
BE TURNED OVER.

CAP:      CORRECTION AT LOW ALTITUDE SHOULD BE DONE LITTLE BY  
~~~~~  
LITTLE. DON'T CHANGE TOO MUCH, CORRECT LITTLE BY LITTLE,
~~~~~  
AH, CORRECT LITTLE BY LITTLE AS SMOOTHLY AS POSSIBLE,  
~~~~~  
FOR, SOMETIMES AT NIGHT THERE ARE SUBCONSCIOUS ILLUSIONS.
~~~~~  
(ATC COMMUNICATION OF OTHER AIRCRAFT)

09' 50"      F/O:      WINDSHEAR.

10' 01"      CAP:      IT'S ALRIGHT, THAT...  
~~~~~  
(ATC COMMUNICATION OF OTHER AIRCRAFT)

10' 50" CAP: LATER ON YOU CONCENTRATE, CONCENTRATE TO WATCH THIS.
~~~~~



[SOUND OF SEAT ADJUSTER]

10' 53" F/O: YES, SIR.

10' 54" CAP: DON'T LOOK AT OTHER THINGS, WATCH HERE, AH, WATCH THIS  
FROM THE BEGINING TILL REACH MINIMUM THEN LOOK OUTSIDE.  
(ATC COMMUNICATION OF OTHER AIRCRAFT)

F/O: GOT IT, SIR.

CAP: RIGHT.

11' 20" F/O: GOT IT, GOT IT, WE ARE IN IT SINCE ON GLIDE SLOPE.

11' 24" CAP: WE CAN DO NOTHING ABOUT IT BECAUSE THERE ARE TOO MANY  
AIRCRAFT.

11' 26" F/O: THIS IS THE SO CALLED INTERRUPTION, ISN'T IT?

11' 28" CAP: IT'S ALRIGHT. BECAUSE...

11' 34" F/O: SIR, THEN, I DISENGAGE IT.

11' 35" CAP: OK. FLY MANUAL.

[SOUND OF AUTO PILOT SW]

11' 36" [SOUND OF AUTO PILOT DISENGAGE]  
(ATC COMMUNICATION OF OTHER AIRCRAFT)

11' 40" [SOUND OF AUTO PILOT DISENGAGE]  
(ATC COMMUNICATION OF OTHER AIRCRAFT)

11' 45" CAP: GLIDE SLOPE ALIVE.

11' 46" F/O: YES, SIR. RUNWAY GO AROUND ALTITUDE 3000 FEET.

11' 49" CAP: OK.

11' 54" CAP: OH.

11' 55" [SOUND OF ALTITUDE ALERT]

11' 57" F/O: AH, SIR, IT IS GLIDE SLOPE STAR.  
CAP: GS STAR.  
F/O: GS STAR.

12' 01" CAP: YEAH, THERE IS NO PROBLEM ANY MORE.  
[SOUND OF PITCH TRIM CONTROL SW](3 TIMES)

12' 19" CAP: OUTER MARKER. (SOUND NOTHING)  
F/O: YES, SIR.

12' 23" CAP: NAGOYA TOWER, DYNASTY 140, OUTER MARKER.  
[SOUND OF PITCH TRIM CONTROL SW](1 TIME)

12' 26" TWR: DYNASTY 140, CONTINUE APPROACH, NUMBER ONE TOUCH DOWN.

12' 30" CAP: CONTINUE, DYNASTY 140.  
[SOUND OF PITCH TRIM CONTROL SW](2 TIMES)

12' 41" F/O: FLAP 20.

12' 42" CAP: OK, FLAP 20.  
[SOUND OF SLATS/FLAPS LEVER OPERATION](2TIMES, 15/15 TO  
15/20)

12' 44" F/O: SPEED 150, PLEASE.  
(ATC COMMUNICATION OF OTHER AIRCRAFT)  
[SOUND OF PITCH TRIM CONTROL SW](1 TIME)

12' 54" CAP: 20 SET.

12' 56" F/O: GEAR DOWN.  
[SOUND OF GEAR DOWN]

13' 01" C/A: (CABIN ANNOUNCEMENT IN CHINESE: NO SMOKING )

13' 10" C/A: (CABIN ANNOUNCEMENT IN ENGLISH: NO SMOKING )  
(ATC COMMUNICATION OF OTHER AIRCRAFT)  
[SOUND OF PITCH TRIM CONTROL SW](5 TIMES)  
(ATC COMMUNICATION OF OTHER AIRCRAFT)

13' 13" CAP: GEAR DOWN, THREE GREEN.  
(ATC COMMUNICATION OF OTHER AIRCRAFT)

13' 14" F/O: 30/40, SPEED V APPROACH 140, LANDING CHECK LIST, PLEASE.  
[SOUND OF SLATS/FLAPS LEVER OPERATION](2 TIMES,  
15/20 TO 30/40)  
(ATC COMMUNICATION OF OTHER AIRCRAFT)

13' 21" CAP: LANDING GEAR DOWN, THREE GREEN, ANTI-SKID NORMAL,  
SLATS/FLAPS 30/40, SPOILERS ARMED, LANDING LIGHTS ON.  
[SOUND OF PITCH TRIM CONTROL SW](5 TIMES)

13' 25" C/A: (CABIN ANNOUNCEMENT IN JAPANESE: NO SMOKING )

13' 27" CAP: LANDING CHECKLIST COMPLETED.

13' 29" F/O: THANK YOU.  
(ATC COMMUNICATION OF OTHER AIRCRAFT)

13' 39" TWR: DYNASTY 140, CLEARED TO LAND RUNWAY 34, WIND 290 AT 6.

13' 43" CAP: CLEARED TO LAND RUNWAY 34, DYNASTY 140.

13' 47" CAP: 290 6 KNOTS.  
C/A: (CABIN ANNOUNCEMENT IN TAIWANESE: ...)

13' 48" F/O: YES, SIR.

13' 49" CAP: THERE IS A SMALL CROSS WIND FROM LEFT.

13' 57" CAP: ALL LIGHTS ON.

14' 06" CAP: EH, EH, AH.

14' 09" [CLICK CLICK CLICK](SOUND OF LANDING CAPABILITY  
CHANGE WARNING)

14' 10" CAP: YOU, YOU TRIGGERED THE GO LEVER.

14' 11" F/O: YES, YES, YES. I TOUCHED A LITTLE.

14' 12" CAP: DISENGAGE IT.

F/O: AY.

14' 16" CAP: THAT ...

F/O: AY.

14' 20" CAP: YOU WATCH, WATCH OUTSIDE, OUTSIDE.  
[SOUND OF PITCH TRIM CONTROL SW](1 TIME)

14' 23" CAP: PUSH DOWN, PUSH IT DOWN, YEAH.

14' 26" CAP: YOU, THAT...DISENGAGE THAT THROTTLE.

14' 29" F/O: UH, TOO HIGH.

14' 30" CAP: YOU, YOU ARE USING THE GO AROUND MODE.

14' 34" CAP: IT'S OK, DISENGAGE AGAIN SLOELY, WITH YOUR HAND ON.  
[SOUND OF PITCH TRIM CONTROL SW](3 TIMES)

14' 39" CAP: YOU DISENGAGED THE ENGINE THRUST?  
[SOUND OF PITCH TRIM CONTROL SW](2 TIMES)

14' 40" F/O: YES, SIR, DISENGAGED.

14' 41" CAP: PUSH MORE, PUSH MORE, PUSH MORE .

F/O: YES.

14' 43" CAP: PUSH DOWN MORE.

14' 45" CAP: IT'S NOW IN GO AROUND MODE.

F/O: YES, SIR....  
(ATC COMMUNICATION OF OTHER AIRCRAFT)

14' 49" F/O: SIR, AUTO PILOT DISENGAGED.  
(OVERLAP) [SOUND OF AUTO PILOT SW]

14' 50" [SOUND OF AUTO PILOT DISENGAGE]  
(ATC COMMUNICATION OF OTHER AIRCRAFT)

14' 51" F/O: SIR, I STILL CAN NOT PUSH IT DOWN, AY.

14' 58" CAP: I, WELL, LAND MODE?

15' 01" CAP: IT'S OK, DO IT SLOWLY.

15' 02" F/O: SIR, THROTTLE LATCHED AGAIN.

15' 03" CAP: OK, I HAVE GOT IT, I HAVE GOT IT, I HAVE GOT IT .

15' 04" F/O: DISENGAGE, DISENGAGE.

15' 08" CAP: WHAT'S THE MATTER WITH THIS?

15' 09" F/O: DISENGAGE, DIS...  
 15' 11" CAP: GO LEVER.  
 CAP: DAMN IT, HOW COME LIKE THIS?  
 [SOUND OF PITCH TRIM CONTROL SW](2 TIMES)  
 15' 14" F/O: NAGOYA TOWER, DYNASTY GOING AROUND.  
 15' 17" [GLIDE SLOPE](SOUND OF GPWS WARNING)  
 15' 18" CAP: EH?  
 (OVERLAP) TWR: ROGER, STAND BY, FURTHER INSTRUCTION.  
 [SOUND OF SLATS/FLAPS LEVER OPERATION](2~3 TIMES,  
 30/40 TO 15/0 OR 0/0)  
 15' 21" CAP: EH, IF THIS GOES ON, IT WILL STALL.  
 15' 23" [SINGLE CHIME](SOUND OF MASTER CAUTION)  
 15' 25" CAP: FINISH.  
 (OVERLAP) [SOUND OF STALL WARNING](2 SECONDS)  
 15' 26" F/O: QUICK, PUSH NOSE DOWN.  
 [SOUND OF SLATS/FLAPS LEVER OPERATION](1 TIME,  
 15/0 OR 0/0 TO 15/15)  
 15' 28" [SINGLE CHIME](SOUND OF MASTER CAUTION)  
 (ATC COMMUNICATION OF OTHER AIRCRAFT)  
 15' 31" [SINGLE CHIME](SOUND OF MASTER CAUTION)  
 (OVERLAP) F/O: SET, SET, PUSH NOSE DOWN.  
 15' 34" CAP: IT'S OK, IT'S OK, DON'T, DON'T HURRY, DON'T HURRY.  
 F/O: POWER.  
 15' 37" [TERRAIN TERRAIN](SOUND OF GPWS WARNING)  
 CAP: AH, WAH.  
 F/O: POWER, POWER. POWER.  
 15' 40" [SOUND OF STALL WARNING](CONTINUED TILL THE END  
 OF RECORD)  
 CAP: WAH, AH.  
 F/O: POWER.  
 CAP: FINISH.  
 F/O: POWER.  
 CAP: AH.  
 F/O: POWER, POWER.  
 15' 45" END OF RECORDING (NO CRASH SOUND RECORDED)

**8. Comments from France and Taiwan,  
and the Notice from the USA**

**(NOTE)**

Because of the rearrangement of the typing, pages and lines of the final report do not always correspond to those of the draft final report.

**Comments from France**

**( English version is translated by French BEA.)**

JPV/MCP  
INSPECTION GENERALE DE L'AVIATION CIVILE  
ET DE LA METEOROLOGIE

Le Bourget, le - 4 JUIL 1996

BUREAU ENQUÊTES-ACCIDENTS

N° 528 IGACEM/BEA/O

Subject : Accident of A300-600 B1816  
on 26 April 1994 at Nagoya

Encl : Comments of the BEA  
Translation into Japanese  
Translation into English

Mr Kazuyuki Takeuchi  
Chairman  
Aircraft Accident Investigation Commission  
2-1-3 Kasumigaseki, Chiyoda-ku  
Tokyo 100, Japan

Dear Mr Takeuchi,

Please find enclosed the official comments of the BEA regarding the draft report concerning the accident of China Airlines A300B4-622R, B1816 at Nagoya airport on April 26, 1994 and their translation into Japanese and into English.

I will appreciate that you take into consideration these comments or append them to the final rapport.

Yours sincerely,

Ingénieur Général de l'Aviation Civile  
Chef du Bureau Enquêtes Accidents

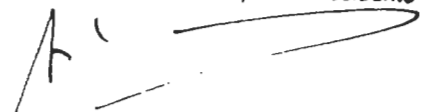

P.L. ARSLANIAN

# **COMMENTAIRES DU BUREAU ENQUÊTES ACCIDENTS (FRANCE)**

**sur le projet de rapport final  
concernant l'accident de  
l'A300B4-622R B1816 exploité par China Airlines  
survenu sur l'aéroport de Nagoya (Japon)  
le 26 avril 1994**

## **INTRODUCTION**

Le Bureau Enquêtes Accidents (France) a apprécié la possibilité qui a été donnée à ses représentants de participer à toutes les phases importantes de l'enquête, ainsi que l'esprit de coopération qui a régné au sein de la Commission d'enquête. Il remercie la Commission de lui donner l'opportunité d'étudier et de commenter le projet de rapport.

Le BEA observe que le projet de rapport final reflète en grande partie le travail réalisé. Il constate cependant, avec regrets, que certains aspects importants de l'accident sont traités de façon imparfaite, ce qui peut conduire le lecteur à une interprétation erronée des faits.

En effet, dans l'analyse, divers faits établis importants ne sont pas complètement pris en compte, ou mentionnés dans le projet de rapport, et certaines hypothèses et les éléments factuels associés ne sont pas totalement analysés. En outre, deux importantes affirmations ne sont pas en accord avec les faits établis. Ces faiblesses se retrouvent dans les conclusions et recommandations, dont certaines ne sont pas appropriées.

Les paragraphes suivants argumentent les détails de chacun de ces points et proposent les modifications correspondantes nécessaires pour le rapport final. En effet, ne pas mettre correctement en évidence tous les éléments significatifs de l'accident pourrait desservir la prévention des accidents qui est, et doit rester, le seul objectif de l'AAIC japonais et du BEA français, conformément à l'Annexe 13 de l'OACI.

(Note : Les commentaires du BEA sont basés sur la version anglaise du projet de rapport fournie par l'AAIC).



# I) ETUDES DE CERTAINES HYPOTHESES

## I-1) Introduction

Le rapport contient plusieurs hypothèses. En effet, le rôle de l'analyse est de présenter les faits, d'émettre toutes les hypothèses étayées par des éléments factuels et enfin de conclure lorsque les faits le permettent.

Pourtant, concernant trois points, les hypothèses et les éléments factuels associés ne sont pas totalement analysés :

- une hypothèse importante est omise (voir paragraphe I-2) ;
- une hypothèse importante est éliminée sans justification suffisante (voir paragraphe I-3) ;
- sur un troisième sujet, l'hypothèse la plus probable n'est pas identifiée alors que les éléments factuels le permettent (voir paragraphe I-4).

## I-2) Hypothèses omises

Au sujet des deux phrases de l'enregistreur de conversations et alarmes (CVR) : "Sir, I cannot push it down" (11h14mn51s) et "How come it is like this" (11h15mn11s), le rapport fait l'hypothèse que ces phrases se réfèrent à l'incidence élevée de l'avion.

Cette hypothèse est acceptable, mais il est beaucoup plus probable que **ces phrases fassent référence à l'effort très important et inhabituel** que le copilote et le commandant de bord ressentent au manche lorsqu'ils les ont prononcées.

Le rapport doit donc prendre en compte cette interprétation très probable.

## I-3) Hypothèse éliminée à tort

Une partie de l'analyse concerne l'explication d'une phrase en anglais extraite du CVR :  
A 11h14mn12s : le commandant de bord déclare : "**Disengage it**"

- Le projet de rapport présente au paragraphe 3.1.2.2 (2) deux hypothèses permettant d'expliquer cette phrase :
  - déconnecter le **mode Go Around**
  - déconnecter l'**automanette**

Les éléments factuels qui appuient la première hypothèse (Go Around mode) sont exposés dans le projet de rapport, mais la seconde hypothèse n'est pas débattue. Or les faits suivants appuient cette seconde hypothèse :

- le commandant de bord voulait que le copilote pilote manuellement comme indiqué par l'enregistrement du CVR entre 10h49mn00s et 10h56mn00s
- cette instruction fait immédiatement suite à la prise de conscience par le commandant de bord que la palette de remise des gaz avait été actionnée. Déconnecter l'auto-manette et ajuster manuellement la poussée des moteurs étaient alors les actions les plus logiques.
- d'autres phrases du CVR appuient cette hypothèse :  
A 11h14mn26s : " You, that... disengage that throttle"

A 11h14mn39s : " You disengaged the engine thrust?". Cette dernière phrase n'est même pas mentionnée dans l'analyse.

**Par conséquent, les faits imposent de ne pas éliminer cette hypothèse.**

- Au début de l'analyse, le projet de rapport indique correctement qu'il n'est pas possible de conclure sur ce sujet.
- Plus loin, l'hypothèse selon laquelle le commandant de bord voulait dire "déconnecter le mode Go Around" est décrite comme la plus probable, la seconde n'est plus prise en compte (fin du paragraphe 3.1.2.2 (2)).
- Enfin, cette hypothèse est exposée comme "quasiment certaine" (dans le paragraphe 3.1.2.2 (6) et les suivants). De longs développements et certaines des causes et des recommandations sont basés sur cet élément considéré comme certain, alors que ce n'est qu'une hypothèse parmi d'autres.

Ceci induit le lecteur en erreur et conduit à des conclusions qui ne sont pas étayées par les faits. Le rapport doit donc être corrigé à cet égard.

#### **I-4) Absence de conclusion sur un groupe d'hypothèses**

Le paragraphe 3.1.2.2.(4) intitulé en anglais "Concerning use of Auto Pilot" présente trois hypothèses pour expliquer l'engagement du pilote automatique à 11h14mn18s.

L'analyse de ces trois hypothèses n'est basée que sur un seul mot prononcé par le commandant de bord à 11h14mn16s : "That...", et aboutit à la conclusion qu'il n'est pas possible de déterminer qui a enclenché le pilote automatique.

Cependant, il existe dans le CVR d'autres phrases moins ambiguës, qui ne sont pas analysées pour l'instant dans le rapport. Ces phrases soutiennent la conclusion selon laquelle l'hypothèse la plus probable est que **le copilote a enclenché le pilote automatique lui-même sans instruction du commandant de bord et sans avertir celui-ci, qui n'était peut-être même pas conscient de cette action.**

En effet, du temps ca.10h49mn00s au temps 10h56mn00s, le commandant de bord encourage à plusieurs reprises le copilote à piloter manuellement. Puis, à 11h14mn20s, soit 2 secondes après l'enclenchement du pilote automatique, le commandant de bord déclare : " You watch, watch outside, outside." et à 11h14mn23s : "Push down, push it down. Yeah ". Ces instructions du commandant de bord confirment clairement qu'il croyait que le copilote pilotait manuellement, et donc, qu'il n'était pas conscient de l'enclenchement du pilote automatique.

## **II) ANALYSE INSUFFISANTE DE FAITS IMPORTANTS**

Sur deux points du rapport, les éléments factuels disponibles ne sont pas correctement présentés et analysés.

## II-1) Actions possibles qui auraient permis de récupérer l'avion

Bien que le rapport cite diverses actions possibles permettant de récupérer rapidement une attitude normale (paragraphe 3.1.2.2 (14) 5), il n'indique pas que le copilote puis le commandant de bord, lorsqu'il a été aux commandes à son tour, avaient le temps de détecter (grâce à l'effort très important et inhabituel au manche) la tendance à cabrer de l'avion et également de prendre les actions correctives.

Il aurait été utile de décrire dans le rapport les techniques de base du pilotage des avions de transport correspondant aux situations suivantes :

- a) cas où le système de vol ne se comporte pas comme prévu par l'équipage ;
- b) situation de hors-trim.

En conséquence, le contenu des paragraphes suivants devrait être exposé clairement dans le rapport :

### a) cas où le système de vol ne se comporte pas comme prévu par l'équipage

*Sur tous les avions équipés de système automatique de vol, lorsque l'équipage soupçonne un mauvais fonctionnement de celui-ci (ou lorsque la réaction de l'appareil - système automatique de vol actif- n'est pas celle que l'équipage prévoyait), il doit déconnecter le système automatique de vol et poursuivre le vol manuellement tant que les vérifications nécessaires n'ont pas été accomplies.*

*Cela fait partie des connaissances de base de chaque pilote. C'est également répété dans le Flight Crew Operating Manual (FCOM) de l'A300-600 en section 2.02.03.page 1 révision 15 dans l'avertissement sur les dangers du surpassement du pilote automatique.*

### b) situation de hors-trim

*La fonction primaire du compensateur de profondeur dans tous les avions est d'annuler les efforts au manche, afin que le pilote ne soit pas obligé d'exercer un effort continu sur celui-ci. En conséquence, à chaque fois qu'un membre d'équipage pilote manuellement et déplace le manche en profondeur, il annule instinctivement les efforts par une action sur le compensateur. Cela fait partie des connaissances de base acquises lors des toutes premières heures de formation au pilotage.*

*Le compensateur de profondeur peut être activé électriquement par un bouton situé sur une corne de chaque manche, ou manuellement en utilisant les volants du compensateur situés de chaque côté du pupitre central.*

*Il faut également noter qu'en plus de l'indicateur visuel de position du compensateur de profondeur, l'effort au manche et la position du manche à piquer au maximum (qui amène une position tendue des bras du pilote), sont des indications claires d'une situation de hors-trim. Ces indications sont communes à tous les types d'avions.*

Le FCOM de l'A300-600 recommande au chapitre "ABNORMAL AND EMERGENCY PROCEDURES" qu'en cas de réaction anormale en profondeur, l'action immédiate soit :

| <b>ABNORMAL PITCH BEHAVIOR</b>                                                                                                                                                                                                                                                               |
|----------------------------------------------------------------------------------------------------------------------------------------------------------------------------------------------------------------------------------------------------------------------------------------------|
| <ul style="list-style-type: none"><li>- Hold the control wheel</li><li>- Firmly hold the trim wheel</li><li>- Disengage AP (if engaged) and firmly hold the control wheel</li><li>- Trim as necessary using the trim wheel</li><li>- Confirm both pitch trim levers have tripped "</li></ul> |

L'action sur le volant du compensateur de profondeur (compensateur manuel) déconnecte les leviers du compensateur de profondeur et par conséquent déconnecte le pilote automatique. Ainsi cette action élimine la cause du déplacement du compensateur et en corrige les conséquences (hors trim). Cette action correctrice ne demande aucune analyse préalable de la part de l'équipage.

On peut noter que c'est cette solution qui a été utilisée avec succès par l'équipage durant l'incident de 1989.

## II-2) Actions des services officiels après des incidents précédents

Le projet de rapport décrit trois incidents survenus sur A300-600 et A310 qui présentent des similitudes avec l'accident de Nagoya (augmentation importante de l'assiette avec une situation de hors trim due à un surpassement du pilote automatique). Ces incidents se sont produits respectivement en 1985, 1989 et 1991. Le projet de rapport juge les actions entreprises par la Direction Générale de l'Aviation Civile (DGAC) pour améliorer la sécurité à la suite de ces incidents. Les affirmations sur ce point appellent les commentaires suivants.

Il est inapproprié de ne traiter que des actions de la DGAC à la suite de ces trois incidents précédents. En effet, le processus de décision a résulté de multiples facteurs et des actions de plusieurs organismes (pour les actions spécifiques au constructeur, voir le paragraphe III-1) :

1. Pour le premier incident (en 1985), aucun organisme officiel n'a été associé à l'enquête interne, et les informations disponibles n'ont pas été entièrement diffusées.
2. Le deuxième (en 1989) et le troisième (en 1991) incidents (séparés par deux années) ont fait l'objet d'une enquête par deux services d'enquête officiels différents (Finlande et Allemagne).

Dans ces deux cas, les rapports ont conclu à des causes opérationnelles.

De plus, pour l'incident de 1989 le rapport indiquait dans les faits établis que le commandant de bord était malade.

Pour le troisième incident (1991), une des conclusions concernait la coordination de l'équipage et la gestion des ressources humaines dans le cockpit. Il y était dit que "piloter et gérer l'avion avec un équipage à deux sur un appareil "glass cockpit" a mis l'équipage dans des conditions de pression excessives". Il faut noter qu'avant l'A310, les deux pilotes n'avaient volé que sur Illiouchine 18, exploité avec au moins quatre membres d'équipage.

Le rapport concernant l'événement de 1989 recommandait d'améliorer le programme d'entraînement des équipages et l'information fournie sur les dangers d'un surpassement du pilote automatique. Aucune recommandation ne demandait une modification du système automatique de vol.

Le rapport concernant l'événement de 1991 ne comportait pas de recommandation.

La DGAC a également effectué sa propre analyse de ces événements et a partagé les conclusions des autorités d'enquête.

A la suite de l'incident de 1989, en accord avec les recommandations, la DGAC et le constructeur ont amélioré le programme d'entraînement des équipages et Airbus Industrie a révisé le FCOM.

A la date du troisième incident qui s'est produit sur un A 310, le FCOM de l'A300-600 avait été modifié, et celui de l'A310 était en cours de révision (cette modification était achevée une semaine après l'incident).

En accord avec les enquêteurs, l'autorité de certification et le constructeur ont considéré que :

- Les mesures opérationnelles alors en cours, rappelées ci-dessous, et l'entraînement supplémentaire étaient des mesures correctrices adaptées à la situation :
  - \* amendement prévu du FCOM
  - \* introduction dans le programme d'entraînement (approuvé par la DGAC) d'un exercice de surpassement du pilote automatique en mode Go Around (exercice pratiqué par le copilote du B1816 durant sa qualification sur A300-600 chez Airbus Training).
  - \* développement d'une modification du pilote automatique proposée dans le service bulletin (SB n°22/6021).
- L'ajout d'une nouvelle alarme en cas de surpassement du pilote automatique ne serait pas une mesure efficace parce que de trop nombreuses alarmes s'avèrent néfastes à la sécurité, ce qui est reconnu par l'ensemble de la communauté scientifique internationale.
- Des causes annexes rendaient chacun de ces incidents très particulier.
- Des techniques de base du pilotage avaient permis de recouvrer le contrôle de l'appareil.

En conséquence, la modification proposée par le Service Bulletin 22-6021 n'a pas été rendue obligatoire.

L'incident de 1989 a été présenté pendant le séminaire annuel de l'ISASI (International Society of Air Safety Investigators) de 1990 et l'incident de 1991 a été décrit en janvier 1992 dans le magazine de la Flight Safety Foundation. A notre connaissance ils n'ont suscité aucune question et personne n'a remis en cause les conclusions des enquêteurs.

Les actions correctrices opérationnelles ont été définies à la suite de l'incident de 1989 et leur mise en place était terminée une semaine après l'incident de 1991. Il n'est donc pas correct de suggérer que l'autorité de certification française, ainsi que le constructeur, n'ont pas réagi à la suite de ces incidents et n'ont pas pris de mesures positives afin de remédier à cette situation.

### III) DECLARATIONS NON JUSTIFIEES

#### III-1) Informations fournies à l'équipage sur le surpassement du pilote automatique

Le rapport affirme que les réactions de l'équipage n'ont pas été adaptées à la situation, en partie parce que l'information qu'ils ont reçue sur le surpassement du Pilote Automatique et ses dangers n'était pas suffisante. Le Bureau Enquêtes Accidents n'est pas d'accord avec cette affirmation qui résulte des faiblesses suivantes du projet de rapport :

- l'information fournie aux pilotes n'y a pas été totalement reprise.
- en outre l'information reprise est disséminée en plusieurs endroits du projet, y compris les annexes.

Afin de donner au lecteur une vue d'ensemble, toutes les informations disponibles devraient être décrites très précisément au sein d'un même paragraphe. Ceci comprend les informations fournies aux équipages lors de leur entraînement et dans leur documentation, ainsi que les informations spécifiques envoyées aux exploitants.

1. *Au cours de la formation initiale sur simulateur, la séance n°1 (dans le programme de qualification Aéroformation) comprend une démonstration des conséquences d'un surpassement du pilote automatique en mode Go Around. Le copilote a effectué cet exercice durant sa formation sur A300-600 en 1992.*

2. *Le constructeur a fourni aux exploitants les éléments suivants concernant le surpassement du pilote automatique :*

- Le FCOM inclut des informations sur la conception des systèmes et les procédures à suivre dans chaque cas.
- A la suite de l'incident survenu en mars 1985, Airbus Industrie a émis en juin 1985 un "Operation Engineering Bulletin" (OEB n° 29/1) sur les conséquences d'un surpassement du pilote automatique, et en mars 1988 a proposé la Modification 7187.
- A la suite de l'incident de juin 1989, Airbus Industrie a envoyé un "Operator Information Telex" (OIT n° ST/999.037/89) rappelant la façon correcte d'utiliser le pilote automatique.
- Au cours de la sixième conférence opérationnelle d'Airbus Industrie, qui a eu lieu au Caire en mai 1990, ce sujet a également été traité. Deux représentants de haut niveau de China Airlines ont participé à cette conférence.
- En janvier 1991, les FCOMs ont été modifiés afin d'ajouter une mise en garde sur les dangers associés au surpassement du pilote automatique aux sections 1.03.64 page 3/4 et 2.02.03 page 1 disant :

"

#### CAUTION

*Working on the pitch axis against the auto pilot in CMD may lead to hazardous situation in LAND and GO AROUND mode .*

*So if abnormal flight control behavior is encountered during these flight phases :*

- *check AP status (FMA, FCU),*
- *if AP engaged, disconnect it and take over.*

"

- A la suite de l'incident de février 1991, Airbus Industrie a rédigé deux OIT (n° ST/999.0036/91 et n° ST 999.0048/91) rappelant la façon d'utiliser le pilote automatique.
- Le "FCOM bulletin" 05/1 (subject 10) dédié au surpassement du pilote automatique a été émis en juin 1991.
- Le 24 juin 1993, Airbus Industrie a publié le Service Bulletin 22/6021 qui comporte une modification du Flight Control Computer (FCC) permettant d'obtenir une déconnexion du pilote automatique lorsqu'un effort de plus de 15 daN est exercé sur le manche en mode Go Around au-dessus de 400 ft.

### III-2) Assertion relative au système de vol automatique de l'avion

Dans plusieurs parties du projet de rapport, le système automatique de vol est qualifié de "compliqué", sans que ce jugement soit étayé par des arguments factuels ou une analyse des faits.

Par exemple dans le paragraphe 3.1.10.2 (3), quatre arguments sont utilisés pour parvenir à la conclusion que "The training required to understand the sophisticated and complicated auto flight system was insufficient":

Les deux premiers arguments sont :

- " 1. the description in FCOM for the AFS are not easy for the crew to understand.
- 2. the crew was not given sufficient technical information with regard to similar incidents."

Or le paragraphe précédent montre que le FCOM et les documentations fournies sont parfaitement clairs en ce qui concerne le surpassement du pilote automatique en modes Land et Go Around.

Le troisième argument est :

- " 3. up to date materials were not properly obtained "

Etant donné que le copilote a bien effectué l'exercice de surpassement du pilote automatique en mode Go Around au cours de son programme de qualification, cet argument n'est pas recevable dans le cadre de l'accident.

Le quatrième argument est :

- "4. CVR transcripts show that crew understanding of the AFS was probably not sufficient"

Aucune citation précise du CVR ne vient étayer cette allégation.

En aucune manière, le qualificatif compliqué pour le système automatique de vol n'a donc été justifié.

En conclusion, nous demandons la suppression de ce qualificatif.

## IV) COMMENTAIRES SUR LES RECOMMANDATIONS

### IV-1) Remarques sur les recommandations adressées à China Airlines

Les dispositions contenues dans les recommandations adressées à China Airlines, notamment pour les aspects généraux liés à l'acquisition de l'expérience et au maintien des compétences

des pilotes, sont vraisemblablement également valables pour d'autres compagnies. Le rapport pourrait donc suggérer que toutes les compagnies aériennes examinent ces recommandations, déterminent celles qui leur sont applicables et vérifient que ces dernières sont bien mises en oeuvre au sein de leur compagnie.

#### **IV-2) Recommandation n°2-(1)1 et 2-(1)2 intitulée "Improvement of Auto Flight System functions on A300-600R".**

La première recommandation propose que le pilote automatique se déconnecte automatiquement sur un effort au manche. Le Bureau Enquêtes Accidents est entièrement d'accord avec cette recommandation, qui va dans le sens de celle qu'il a émise en juin 1994 après avoir consulté l'AAIC, et qui a été rendue obligatoire par la Consigne de Navigabilité (CN n° 94-185-165 (B)) de la DGAC. Elle sera complétée par une autre Consigne de Navigabilité française pour les hauteurs radio sonde inférieures à 400 ft.

La première partie de la seconde recommandation couvre la même idée, en termes plus généraux. Elle n'est donc pas utile.

#### **IV-3) Recommandation n°2-(1) 3 intitulée : "Improvement of warning and recognition functions for Trimmable Horizontal Stabilizer movement"**

Lorsque le pilote automatique est enclenché, il n'y a plus de possibilité d'avoir une situation de hors trim après application de la Consigne de Navigabilité CN 94-185-165 (B).

En pilotage manuel, le mouvement du plan horizontal réglable est accompagné par une indication orale (whooler) en plus du mouvement du volant du compensateur de profondeur. L'autorité de certification et le constructeur considèrent que cette indication est suffisante, et qu'il n'est pas nécessaire d'ajouter une nouvelle alarme aux indications déjà existantes (voir le paragraphe III-3-b).

#### **IV-4) Recommandation n° 2-(3) intitulée : "Positive dissemination of technical information to operators"**

Cette recommandation n'est pas étayée par les faits, en effet après chaque événement en service significatif, Airbus industrie, de la même façon que tous les autres constructeurs, fournit aux exploitants toutes les informations pertinentes. Ainsi, après l'accident de Nagoya, Airbus industrie a envoyé aux exploitants une information factuelle sur les circonstances de l'accident, ainsi que des propositions de rappels sur les conséquences possibles d'un surpassement du pilote automatique.

Il faut noter que la France considère que la diffusion efficace aux utilisateurs d'informations techniques sur les circonstances de tout accident ou incident, est de la plus haute importance pour la sécurité.

C'est pourquoi le représentant accrédité français a demandé le 3 mai 1994 que les autorités et les exploitants soient informés des circonstances de l'accident et des rappels de sécurité à effectuer, soit par la commission d'enquête elle-même, soit par l'Etat de Conception. La commission d'enquête Japonaise n'a pas donné son accord à cette requête.



#### **IV-5) Recommandation n°3 intitulée : « Auto Flight System »**

L'affirmation selon laquelle le système automatique de vol de l'A300-600 est compliqué n'est étayée par aucun fait établi lors de l'enquête.

Le développement sur le comportement humain dans les situations d'urgence est, bien sûr, totalement valable. Ceci est connu depuis longtemps et est pris en compte lors de la conception de tous les avions ainsi que dans la formation de base sur tous les pilotes de la façon suivante :

- tous les avions sont équipés de boutons de déconnexion instinctive qui permettent de déconnecter les automatismes (pilote automatique et auto-manette) rapidement et à tout moment.
- dès le début de leur formation initiale, les pilotes apprennent à déconnecter les automatismes dès qu'ils ont un doute sur leur fonctionnement correct.

Ceci correspond au concept selon lequel la conception de l'avion, l'entraînement et les procédures forment un tout indissociable.

Le Bureau Enquêtes Accidents propose la recommandation suivante, valable pour tous les avions et exploitants :

**" faire prendre conscience aux équipages, par l'intermédiaire du FCOM et de l'entraînement (initial et maintien des compétences), de l'importance de déconnecter les systèmes automatiques (pilote automatique et auto-manette) en cas d'incompréhension ou de doute concernant leur bon fonctionnement."**

#### **IV-6) Proposition de recommandation supplémentaire**

L'Annexe 8 (paragraphe 4.2.4) précise que l'Etat d'Immatriculation communique à l'Etat de Conception tous les renseignements obligatoires relatifs au maintien de navigabilité.

Cette notion est limitative puisqu'elle ne prévoit l'information de l'Etat de Conception que lorsqu'un Etat a pris une mesure d'ordre réglementaire.

Elle devrait être étendue à tous les cas où un Etat juge qu'une information sur un événement en service est utile à l'amélioration de la sécurité.

C'est pourquoi la France propose la recommandation suivante :

**" L'OACI devrait étudier un amendement à l'Annexe 8 demandant à ce qu'un Etat transmette à l'Etat de Conception toute information en sa possession et qu'il considère comme utile au maintien ou à l'amélioration de la sécurité des vols."**

## COMMENTS OF THE BUREAU ENQUÊTES ACCIDENTS (FRANCE)

on the draft report  
concerning the accident of  
China Airlines A300B4-622R, B1816  
at Nagoya airport (Japan)  
on April 26, 1994

### INTRODUCTION

The Bureau Enquêtes Accidents (France) has appreciated the opportunity that has been given to its representatives to participate in all important phases of the investigation and the cooperative spirit within the commission. The BEA thanks the commission for giving its representatives the opportunity to study and comment the draft report.

The BEA notes that the draft report reflects to a good extent the work performed. However, it points out that some important aspects of the accident are inadequately covered ; this may be misleading for its readers.

Indeed, in the analysis, some established facts either have not been totally taken into account or have not been mentioned in the draft report, and some hypotheses and the related factual elements have not been fully analyzed. Besides, two major statements are not in accordance with the established facts. These shortcomings are found in the conclusions and recommendations, some of them being inappropriate.

The following paragraphs substantiate each of these comments and, accordingly, propose the necessary amendments to the draft report. Indeed, failure to properly highlight all the relevant elements of the accident might come as a disadvantage for accident prevention which is and must remain the sole objective of Japanese AAIC and French BEA according to International Civil Aviation Organization Annex 13.

(Note : these comments are based on the English version of the draft report as provided by the AAIC).

# I) STUDY OF HYPOTHESES

## I-1) Introduction

The report contains several hypotheses. The objective of analysis is to examine the available facts, make all the hypotheses supported by factual elements, and then conclude when facts allow it.

However on three subjects, hypotheses and associated factual elements are not fully analyzed :

- one important hypothesis has been omitted (see paragraph I-2 below) ;
- one important hypothesis has been eliminated without sufficient justification (see paragraph I-3 below) ;
- on a third subject, the most probable hypothesis has not been identified, although factual evidence would allow this to be done (see paragraph I-4 below).

## I-2) Omitted hypothesis

Concerning the two quoted sentences of the Cockpit Voice Recorder (CVR) "Sir I cannot push it down"(11h14mn51s), and "how come it is like this"(11h15mn11s) the report hypotheses that it refers to the important pitch angle.

This hypothesis is acceptable, but it is much more probable that **it corresponds to the very strong and unusual effort on the control column** that the copilot and the captain were feeling when they spoke these words.

The report should thus take into account this very probable interpretation.

## I-3) Unjustified elimination of an hypothesis

A part of the analysis deals with the explanation of a phrase from the CVR :  
11h14mn12s" : Captain : " **disengage it**".

- The draft report submits two hypotheses to explain this sentence :
  - disengage **the Go Around mode**,
  - disengage **the Auto Throttle** (paragraph 3.1.2.2 (2)).

The factual elements that support the first hypothesis (Go Around mode) are presented in the draft report.

But the other hypothesis is not discussed, although it is supported by the following facts:

- the Captain wanted the F/O to fly manually, as indicated by CVR recording between ca. 10h49mn00s and ca.10h56mn00s ;
- this instruction came just after the captain realized that the Go Levers had been triggered, and in such situation, disengaging the Auto Throttle and manually adjusting the thrust were the most appropriate actions.
- other phrases of the CVR are consistent with this hypothesis :

At 11h14mn26s: " You, that...disengage that throttle"

At 11h14mn39s: " You disengaged the engine thrust ?" (this phrase is not even mentioned in the draft report)

**Consequently, the facts make it impossible to eliminate this last hypothesis.**

- At the beginning of the analysis the draft report states, correctly, that it is impossible to draw a conclusion on this matter.
- Later, the hypothesis that the Captain meant "disengage the "Go Around mode" is described as most probable, and the other hypothesis is no longer taken into account (end of paragraph 3.1.2.2 (2)).
- Finally, it is presented as "most certain" (paragraph 3.1.2.2 (6) and followings). Extensive development and sometimes causes and recommendations are then based on this element, presented as certain, whereas it is still only one hypothesis amongst others.

This presentation is misleading for the reader and leads to conclusions which are not at all supported by facts. Therefore the report must be corrected in this respect.

#### **I-4) Lack of conclusion on hypotheses**

Paragraph 3.1.2.2 (4) entitled " Concerning use of AP" submits three hypotheses to explain the engagement of the auto pilot at 11h14mn18s.

The analysis of these hypotheses is based on a single word from the captain at 11h14mn16s : "That...", and leads to the conclusion that it is not possible to determine who engaged the auto pilot .

However, there are other less ambiguous sentences in the CVR which are not presently analyzed in the draft report. These sentences support the conclusion that the most probable hypothesis is that **the F/O engaged the auto pilot himself without any instruction from and without advising the captain, who was probably not aware of it.**

Indeed, from ca.10h49mn00s to 1056:00 the captain encouraged the copilot to fly manually several times ; then at 11h14mn20s, 2 seconds after the engagement of the auto pilot , the Captain said: "You watch, watch outside, outside." and at 11h14mn23s: "Push down, push it down. Yeah ". These instructions clearly indicate that the Captain thought the F/O was flying manually, and thus, that the captain was not aware that the auto pilot was engaged.

## **II) INSUFFICIENT ANALYSIS OF IMPORTANT FACTS**

Concerning two points of the report, the available factual elements are neither accurately described nor analyzed.

## II-1) Possible recovery actions

Although the report mentions various possible actions allowing which would enable rapid recovery of a normal pitch attitude (paragraph 3.1.2.2 (14) 5), it does not indicate that the first officer and then the captain, when he himself was at the control, had time to detect (owing to the very strong and unusual effort on the control column) the pitch up tendency and also to take the appropriate corrective actions.

It would have been useful to state precisely in the report the basic piloting techniques for transport aircraft, corresponding to the following cases :

- a) automatic flight system does not behave as expected by the crew ;
- b) out of trim situation.

The following should then be highlighted in the report :

### a) Automatic Flight System does not behave as expected by the crew

*On any aircraft equipped with automatic systems, when an auto pilot malfunction is suspected by the crew (or when the aircraft behavior -controlled by the Automatic Flight System- is not what the crew expected), the crew must disconnect the automatic systems and continue the flight manually until they have carried out the necessary checks.*

*This is part of the basic knowledge of each pilot. This is also repeated in the A300-600 Flight Crew Operating Manual (FCOM) section 2.02.03 p 1 revision 15 in the Caution on auto pilot override dangers.*

### b) Out of Trim situation

*The pitch trim primary function in every aircraft is to cancel the efforts on the control column so that the pilot does not have to apply a continuous effort on it. As a consequence, each time a pilot flies manually and moves the control column in pitch he instinctively cancels the effort by an action on the pitch trim.*

*This is basic knowledge learnt during the first hours of flight training.*

*The pitch trim can be activated either electrically by a button located on one horn of each control column, or manually with the trim wheels located on each side of the central pedestal.*

*It should also be noted that, apart from the Visual indicator of pitch trim position, the effort on the control column and the full forward control column position (leading to a stretched forward position of the pilot arms) are clear indications of an out of trim situation which are common to all types of aircraft.*

*The A300-600 FCOM recommends in the chapter "Abnormal and emergency procedures", as an immediate action in case of "Abnormal Pitch Behavior" :*

| ABNORMAL PITCH BEHAVIOR                                                                                                                                                                                                                                                                    |
|--------------------------------------------------------------------------------------------------------------------------------------------------------------------------------------------------------------------------------------------------------------------------------------------|
| <ul style="list-style-type: none"><li>- HOLD THE CONTROL WHEEL</li><li>- FIRMLY HOLD THE TRIM WHEEL</li><li>- DISENGAGE AP (if engaged) AND FIRMLY HOLD THE CONTROL WHEEL</li><li>- TRIM AS NECESSARY USING THE TRIM WHEEL</li><li>- CONFIRM BOTH PITCH TRIM LEVERS HAVE TRIPPED</li></ul> |

*The action on the trim wheel (manual trim) disconnects the pitch trim levers and as a consequence the auto pilot. It thus cancels the cause of the trim movement and at the same time corrects the consequence (out of trim). This corrective action does not necessitate any preceding analysis.*

*It can be noted that this solution was successfully used by the crew during the 1989 incident.*

## **II-2) Action of authorities after previous incidents**

The draft report describes three incidents on A300-600 and A310 which have some similarities with the Nagoya accident (important pitch up with an out of trim situation due to an auto pilot override). They took place, respectively, in 1985, 1989 and 1991. The draft report carries judgments on the actions the DGAC undertook in order to improve safety after these incidents. The statements made in this context require the following commentaries.

It is inappropriate to deal with the actions of the DGAC in isolation after these three incidents, as the decision making process resulted from multiple factors, and from the actions of several organizations (for specific action taken by the manufacturer, please refer to paragraph III-1) :

1. For the first (1985) incident no official organization participated in the internal investigation, and the available information was not fully disclosed.
2. The second (1989) and the third (1991) incidents (separated by two years) were investigated by two different accident investigation authorities (Finland and Germany).

In both cases the reports concluded that the causes were operational.

Moreover, for the 1989 event, the report indicated, among the findings, that the Captain was ill.

For the 1991 event, there was a finding concerning crew coordination and cockpit resource management. It stated that *"flying and managing the aircraft with a 2-man crew "glass cockpit" had put them (the crew) under excessive pressure"*. It should be noted that both pilots had all their flight experience (before A310) on Ilyushin 18's, with at least 4 crew members.

The report on the 1989 event recommended improving the crew training program and the information on the dangers of overriding the auto pilot. There was no recommendation asking for a modification of the Auto Flight System.

The report of the 1991 event included no recommendation.

DGAC also conducted its own analysis of the events and agreed with the conclusions of the investigating authorities.

After the 1989 incident, in accordance with the recommendations, the DGAC and the manufacturer amended the training program and Airbus Industrie revised the FCOM.

At the date of the third incident which occurred on an A310, the FCOM revision was implemented on A300-600, but was in progress on the A310 (the revision was carried out one week later).

In line with the investigators, the airworthiness authority and the manufacturer considered that :

- The following operational measures in progress at that time, and additional training were adequate corrective measures :
  - \* scheduled FCOM amendment ;
  - \* introduction into the training program (approved by DGAC) of an auto pilot overriding exercise in Go Around mode (this exercise was performed by the copilot of the B1816 during his qualification on A300-600 at Aéroformation) ;
  - \* development of an auto pilot modification proposed in Service Bulletin SB 22-6021.
- Adding a supplementary alarm in case of auto pilot overriding would not be effective, because having too many alarms is prejudicial to safety, a point which is widely agreed upon by the international scientific community.
- Some side causes made each of these events very particular.
- Basic flying techniques allowed the control of the aircraft to be recovered.

Consequently, the modification proposed in Service Bulletin SB 22-6021 was not made mandatory.

The 1989 incident was presented during the 1990 annual seminar of the International Society of Air Safety Investigators and the 1991 incident was described in the January 1992 magazine of the Flight Safety Foundation. To our knowledge, no question was raised and nobody disputed the analyses and conclusions of the investigators.

The corrective operational measures had been defined after the 1989 incident and were fully implemented one week after the 1991 incident. Therefore it is not correct to suggest that the airworthiness authority and the manufacturer did not react to these incidents and did not take positive measures to cope with the situation.

### III) UNSUBSTANTIATED STATEMENTS

#### III-1) Information to crew on auto pilot override

The report states that the crew's reaction was inadequate partially because their information on auto pilot override and its dangers was not insufficient. The BEA disagrees with this statement which is the result of the following shortcomings in the report :

- the information provided to the pilot is not fully described ;
- moreover, the information produced is spread over several sections including the appendices. In order to provide a better overview, all the available information should be stated very precisely within one paragraph. This includes the information given in the training and presented in the manuals and the specific information sent to the airlines.

1. *During initial training in simulator session n°1 (Aéroformation qualification program) there is a demonstration of the consequences of auto pilot override in Go Around mode. The copilot performed this exercise during his A300-600 qualification training in 1992.*
2. *The manufacturer provided the airlines with the following elements dealing with auto pilot overriding :*
  - *The FCOM includes information on systems design and procedures to be applied in each case.*
  - *After the March 1985 incident, Airbus Industrie issued in June 1985 an Operation Engineering Bulletin (OEB n° 29/1) on the consequences of an auto pilot override and in March 1988 proposed the Modification 7187.*
  - *After the June 1989 incident, Airbus Industrie sent an Operator Information Telex (OIT n° ST/999.037/89) reminding crew how to use the Auto Pilot.*
  - *During the 6th Airbus Industrie Operational Conference that took place in Cairo in May 1990, this subject was also treated. Two fully competent representatives of China Airlines attended this conference.*
  - *In January 1991, the FCOMs were amended to include a Caution about auto pilot overriding in section 1.03.64 page 3/4 and section 2.02.03 page 1 "CAUTION saying :*

**CAUTION**

*Working on the pitch axis against the auto pilot in CMD may lead to hazardous situation in LAND and GO AROUND mode.*

*So if abnormal flight control behavior is encountered during these flight phases :*

- *check AP status (FMA, FCU),*
- *if AP engaged, disconnect it and take over".*

- *After the February 1991 incident, Airbus Industrie issued two OIT (n° ST/999.0036/91 et n° ST 999.0048/91) reminding crew how to use the auto pilot .*



- The FCOM bulletin 05/1 (subject 10) dedicated to auto pilot overriding was issued in June 1991.
- Airbus Industrie issued on 24 June 1993 Service Bulletin 22/6021 which includes a modification to the Flight Control Computer (FCC) "to provide auto pilot disengagement by applying a 15 daN force on the control column in Go Around mode above 400 ft Radio Height".

### **III-2) Statement made concerning the aircraft Auto Flight System**

In several parts of the draft report, the Auto Flight System is qualified as "complicated" without any factual or analytical argument to support this statement.

For example in paragraph 3.1.10.2 (3), four arguments are provided to support the conclusion that « the training required to understand the sophisticated and complicated Auto Flight System was insufficient. » :

The first two arguments are :

- "1 the description in FCOM for the Auto Flight System are not easy for crew to understand*
- 2 the crew was not given sufficient technical information with regard to similar incidents"*

However, we have shown in the previous paragraph that the FCOM and the documentation provided are perfectly clear concerning auto pilot override in Land and Go Around mode.

The third argument is :

- "3 up to date materials were not properly obtained"*

As the copilot really performed the exercise of Auto pilot override in Go Around mode during his qualification, this argument is not relevant to this accident.

The fourth argument is :

- "4 CVR transcripts show that crew understanding of the Auto Flight System was probably not sufficient"*

There is no precise quotation on the CVR to support this allegation.

Defining the Auto Flight System as "complicated" has, in no way, been justified.

In conclusion, the BEA asks for the deletion of this statement.

## **IV) COMMENTS ON THE RECOMMENDATIONS**

### **IV-1) Comments about the recommendations directed to China Airlines**

The provisions contained in the recommendations addressed to China Airlines, concerning in particular the general aspects linked to experience gaining and skill maintenance of crew, are probably also applicable to other airlines. The report could thus suggest that all airlines study these recommendations, determine those which are applicable to them and verify that those particular ones are indeed implemented within their company.

#### **IV-2) Recommendation n° 2-(1)1 and 2-(1)2 on "Improvement of Auto Flight System functions on A300-600R"**

The first recommendation proposes an automatic disengagement of the auto pilot under effort on the control column.

The BEA concurs with that recommendation. It is consistent with the one issued by the BEA in June 1994 after consultation with the AAIC, which was implemented through French Airworthiness Directive CN 94-185-165(B). This Airworthiness Directive is being supplemented by another one for radio-height lower than 400 feet.

The first part of the second recommendation covers the same idea, but in more general terms and is therefore not useful.

#### **IV-3) Recommendation n° 2-(1) 3 on "Improvement of warning and recognition functions for Trimmable Horizontal Stabilizer movement"**

When auto pilot is engaged, it is no longer possible to be in an out of trim situation after the implementation of Airworthiness Directive CN 94-185-165(B).

In manual flight the Trimmable Horizontal Stabilizer movement is highlighted by an aural indication (whooper) in addition to the trim wheel motion. The airworthiness authority and the manufacturer have indicated that this is an adequate indication of the Trimmable Horizontal Stabilizer movement and that it is not useful to add a supplementary warning to the existing indications (refer to paragraph III-3 b).

#### **IV-4) Recommendation n° 2-(3) on "Positive dissemination of technical information to operators"**

This recommendation is not supported by the facts. Indeed after each significant "in service event", Airbus Industrie, just like all the other aircraft manufacturers, provides its operators with the relevant information. So, after the Nagoya accident, Airbus Industrie provided its operators with factual information on the circumstances of the accident as well as with proposals for reminders on the possible consequences of auto pilot overriding.

It must be noted that France considers that positive dissemination of technical information on the circumstances of any accident/incident is most important for Safety. This is why the French Accredited Representative requested on May 3, 1994 that the authorities and operators be informed of the circumstances of the accident and of safety reminders, either by the investigation commission or by the State of Design. The investigation commission did not agree with this request.

#### **IV-5) Recommendation n°3 on Auto Flight System**

The assumption that the Auto Flight System of the aircraft is complicated is not supported by any of the facts established during the investigation.

The commentary in recommendation number 3, on human behavior in emergency situations is of course fully valid. This has been known for a long time and is taken into consideration in the design of all aircraft and in basic training of all pilots in the following way :

- every aircraft is equipped with instinctive disconnect buttons which allow the pilot to disconnect the auto flight systems (auto pilot and auto throttle) rapidly at any time ;
- as early as their initial training, pilots learn to disconnect automatic systems as soon as they have any doubt on their operation.

This corresponds to the fundamental basis that design cannot be dissociated from training and procedures.

The BEA proposes the following recommendation, valid for all types of aircraft and operators :

**highlight to pilots in the FCOMs and during their training (both initial and recurrent) the importance of disconnecting automatic systems (auto pilot and auto throttle ) in case of lack of understanding or doubt concerning their operation.**

#### **IV-6) Proposal of supplementary recommendation :**

Annex 8 to the Convention on International Civil Aviation states that (paragraph 4.2.4) the State of Registry shall transmit to the State of Design all mandatory continuing airworthiness information.

This notion is restrictive because it specifies that the State of Design is informed only when a State has taken a mandatory measure.

It should be widened to include all cases where a State judges that information concerning an " in service event " is useful for safety improvement.

Therefore, France proposes the following recommendation :

**"International Civil Aviation Organization study an amendment to Annex 8 to request that a State forwards to the State of Design any information in its possession, which it considers to be useful to maintain or improve flight Safety."**

**Comments from Taiwan**

The following addendum is sent from Taiwan to Aircraft Accident Investigation Commission by way of the route between the Association of East Asian Relations and the Interchange Assosiation.

Addendum to Aircraft Accident  
Investigation Report  
China Airlines Airbus A300 B4-622R, B-1816, April 26, 1994

Comments by Lee, Wan-Lee, Accredited Representative

June 17, 1996, Civil Aviation Administration

## Summary of Comments

In the cover letter of this Addendum, dated as of June 17, 1996, addressed to Mr. Shoji Sugie, Chief Investigator of Aircraft Accident Investigation Commission of Ministry of Transport, with the signature of Mr. Lee as the Accredited Representative, it reads that as the Accredited Representative, Mr. Lee is, in general, in agreement with the contents of the accident investigation draft report made by the Aircraft Accident Investigation Commission on the accident to CAL A300 B4-622R B-1816, but considers that the following comments are necessary in order to provide appropriate balance to the draft report, and that it is considered that if the substance of these comments had been reflected in the draft report, it would have been acceptable.

1. Technical. (Appendix A)

The comments under this section are provided in the interest of technical or linguistic clarity of the English translation of the draft report, or to ensure parity of content with the originating Japanese version.

2. Issues of concern. (Appendix B)

The comments under this section are provided to expand on those areas of analysis of the factual information which are felt to require additional comment or, in some cases, alternative interpretation. For the most part, these items reflect analysis of the factual information relevant to the accident from the point of view of accepted norms of professional pilot operations and established human factors criteria.

3. Analysis and conclusions.

While the draft report appears to adhere to the format suggested by ICAO Annex 13, insofar as presentation of **Factual Information** and **Analysis** are concerned, it is considered to be less than rigorous with respect to the subsequent derivation of **Findings and Causes (Conclusions)** based upon analysis of the factual information. In some cases, the specified causes seem to be intuitively derived without basis in previously presented analysis or factual information. The first portion of Section 4, Causes, contains what could more properly be called a Synopsis of the accident, while the subsequent list of causes contains cause factors which, although they may have some bearing on the accident, do not pass the test of: "If this cause factor was not present, this accident would NOT have taken place." Accordingly, Appendix C is submitted as an alternative, and hopefully more rigorous, list of findings and cause factors, based on analysis of the facts, along with a suggested synopsis.

## Appendix A

### TECHNICAL

#### A.1 General

This Appendix contains comments concerning technical or linguistic clarity of the English translation of the draft report, or to ensure parity of content with the originating Japanese version.

#### A.2 Report Section 2 Factual Information

Page 2.2 second last line: ...dive. Should be replaced by:... a steep descent.

Page 2.3 first line: ...crash. Should be replaced by:... impact.

Page 2.3 second line: ...crashed into the landing zone. Should be replaced by:... impacted the ground on the airfield.

Page 2.3 third line: ...landing zone. Should be replaced by:...airfield.

Page 2.18 after paragraph 2.7.2: there should be an additional paragraph:

##### 2.7.3 Natural lighting conditions.

Night conditions, with broken cloud cover above 3,000 feet, prevailed during the approach of CI-140, and subsequent to the accident. Visibility was 20km.

Page 2-34 Paragraph 2.16.3 (2) should read:

- (2) When the AP is in the LAND or GO AROUND mode, it is possible to override the AP by a force applied to the control wheel. However, this is hazardous because the AP remains engaged and the THS automatically trims to maintain the scheduled flight path against the pilot commanded deflection of the elevator. In the Flight Manual and FCOM, cautionary information is included to call attention to this situation.

In this connection, Airbus Industrie notified all airlines concerned in February 1991 that this information should be added to the FCOM as a "CAUTION". Following this notification, China Airlines revised the FCOM in April, 1991. (Refer to Appendix 2-2)

#### A.3 Report Section 3 Analysis

Page 3-2 1108:26 - 1110:54 Spelling — themselves

Page 3-4 1114:23 last line: ...down... should be ...forward...

Page 3-7 line 4 "NO MORE VALID" should be; "INVALID"

Page 3-7 line 6 ...fell into... should be; ...entered...

Page 3-8 line 4 ...the aircraft crashed... should be; ...ground impact occurred...

Page 3-8 Section 3.1.2.2 (1), 5th paragraph ...manual thrust, or that... should be: ...manual thrust, or due to turbulence, or that...



- Page 3-10 Para (6) ② ...modes led AP... should be: ...modes would have caused AP...
- Page 3-10 Para (6) 2nd para, first line ...mode, either lateral mode or longitudinal... should be: ...mode, both a lateral mode and a longitudinal... (Ref 3.1.11.4 (3) ②)
- Page 3-11 Para ② line 5 ...push-down...should be ...nose-down...
- Page 3-11 Para ③ line 8 GO AROUND mode was engaged... should be: The AP was engaged into the GO AROUND mode...
- Page 3-25 4th line from bottom of page ...considered that... should be: ...considered possible that...
- Page 3-36 Para (4) line 7 ...button, or... should be: ...button (which is incorrect, since this action does **not** disengage GO AROUND guidance - reference (3) ② ),or...
- Page 3-37 Section 3.1.11.7, second para ...stabilize the longitudinal aircraft attitude... should be: ...provide improved longitudinal static stability...
- Page 3-43 Para 3.2.1.4 should read:
- 3.2.1.4 Meteorological Information
- (1) Weather  
It is established that weather during the time of the approach had not contributed to occurrence of the accident.
- (2) Natural lighting conditions  
The fact that the approach to Nagoya was conducted in night conditions, with cockpit lighting subdued to preserve outside night vision of the crew, impaired the ability of the crew to discern fine detail in the cockpit, e.g. flight control movement, facial features and other items not specifically illuminated.
- Page 3-45 Section 3..2.5, first line ...There is a possibility ... should be: ...It is probable ...
- A.3 Items incorrectly translated into English from the originating Japanese version
- Page 3- 8 "A/THR" is "ATS" in Japanese version
- Page 3- 8 last line: "by the F/O" is deleted in Japanese version
- Page 3- 10 10th line from bottom of page "the F/O's operation" is "the crew's operation" in Japanese version
- Page 3- 11 Para ② last line: "... -5.3°." Is "... -5.3°, pitch trim control switch was not activated. " in Japanese version
- Page 3- 12 Para (8) title adds: "(Refer to 3.1.11.6 and 3.1.11.7)" in Japanese version
- Page 3- 12 Para (8) 5th line from bottom of page: "...moment." is: "...moment, several minutes after AP was disengaged."in Japanese version
- Page 3- 16 Para ⑤ third line: "hesitated to" is "could not" in Japanese version

## Appendix B

### ISSUES

#### B.1 General

This Appendix contains comments provided to expand on those areas of analysis of the factual information which are felt to require additional comment or, in some cases, alternative interpretation. For the most part, these items reflect analysis of the factual information relevant to the accident from the point of view of accepted norms of professional pilot operations and established human factors criteria.

#### B.2 Concerning out-of-trim resulting from GO AROUND thrust.

The phenomenon of out-of-trim resulting from GO AROUND thrust is recognized in the report as a contributing factor to the out-of-control steep climb which resulted in stall and subsequent crash (Paragraph 3.2.7.3, and Section 4, Cause #8), yet surprisingly, it is not taken into account in the analysis of events immediately following activation of the GO LEVER (Paragraph 3.1.2.2 (7)).

##### B.2.1 GO AROUND thrust pitching moment.

The nose-up pitching moment produced by increase of power to GO AROUND thrust is an undesirable characteristic of aircraft of low-wing design which have engines mounted below the wing (A300, B-737, B-747, etc). The extent to which this characteristic is annoying or hazardous is determined by the distance of the centerline of thrust below the CG of the aircraft (or the compensating features of the flight controls design employed to reduce the out-of-trim effect). Other aircraft, which have thrust centerlines much closer to the fore and aft axis (of the aircraft) such as the DC-9, VC-10 etc. exhibit this characteristic to a much lesser extent.

##### B.2.2 A300-600R GO AROUND thrust pitching moment.

It is widely recognized amongst pilots who fly the A300-XXX series of aircraft that manual control of the aircraft in a go around is "a real handful"; the manufacturer cautions that great care must be used during go around to avoid excessive pitch attitudes. It is not surprising then, for the inexperienced pilot to have difficulty controlling the longitudinal axis after inadvertent or even deliberate activation of a go lever, as the history of previous incidents illustrates.

##### B.2.3 Masking of onset of THS out-of-trim

In the presence of the large out-of-trim effect (column force feel increase) due to change of thrust to GO AROUND power the **initial** out-of-trim effect caused by movement of the THS was therefore **not detectable** without some alternative form of indication (other than tactile).

#### B.3 Concerning disregard of duty assignment and CRM

It is acceptable practice, during airline operations, for the captain to delegate flying responsibility to the copilot so as to ensure his currency and competency as a back-up pilot in the event of incapacitation of the captain; and so the captain becomes CAP(PNF) while the FO becomes FO(PF).

In such an event the captain still retains **total responsibility** for the safe conduct of the flight, and so it is not only **appropriate** but mandatory, from the point of view of safety, for him to give instructions to the FO (coaching) to correct errors in aircraft handling — off centerline, above visual approach path, etc. If the captain were to take control at the first indication of error, then there would be no future captains, since the confidence of the FO would be destroyed, and his opportunity to mature as a pilot eliminated.

And so in the case of B-1816 the captain was exercising appropriate cockpit resource management (CRM) techniques by improving his FO's flying ability through practice, preceded by well thought out and comprehensive briefing. Contrary to the arguments presented in Paragraphs 3.1.2.2 (15) ⑤, and 3.2.3 (5), the captain was still Pilot in Command, and allowed the FO to continue to fly (PF).

#### B.4 Concerning take over of control by the captain.

The contention is made, and indeed a cause factor is assigned, to the effect that the takeover of control by the captain was delayed (Paragraphs 3.1.2.2 (12) ③, 3.1.10.1 (2) and Section 4, cause #7).

The criteria for take over of control by the captain are described in the China Airlines Operations Policy Manual and described in the report in Paragraph 3.1.10.1 (2) ④ 5), and it was established from CVR data that he "...took over the controls to deal with the abnormal situation,..." in **exact accordance** with these criteria. In other words, the captain appropriately took control when he **detected** the abnormal situation.

##### B.2.3 Detection of THS out-of-trim by the captain

The senses realistically available to the captain for the purposes of detection of the out-of-trim abnormal situation are visual, tactile, and aural. Indications which would have triggered recognition of the abnormal situation are as follows:

###### B.2.3.1 Visual cues:

- ① Runway environment — since the captain was in visual contact with the touch down zone of the runway, and the aircraft appeared to be proceeding in the correct direction there was no cause for alarm.
- ② Speed — a variation in speed was not to be unexpected as a result of power and glide path angle changes. Speed did not become critical until shortly before the captain's take over of control.
- ③ FMA indications — since visual contact with the runway was firmly established the AFS guidance information was of secondary priority, as briefed to the FO prior to descent.
- ④ THS position — the THS position indicator was not visible ( not illuminated, and out of the captains primary field of view) in the darkened cockpit.
- ⑤ THS trim wheel movement — similarly , the trim wheels were not visible ( not illuminated, and out of his primary field of view) in the darkened cockpit.

###### B.2.3.1 Tactile cues:

- ① Control Force — since the captain was PNF he could not feel the unusual control forces which the FO was experiencing.
- ② Control Position — since the captain was PNF he could not detect any unusual control position as a result of darkness.
- ③ Aircraft buffet — the approach was being conducted in the turbulence generated by the passage of a previous aircraft

###### B.2.3.1 Aural cues:

- ① Information from the FO — the FO was too occupied with trying to make sense of what he was feeling on the controls, or nervous, or embarrassed by his error, to inform the captain in timely fashion of his difficulty.
- ② THS trim movement warning— the normal THS movement warning was inhibited with AP engaged.

Given the absence of an indication that something was abnormal, and the desire of the captain to avoid unnecessarily taking control away from the FO, it is not surprising that he took control when he did, in effect when he **detected** the abnormal situation. Additionally the recorded data indicate professional coordination between the pilots, until the lapse of communication due to a totally unexpected sequence of events.

## **Appendix C**

### **CONCLUSIONS**

#### **Findings**

#### C.1 General

This Appendix contains findings of significance relative to the accident derived from the factual information presented in Section 2, and from the analysis of data and factual information presented in Section 3 .

##### C.1.1 Crew qualification

The flight crew had valid airmen proficiency certificates and valid airman medical certificates.

##### C.1.2 Aircraft qualification

The aircraft possessed a valid airworthiness certificate and had undergone maintenance and inspection as specified.

##### C.1.3 Aircraft serviceability

From the result of the investigation, the aircraft had no known failures or malfunctions that had any relevance to the accident either before or during its occurrence.

##### C.1.4 Meteorological Information

###### C.1.4.1 Weather

It is established that weather during at the time had not contributed to occurrence of the accident.

###### C.1.4.2 Natural lighting conditions

The fact that the approach to Nagoya was conducted in night conditions, with cockpit lighting subdued to preserve outside night vision of the crew, impaired the ability of the crew to discern fine detail in the cockpit, e.g. flight control movement, facial features and other items not specifically illuminated, including the THS position indicator, and THS manual trim wheel movement.

#### C.2 Flight of the Aircraft

##### C.2.1 Approach to Nagoya

###### C.2.1.1 Conditions prior to GO lever actuation

It is established that, prior to GO lever actuation, the aircraft was in a normal condition and configuration, and had been cleared by ATC, for an ILS approach (in VMC conditions) to Runway 34 at Nagoya; all appropriate checklists had been completed and the F/O(PF) had been appropriately briefed by the CAP(PNF) on the procedures and techniques for a manually controlled approach and landing.

###### C.2.1.2 Approach Conditions

It is established that the aircraft experienced wake turbulence from a preceding aircraft during the approach to Nagoya.

###### C.2.1.3 GO lever actuation

It is established that, while the aircraft was making an ILS Runway 34 night approach to Nagoya Airport under manual control by the F/O(PF), the F/O(PF) inadvertently activated the GO lever.

#### C.2.1.4 GO lever actuation

It is established that the design (spring force gradient) and location (underneath the throttles) of the GO levers permits inadvertent operation.

#### C.2.2 Result of GO lever activation.

##### C.2.2.1 Out-of-trim due to engine thrust.

It is established that, as a result of GO lever activation, engine thrust increased towards GO AROUND power resulting in a nose-up out-of-trim situation due to the nose-up pitching moment caused by location of the engine centerline below the fore and aft axis of the aircraft.

##### C.2.2.2 FD GO AROUND operation.

It is established that GO lever activation caused engagement of the FD into the GO AROUND mode providing, in this case, undesired GO AROUND AFS operation and guidance away from the ILS glideslope.

##### C.2.2.3 Actions of F/O(PF) after activation of the GO lever.

It is established that, subsequent to activation of GO lever, the F/O(PF) exerted nose-down pressure on the control wheel which resulted in the aircraft leveling off, after deviation above the glide path.

#### C.2.3 Action of CAP(PNF) after activation of the GO lever.

It is established that the CAP(PNF) detected the engagement of GO AROUND mode and directed F/O(PF) to disengage it. The AP was later engaged by the F/O(PF), with no indication of disengagement of the GO AROUND mode.

#### C.2.4 Autopilot Engagement

It is established that the AP was engaged by the F/O(PF). It is probable that AP selection was an instinctive reaction to the confusing situation due to limited manual flight experience.

#### C.2.5 Attempt by F/O(PF) to correct aircraft flight path.

##### C.2.5.1 Action of the F/O(PF)

It is established that the F/O(PF) continued to exert forward pressure on the control wheel, in an attempt to correct the descent path, in part because he tried to follow the CAP(PNF)'s direction.

##### C.2.5.2 Auto Throttle disconnect.

It is established that the F/O disengaged ATS and retarded the thrust levers, which eased the out-of-trim condition due to engine thrust, and permitted descent toward the glide path.

##### C.2.5.3 Action of the THS

It is established that, as a result of F/O(PF) forward pressure on the control wheel while the AP was engaged the THS moved, **without warning** since the auto pilot was engaged, to the full nose-up position, bringing about an out-of-trim situation.

#### C.2.6 Out-of-trim due to THS

It is established that the AP was disengaged, and as a result of the continued existence of the out-of-trim situation due to THS, speed decreased, and pitch angle and angle of attack increased to a degree at which the alpha floor function was activated.

#### C.2.7 Disengagement of the GO AROUND mode.

##### C.2.7.1 GO AROUND mode Disengagement by crew

It is established that despite actions of the CAP and F/O in an attempt to disengage the GO AROUND mode, the GO AROUND mode remained engaged.

### C.2.7.2 Crew call outs.

It is established that, after the activation of the GO lever, the F/O did not respond appropriately to then CAP's command: "disengage it" by confirming the result of the action taken to satisfy the intent of the CAP's command, additionally the CAP did not confirm that the action had been completed, and did not perform the operation or selection himself.

### C.2.7.2 Crew experience in GO AROUND mode disengagement

It is established that the crew had limited experience in GO AROUND mode disengagement due to absence from the training syllabus of the requirement for such training, and the rarity of the necessity for go around in normal operations.

### C.2.8 Flight Crew Operating manual (FCOM).

It is established that the FCOM published by the manufacturer for use as the aircrew operating guide, contained information relevant to procedures involved in the accident which was confusing and contradictory.

#### C.2.8.1 Supervisory Override — FCOM 1.03.64 page 3/4 Apr 95

This reference presents the Supervisory Override Function as an optional operational use of the AFS:

This function is intended to permit pilots to apply small manual control inputs to assist the autopilot in capturing the glide slope and localizer.

This function is available with AP in CMD in the following cases:  
lateral : in VOR mode and (in LOC capture and track phases of LOC and LAND modes (LOC\* or LOC on FMA))

yet on the same page, immediately beneath the description of the function, has been added a contradictory:

#### CAUTION

To prevent guidance disturbance do not apply a force on the control column during LOC phase.

While section 2.02.03 page 1 Rev 15, contains a further contradiction, (Procedures and Techniques, Main Rules of Use, Paragraph 9):

.....But working against the AP is definitely not a normal procedure and should be avoided.

#### C.2.8.2 Abnormal Pitch Behavior

It is established that the FCOM contains no EMERGENCY procedure to provide a guide to the pilot for the **immediate** action implicitly required to escape from the **hazardous** (FCOM 1.03.64: CAUTION) situation resulting from AP override out-of-trim (caused by THS autotrim against the pilot).

### C.2.9 Detection of the out-of-trim condition by the F/O(PF)

It is established that the F/O(PF) did not detect the out-of-trim condition due to THS by any of: change in column force feel, visual means, or by aural warning.

#### C.2.9.1 Masking of onset of THS out-of-trim

It is established that the initial out-of-trim effect (column force feel increase) caused by movement of the THS, occurred during a large out-of-trim effect due to the nose-up pitching moment associated with increase of thrust to GO AROUND power, and was therefore not detectable by the F/O(PF).

#### C.2.9.2 Lighting conditions

It is established that the F/O(PF) did not detect the movement of the manual trim wheel resulting from THS autotrim operation since neither **trim wheel** nor **THS position indication** was visible to him as the cockpit lighting level was set for night operation.

#### C.2.9.3 Aural Warning

It is established that the F/O(PF) did not detect the movement of the manual trim wheel resulting from THS autotrim operation because the **normal** aural warning of THS motion was **inhibited** by design during AP CMD operation.

#### C.2.10 Detection of the out-of-trim condition by the CAP(PNF)

It is established that the CAP(PNF) did not detect the out-of-trim condition due to THS by any of: visual or tactile (touch) means, or by aural warning.

##### C.2.10.1 Lighting conditions

It is established that the CAP(PNF) did not visually detect the of the out-of-trim condition resulting from THS autotrim operation since the level of force (manifested by arm extension, type of grip on the control wheel, facial expression etc.) exerted by the F/O(PF) was not visible to him as the cockpit lighting level was set for night operation.

##### C.2.10.2 Lighting conditions

It is established that the CAP(PNF) did not detect the movement of the manual trim wheel resulting from THS autotrim operation since neither **trim wheel** nor **THS position indication** was visible to him as the cockpit lighting level was set for night operation.

##### C.2.10.3 Aural Warning

It is established that the CAP(PNF) did not detect the movement of the manual trim wheel resulting from THS autotrim operation because the **normal** aural warning of THS motion was **inhibited** (by design) during AP CMD operation.

#### C.2.11 Assumption of control by CAP

It is established that the CAP assumed control after the F/O **communicated his inability to correct the aircraft flight path**. At the time of taking control his initial intention to continue the approach was indicated by his retarding the thrust levers. The instant relief from nose-up pitch rate was rapidly replaced by his recognition of the abnormal energy state of the aircraft which caused him to abort the approach and initiate go around.

#### C.2.12 Out of control climb

##### C.2.12.1 Out-of-trim due to THS and Alpha Floor power.

It is established that at the time of assumption of control of the aircraft by the CAP(PF) the THS was in the maximum nose-up out-of-trim situation. Subsequent activation of the alpha floor function due to high AOA produced an additional increase in the out-of-trim condition as a result of the large nose-up pitching moment from high power. The combined out-of-trim caused uncontrollable nose-up pitch rate followed by a steep, decreasing speed climb.

##### C.2.12.2 Flap operation during go around

It is established that in response to the "GO lever" call out by the CAP there was some delay (approximately 7 seconds) before the flap lever was moved by the F/O to a go around flap setting, and that the FLAPS AND SLATS lever was moved through several detents before being set to the 15/15 position.

### C.2.13 Timing of decision to take control

It is established that the CAP delayed his decision to take control until the F/O communicated his inability to correct the aircraft flight path. It is logical to assume that the reasons were that:

- (1) He had visual contact with the runway and airport.
- (2) He was attempting to allow the F/O to have the opportunity to correct the flight path and continue the approach. To do so it was necessary for him to continually assess the relationship between aircraft position and altitude and the desired flight path to the runway; in this case, since visual contact with the runway environment was already established, a **visual** task regardless of what guidance was presented by the AFS or FMA.
- (3) The apparent correction of the flight path caused by reduction of power led him to believe that the F/O was correcting back to the flight path as a result of his coaching.
- (4) Until the situation became severe, he had no indication from the F/O that anything was abnormal, since he was unable to **detect** the THS out-of-trim situation.

### C.2.14 Trim operation during out-of-control climb

It is established that the CAP attempted, by intermittently trimming with the control wheel trim switches, and by application of full nose-down elevator control, to correct the abnormally high aircraft pitch attitude. He was unable to apply more than sporadic trim inputs due to the perceived requirement to hold full nose-down elevator input. In this situation the pitch rate could only have been arrested by rolling the aircraft to reduce the lift — a drastic unusual attitude recovery maneuver for which the crew had received no training.

### C.2.15 Stall.

It is established that the aircraft pitch attitude and AOA continued to increase out of control, with a resultant decrease of airspeed until the aircraft stalled. The stall was followed by an uncontrollable steep descent in stalled condition to ground impact.

### C.2.16 Stall Prevention Function in an out-of-trim situation

It is established that activation of the alpha floor function, in a severe out-of-trim situation caused an abrupt increase of the aircraft's pitch angle and was a contributing factor to the subsequent steep climb and stall.

## C.3 Ground impact.

It was established that the aircraft impacted the ground in an almost level attitude resulting in destruction of the aircraft and separation into forward fuselage, wings, aft fuselage horizontal tail plane, vertical tail plane etc..

## C.4 Investigation of Ethanol

It is established that most probable cause for detection of ethanol in the bodies of the CAP and the F/O was post-mortem ethanol production resulting from decomposition. Other possible causes were investigated with inconclusive results

## C.5 China Airlines operations, training and service bulletin processing.

### C.5.1 Operations

It is established that China Airlines had published an Operations Policy Manual, Air Crew Manning Manual and a Dispatch Manual prepared in accordance with Taiwan Civil Aeronautics Administration regulations, and that the aircraft was operated in accordance with these manuals.

### C.5.2 Training

It is established that the CAP and F/O had completed the classroom, simulator and aircraft training based on the training syllabus and Flight Crew Training Material provided by Airbus Industrie in accordance with TAIWAN Civil Aeronautics Administration regulations.



#### C.5.2.1 Simulator Fidelity

It is established that the flight simulator used by China Airlines for recurrent training, which belongs to Thai International Airlines, was never capable of providing training in "misuse of the auto pilot" (AP override) due to the fact that when the AP was overridden the THS autotrimmed in the **wrong** direction — with, as opposed to against, the pilot force input.

#### C.5.3 Service Bulletin Processing

It is established that China Airlines received the service bulletin A300-22-6021 (pertaining to a modification to permit the AP to be disengaged when a 15daN forward force is applied to the control wheel above 400ft radio altitude while in the GO AROUND mode) on July 29, 1993. Since the compliance of the service bulletin was categorized as "Recommended", its implementation was judged to be not urgent and that the modification would be accomplished when FCCs were in need of repair. This modification, therefore, had not yet been incorporated in the aircraft.

### C.6 Automatic Flight System

#### C.6.1 AFS Modifications

It is established that, prior to this accident, several incidents had occurred which had a common phenomenon of falling ultimately into out-of-trim situations.

##### C.6.1.1 Information to the operators

It is established that, with respect to these incidents, the summaries of incidents reported by Airbus to operators as the incidents took place failed to present a systematic explanation of the technical background.

##### C.6.1.2 Service Bulletin Classification

It is established that despite the fact that SB A300-22-6021 was a bulletin with flight safety related implications, developed in response to prior incidents involving hazardous out-of-trim situations, it contained no mention of safety, nor any indication of urgency of installation.

##### C.6.1.3 Service Bulletin Categorization

It is established that even though SB A300-22-6021 was safety related, Airworthiness Directive action by the appropriate airworthiness authorities, (with "Mandatory" category assignment due to safety implications), was not implemented to preclude the recurrence of similar incidents.

#### C.6.2 FCOM description of SB A300-22-6021 modification

It is established that the description in the revision to the FCOM pertaining to the modification of the AFS and the procedure for disengagement of the GO AROUND mode is not easy to understand. Also, the FCOM does not explain with sufficient clarity what is the primary purpose of the AP override function, how the out-of-trim situation is detected, and by what procedure the situation can be avoided.

### C.7 Fire Fighting and Rescue Setup

It is established that the Nagoya Airport had a fire fighting and rescue setup in compliance with the "Level of Emergency Facilities to be Provided" recommended by the Convention to International Civil Aviation, except for the discharge rate of fire extinguishing foam solution.

## Cause Factors

### General

This section contains cause factors of the accident derived from the findings presented in this Appendix. Only those phenomena which **directly** contributed to the accident are included. To the extent possible the causes are listed in an order which is relevant to the progress of the flight.

- C.11 The F/O mistakenly applied forward pressure against the control wheel with the autopilot (AP) engaged in the GO AROUND mode.
- C.12 The Trimmable Horizontal Stabilizer (THS) auto-trimmed against the pilot to produce an out-of-trim condition.
- C.13 The Crew failed to detect and recover from the out-of-trim condition.
- C.14 Although THS motion was normally indicated to the crew by an aural warning, no warning was provided in this case due to the fact that the warning was inhibited by design of the Automatic Flight System in the AP command (CMD) mode.
- C.15 Detection of the onset of the out-of-trim condition was rendered highly improbable, if not impossible by the masking effect of the large out-of-trim condition resulting from increase in thrust to GO AROUND power.
- C.16 A service bulletin (SB A300-22-6021), which was designed to result in AP disconnect if a pitch force in excess of 15daN were applied to the control wheel, was not installed because there was no indication in the bulletin of flight safety implications, or urgency of installation.
- C.17 Although SB A300-22-6021 was developed in response to prior incidents and therefore safety related, Airworthiness Directive action by the appropriate airworthiness authorities was not implemented to preclude the recurrence of similar incidents.
- C.18 The severity of the emergency situation resulting from the out-of-trim condition was critically increased by the absence of a clearly defined emergency procedure to provide a guide for the immediate pilot action required to safely recover.
- C.19 The crew failed to recover from the unusual attitude resulting from the uncontrollable pitch rate due to the cumulative effects of:
  - (1) The out-of-trim condition resulting from Alpha floor function advance of engine thrust to GO AROUND power;
  - (2) The out-of-trim condition resulting from THS full nose-up trim.
- C.20 The crew were not trained to recover from unusual attitudes, because training in the techniques of unusual attitude recovery has, until recently, been neglected by the airline industry (Airlines and Regulatory agencies).

## Synopsis

On April 26, 1994, China Airlines flight CI-140, an Airbus A300B4-622R, with registration number B-1816 took off from Taipei International Airport bound for Nagoya, Japan at 08:53 UTC (17:53 JST). The flight, and approach to landing at Nagoya, was uneventful until 11:14, at which time the aircraft, which was fully configured for landing, deviated upwards from the glide path and levelled off. Shortly afterwards the descent was resumed, but with decreasing speed, and increasing pitch angle and angle of attack. The aircraft slowed to the point where the engines automatically went to maximum power to prevent a stall, and then attempted to execute a GO - AROUND maneuver.

As a result of an extreme out-of-trim configuration caused by the combination of maximum power and the trimmable horizontal stabilizer having moved automatically, without warning, (and therefore undetected by the crew) to the maximum nose-up position, the aircraft climbed with uncontrollable nose-up pitch rate until it stalled, entered a steep descent at below flying speed, and impacted the ground within the confines of the Nagoya airport.

On board the aircraft were 271 persons, 256 passengers (including 2 infants) and 15 crew members, of which 264 persons (249 passengers including 2 infants and 15 crew members) were killed and 7 passengers were seriously injured. The aircraft was destroyed, by impact with the ground and fire.

In the cover letter dated as of July 3, 1996, addressed to Mr. Shoji Sugie, Chief Investigator of Aircraft Accident Investigation Commission of Ministry of Transport, following message is written with the signature of Mr. Lee as the Accredited Representative.

Dear Mr. Sugie,

In addition to our Addendum to the draft report dated as of June 17, 1996 we provide herewith our comments in Japanese on the draft report. Since the original version of the report will be in Japanese, we have concerns regarding the Japanese wording of the report as well as technical aspects of the draft report, on which we discussed in the Addendum. the primary purpose of this additional addendum is to maintain the objectivity of the presentation contained in the draft report.

(Typographical errors in the report are omitted for the purpose of this memorandum)

## I. 2.1 Flight History

In the line 4 of page 2-2, it is stated that "the F/O inadvertently triggered the GO lever".

Comments:

Please compare the above statement with other references to the same subject: "[You] triggered the GO lever" (fourth line from the bottom, page 3-3); "the F/O (P/F) triggered the GO lever" (line 7, page 3-8); "The F/O activated the GO lever" (line 12, page 3-8); "after the F/O had triggered the GO lever" (line 17, page 3-10); "he activated the GO lever" (line 20, page 3-11); "after the F/O triggered the GO lever" (line 4, page 3-13) and "He had inadvertently triggered the GO lever" (line 12, page 3-17).

The word used for "inadvertently" on page 2-2 in the original Japanese is *ayamatte*, which can be interpreted to mean "negligently". In the case of line 12 of page 3-17 mentioned above, a different Japanese word (*fuyôini*) is used to mean "inadvertently". Such word can be understood to mean "without paying attention".

It is not appropriate to use "*ayamatte*" in page 2-2 without discussing the objective reason or relevant facts, because such *ayamatte* is a very subjective word. In fact, some readers may interpret *ayamatte* as "negligently" and others may interpret it as describing as an objective fact that the GO lever did not need to be triggered. The Accident Report should describe the objective facts, and ambiguous wordings which may misleads the readers should be deleted.

## II. 3.1.2.1 Estimation of Flight History

The report renders a statement of the pilot as "It's OK, disengage again slowly, with your hand" at 11:14:30 (on page 3-4).

Comments:

The Japanese phrase used to mean "It's OK" (*iikara*) may imply that the crew was upset and had lost its cool. The original Chinese does not contain such an implication but implies that the crew was in a calm condition. Thus, the Japanese version should be changed to "*daijyobu*", which is more similar to "No problem". The original Chinese phrase can be deemed an evidence to show that the captain's attitude was still calm.

Also, the Report's analysis of the above-mentioned "with your hand" [on?] states that it may mean an instruction to the co-pilot to keep his hand on the button to change from GO AROUND mode to another mode. The original Chinese equivalent to "hand" in the above means palm or whole hand. Since a button would not be pressed with a palm or an entire hand, it is not correct to say that the captain was instructing the co-pilot to change the mode by pushing a button.

## III. 3.1.2.2 Analysis of Flight Conditions

In the last sentence of the last paragraph of 3.1.2.2 (1), the Report states that "the possibility exists for an inadvertent activation of the GO lever during the normal operation of the thrust levers".

Comments:

As mentioned in page 3-2 ("the F/O (PF) was concerned about the wake turbulence" at 1108:26-1110:54), it is clear that CII40 was influenced by wake turbulence created by the aircraft flying ahead. It is possible that the co-pilot's triggering of the GO lever was the inevitable result of a sudden shock caused by the wake turbulence. Since it is impossible to activate the GO lever only by extending the finger from the hand which was set on the thrust lever without another force, it is very likely that some shock caused the co-pilot's finger to activate the GO lever. It is less likely that the pilot activated the GO lever negligently during the normal operation of thrust lever. It is necessary to investigate whether the wake turbulence may have contributed to the activation of GO lever. Thus, it would be more reasonable to include the following statement instead of the one quoted above: "It is possible that the co-pilot triggered the GO lever due to a sudden shock caused by wake turbulence."

IV. 3.1.2.2 (12) Concerning timing of control take-over

In the second paragraph of page 3-15, the Report states that "it is considered that the CAP's situation awareness as PIC for the flight was inadequate, control take-over was delayed, and appropriate actions were not taken".

A similar statement appears on page 3-28: "it is considered that the CAP's judgment situational awareness was inadequate, and that he was delayed in taking over the controls".

Comments:

The statements quoted above are not appropriate. Even if the CAP's situation awareness is deemed by a third party to be inadequate, it is considered that there were various elements resulting in such inadequate situation awareness by CAP, such as night flight, structural problems of the aircraft, delays of situation awareness or other troubles caused by the two-men cockpit system.

Also, it is not clear in what standard the control take over was "delayed".

With respect to "appropriate actions", it is impossible to decide what actions should have been taken at each stage of flight by hearing the CVR recording. Thus, the above-mentioned statements are much misleading and should be deleted.

V. 3.1.10.2 **Training**

The Report states that "F/O underwent simulator training....in the Aeroformation simulator" in 3.1.10.2 (2)(4), on page 3-29.

Comments:

The contents of training to operate aircraft (including the Aircraft) is established by the manufacturer of the aircraft and is instructed to the user airlines. This is because it is the manufacturer that knows the exact details of the structure of the aircraft and there are many aspects of the structure unknown to the user airlines. It is impossible for the airlines to decide whether such is appropriate or to establish its own training menu. China Airlines could not avoid accepting the check-list given by Aeroformation as it was. The Report says the check-list which an instructor of Aeroformation held set forth an item of "Go-around Demonstrate ---", but it means that GO AROUND training in the program was only to demonstrate because it was understood that like SBA300-22-6021, such training did not have the first priority. After the Accident, Airbus added TRIM RUN WAY (UP/DOWN) for pitch directions to the training contents, because the cause of the Accident was strongly related to the OUT OF TRIM condition. (See 3.1.11.4(2)'s reference to the "CAUTION against a hazardous out-of-trim condition that may lead to the hazardous situation if the AP is overridden in pitch direction"). This change of the contents of the training should be referred to in the appropriate portion of the Report (e.g, 3.1.11.4 (5)) in order for the readers of the Report to understand how Airbus, which was to decide the contents of training to operate the Aircraft, changed its recognition in respect of such out-of-trim after the Accident.

Comments:

The descriptions in 3.1.10.2 "(3) AFS Training" on page 3-29 should be amended as follows in order to improve terminology and make clear the subject of each sentence:

1. "The descriptions in FCOM for the AFS" should be amended to "The descriptions in FCOM prepared by the manufacturer for the AFS".
2. "The crew was not given sufficient technical information" should be amended to "The crews of airlines which use the same type of the Aircraft were not given sufficient technical information".
3. "Up-to-date training materials were not properly obtained" should be amended as "Up-to-date training materials were not properly distributed and provided by the manufacturer".

(Unless a manufacturer of aircraft informs, an airlines is unable to recognize an important issue concerning training. Accordingly, the airlines is unable to obtain the relevant material for the training for itself.)

The conclusion ("From the above items it is concluded that the training required to understand the sophisticated and complicated AFS was insufficient") should be amended to read as follows: "From the above items it is concluded that the manufacturer did not provide sufficient training to enable understanding of the sophisticated and complicated AFS." Because the manufacturer did not raise the relevant issues with or provide sufficient training materials to the airlines, the airlines which complied with the instructions from the manufacturer could not provide sufficient training to their pilots. As commented above, the contents of

training concerning operation of aircraft is to be decided, and instructed to an airlines, by the manufacturer and the airlines is to follow such instruction.

VI. 3.1.10.3 **Handling of Service Bulletins**

Comment:

One of the reasons why CAL considered the modification of FCC to be non-urgent is that SEXTANT was not ready to accommodate the request for modification. When CAL asked SEXTANT for such modification before the Accident, it replied that it was not ready to modify the FCC. Accordingly, it was very reasonable for CAL to consider that the modification was not urgent and therefore to decide to carry out the modification at the time when the FCC needed repair.

VII. 3.2.1 **General**

Comment:

It is strongly desirable to add the following sentence in the Report, because the circumstances of the cockpit and conditions of approach at the time of operating the Aircraft heavily affected mental conditions and perception toward the surrounding environmental of the crew members:

"3.2.1.5 The Aircraft was approaching in the night."

VIII. 3.2.2 **Flight Sequence of the Aircraft**

Comment:

Portions of this section shown below should be modified as suggested because the description of flight sequence should avoid subjective judgments unsupported by reasoning. For example, with respect to (5) below, it is reasonable and natural that, in the out-of-trim condition, strong resistive force comes from a control wheel and a pilot continues to push it if the aircraft is in the configuration of nose-up. (Deletions are indicated by ~~strikeout~~, and suggested new text is underlined.)

- (1) While the Aircraft was on ILS approach to Runway 34 of Nagoya Airport at night, under manual control by the F/O(P/F), the F/O ~~inadvertently~~ triggered the GO lever.
- (3) The CAP (PNF) was most likely to have instructed the (F/O) to disengage GO AROUND mode. However, the crew ~~did~~ could not perform an adequate operation to change GO AROUND mode into LAND mode. Consequently the GO AROUND mode was not disengaged.
- (4) There is a possibility that the AP was engaged either by the CAP himself, by the F/O (PF) in accordance with the CAP's (PNF) instructions, or by the F/O ~~without the CAP's consent~~ without notifying the CAP.
- (5) The F/O (PF) continued pushing the control wheel forward, ~~in spite of its~~



~~strong resistive force...~~

IX. 3.2.3 Control and operation by the crew

Comment:

Portions of this section (page 3-44) shown below should be deleted or modified as suggested:

- (1) It is considered that the decision by the CAP and the F/O to change from GO AROUND mode to LAND mode, as well as their subsequent actions to do so, was due to ~~their inadequate~~ the difficulty/impossibility of understanding of the Aircraft AFS.

(The current wording implies that the crew could and should have understood the AFS.)

- (3) It is possible that the CAP did not recognize that the APs were engaged, or that, although he recognized it, he believed he could continuously override the APs. His belief may have arisen from confusion with regard to the supervisory override function of the A300-600R, ~~or from his flight experience in B747.~~

In this regard, the fact that the aircraft was not equipped with a warning function which would alert the crew directly and actively to the THS movement, when the AP was engaged in CMD, is also considered to have had an effect on their judgement and actions.

(The deleted portion constitutes speculation which is not supported by evidence.)

- (4) The F/O did not report to the CAP ~~properly~~ verbally either that he could not change modes or that the Aircraft was not responding as desired (owing to a strong resistive force on the control wheel). Furthermore after the CAP had given further instructions and cautions to the F/O with regard to the mode change, it is not recorded in the CVR that he (the CAP) did not verify verified whether they were being properly followed.

("not --- properly" may well be interpreted to suggest the F/O's negligence. Unless, what concrete actions the pilots could have taken can be indicated, such word (which may result in purely subjective interpretation) should not be used.)

- (5) ~~During approach, the CAP had instructed the F/O to perform PF duty, assigning himself PNF duty. However, after the F/O triggered the GO lever, the CAP disregarded their duty assignment. It is considered that the CAP's judgment of the flight situation as PIC was inadequate, that control take over was delayed, and that appropriate actions were not taken.~~

(With respect to the last sentence, please refer to Comments on 3.1.1 (12) as stacked above. The first and second sentences seems to have no concern with the last sentence. This entire paragraph should be deleted.)

- (6) It is considered that the CAP intended to try to continue the approach when he took control, but that he probably decided to go around when he found he could not stop the pitch angle increasing. Although the aircraft was climbing steeply with pitch angle still rapidly increasing, the CAP seems not to have recognized, even at this time, that the aircraft was in an abnormal THS out-of-trim situation. This could be the reason why the CAP ~~operated Pitch Control Switch only intermittently, and~~ did not reduce the excessively high pitch attitude.

(The deleted portion..... it is very natural reaction by the crew who could not recognize the abnormal situation and this statement is redundant.)

#### 3.2.6.1 Operations

Comment:

The statement from page 3-45 quoted below should be modified as suggested.

The fact that the CAP had allowed the F/O to operate the aircraft on this flight is considered to satisfy the requirements of their crew qualifications, aircraft weight, weather conditions and airport. ~~As described in Paragraph 3.2.3. (5), however, it is considered that the CAP's situational awareness of the flight conditions was inadequate and that control take over was delayed.~~

(Please refer to Comments on 3.1.1 (12) as stated above.)

#### 3.2.6.2 Training

The quotation from page 3-45 of the Report set forth below should be modified as suggested:

However, it is recognized that ~~this training was~~ the preventive measures taken by the manufacturer in this training were not necessarily sufficient to understand the sophisticated and complicated AFS system.

(This change is suggested because the manufacturer did not raise the relevant issues to, and provide sufficient materials with, the airlines and, accordingly, the airlines, which complied with the instructions from the manufacturer, could not provide its pilots with sufficient training.)

#### 3.2.7.2 FCOM

The quotation from page 3-46 of the report set forth below should be modified as suggested:

The contents of "Cautions" added to the FCOM prepared by the manufacturer, the descriptions in the revision to FCOM associated with the AFS modification, and the procedures for disengagement of GO AROUND mode are not easily to understand.

(The author of FCOM should be made clear.)

#### 4. Causes

The descriptions in the Report cited below should be modified as suggested:

##### First Paragraph

While the aircraft was making on ILS approach to runway 34 of Nagoya Airport, under manual control by the F/O, the F/O ~~inadvertently activated~~ touched/triggered the GO lever due to an unknown reason, which changed the FD (Flight Director) to GO AROUND mode and caused a thrust increase. This made the aircraft deviate above its normal glide path.

##### Third Paragraph, Third Sentence

~~The CAP and the F/O did not carry out an effective~~ recovery operation taken by the CAP and the F/O was not effective, and the aircraft stalled and crashed.

##### Factor 1

The F/O ~~inadvertently~~ [*ayamate*] triggered the Go lever. It is considered that the design of the GO lever contributed to it: normal operation of the thrust lever allows the possibility of an ~~inadvertent~~ [*ayamatta*] triggering of the GO lever.

(The word "inadvertently" and, more specifically, the corresponding Japanese word "*ayamate*" may imply negligence. Given the possibility that the lever was hit by accident due to wake turbulence, the description should not go beyond "unintentionally", which would be the more appropriate sense of "inadvertently".)

##### Factor 3

The F/O continued pushing the control wheel in accordance with the CAP's instructions, ~~despite its strong resistive force~~, in order to continue the approach.

(This phrase should be deleted because it may imply that the crew should not have pushed the control wheel. It was a valid decision for the pilots, who had duty to carry out the flight in accordance with the schedule, to continue the scheduled approach. The crew could not recognize the abnormal condition of THS and thus it was reasonable reaction for the crew to push the wheel lever to fix the pitch up movements.)

##### Factor 6

The CAP and F/O ~~did~~ could not sufficiently understand the FD mode change and the AP override function.

Factor 7

~~The CAP's judgment of the flight situation while continuing approach was inadequate, control take over delayed, and appropriate actions were not taken.~~

(Could the Report reveal sufficient proofs to say that the CAP could and should have made "adequate" judgment? "inadequate" is just a subjective judgment without any objective reason. Could the Report reveal sufficient proofs to say that the take over was "delayed"? Could the Report reveal sufficient proofs to say what "appropriate action" the CAP could and should have taken? All of those words may result in purely subjective interpretation without any reason. This phrase should be deleted.)

Factor 9

The CAP's and F/O's ~~awareness of~~ could not be fully aware of the flight conditions and carry out adequately their recovery operation from the abnormal situation, after the PIC took over the controls, ~~was inadequate respectively.~~

6.1 **To the Taiwanese civil aviation authorities**

Comment:

The Report should treat Airbus and CAL in its recommendation equally. In some portions, the attitude of the Report toward CAL is stronger than that shown toward Airbus. For example, the Report recommends that CAL "should reinforce the education and training system for flight crews..." (in the 11th and 12th lines of page 6-1), while Airbus is merely required to "consider incorporating functions to prevent an abnormal out-of-trim condition" (in the 10th line of page 6-2) (emphasis added). Again, the Report should be even-handed in its recommendations to the two companies.

The descriptions in the Report cited below should be modified as suggested:

(1) 2 d.

~~Measures to ensure that through education and training, crews do not activate~~ Investigation of arrangement by which unintended or involuntary activation of the GO-lever of the A300-600R inadvertently can be avoided, and that they take appropriate actions if this occurs.

The reasons of the following three suggestions are not to mislead the reader to assume that the relevant unestablished defects exist.

(3) 1. Standardization of terms

China Airlines should ~~standardize~~ reconfirm standardization of the terms used for instruction...

(3) 2. Procedures of AFS mode change

China Airlines should ~~improve~~ consider the necessity of improving the procedures for mutual confirmation by crews of operation...

(3) 3. Reinforcement of standard call out

China Airlines should ~~ensure~~ consider the necessity of ensuring the implementation of standard call outs in order to enhance...

CAL had carried out civil aviation transportation in accordance with and complying with relevant laws and regulations of the Taiwanese authority regarding maintenance, operation and training. Before the Accident, the Taiwanese authority did not find any defects in the maintenance, operation or training conducted by CAL.

Manufacturers prepare, and provide an airlines with, the contents and manners of training in respect of aircraft. The airlines cannot judge whether such instructions are proper nor prepare their own training measures. Since the Accident, the Taiwanese authority and CAL have reviewed the relevant laws and regulations and the contents of the training program prepared and notified by the manufacture and have taken necessary measures to cover the defects which were neither expected nor foreseeable prior to the Accident.

As described in the Report, CAL satisfied the requirements pursuant to the relevant laws and regulations and complied with the training program prepared by the manufacturer. The Taiwanese authority understands that the safety recommendation regarding the reinforcement of education and training is to improve the training system of CAL after the Accident and not to point out defects in the training system prior to the Accident.

**Notice from the USA**



**National Transportation Safety Board**

Washington D.C. 20594

May 28, 1996

Mr. Shoji Sugie  
Investigator-In-Charge  
Aircraft Accident Investigation  
Commission of Japan  
Japanese Ministry of Transport  
2-1-3, Kasumigaseki, Chiyoda-ka  
Tokyo 100, Japan

Dear Mr. Sugie:

We have finished our review of your draft final report of the China Airlines A300 accident investigation. The report was a very thorough review of the accident sequence of events and underlying reasons why the accident occurred. We have no substantive comments on this draft and look forward toward receiving the final report upon its publication.

Please let us know if we can be of any more assistance.

Sincerely,

A handwritten signature in black ink, appearing to read "Robert Benzon". The signature is stylized and includes a large, sweeping flourish at the end.

Robert Benzon

U.S. Accredited Representative